

NEW PRODUCT GUIDE



2 0 1 4



AX322NM

Amerex's CARBON DIOXIDE (CO₂) PORTABLE FIRE EXTINGUISHERS effectively fight Class B flammable liquid fires and are electrically non-conductive with a clean, non-contaminating, and odorless gas. They are perfectly safe for use on clothing, equipment, valuable documents, and food. FM approved. USCG approved with bracket listed on the UL label.

| P/N | SHIP. WEIGHT | UNIT HEIGHT | UNIT WIDTH | SHELL DIAM-ETER | HEAVY-DUTY BRACKET P/N |
|-----------|-----------------------------------|----------------------------------|---------------------------------|----------------------------------|------------------------|
| → AX320 | 8 ⁷ / ₈ lbs | 13 ³ / ₄ " | 7 ¹ / ₄ " | 14 ³ / ₈ " | - |
| → AX320NM | 8 ⁷ / ₈ lbs | 13 ³ / ₄ " | 7 ¹ / ₄ " | 14 ³ / ₈ " | - |
| → AX322NM | 14 lbs | 17 ³ / ₄ " | 8 ¹ / ₄ " | 5 ¹ / ₄ " | - |

| P/N | DESCRIPTION | UL RATING |
|-----------|--|-----------|
| → AX320 | 2 ¹ / ₂ lb w/ Wall Hanger | 2B:C |
| → AX320NM | 2 ¹ / ₂ lb Non-Magnetic w/ Wall Hanger | 2B:C |
| → AX322NM | 5 lb Non-Magnetic w/ Wall Hanger | 5B:C |



FES2



FMRGC

The **FireTech™ FIBERGLASS STAND** is designed for use with **FGC26 Fiberglass Cabinet**. Its red finish perfectly matches the cabinet and it comes with four pre-drilled holes for permanent attachment to docks or other locations. There are also mounting holes and hardware for attaching the cabinet. Sand can be added as well, for temporary placement. Measures 27¹/₂" tall with a 15¹/₂" x 15¹/₂" base and 8¹/₄" x 11³/₄" top surface.

| P/N | DESCRIPTION |
|--------|---|
| → FES2 | Fiberglass Cabinet Stand For FGC26 Cabinet |

The **Original Firemate™** is a stackable, **PORTABLE FIRE EXTINGUISHER STAND** that's made of tough HDPE plastic. The stand holds 5, 10, or 20 pound extinguishers and its wide base resists tipping. OSHA compliant. Red.
NOTE: Fire extinguisher not included.

| P/N | DESCRIPTION |
|---------|----------------------------------|
| → FMRGC | Portable Fire Extinguisher Stand |



SL45861



SL45877

E-Spot® Firebox® LANTERNS, from **Streamlight®**, feature three shockproof **C4®** LEDs with a 50,000 hour lifetime and up to 615 lumens. Also their jumper selectable high and low settings allow selection of more light output or more runtime. Other features include an ABS thermoplastic housing, rubberized impact bumper, lens ring, and cushion-grip handle. A toggle switch makes use with gloves a snap too.

| P/N | DESCRIPTION |
|-----------|---|
| → SL45861 | E-Spot Firebox Standard System Flashlight, 11 ¹ / ₂ "L x 7"H x 5 ¹ / ₈ "W, Orange/Black Includes: 120VAC, 12V Chargers, Shoulder Strap & Mounting Rack |
| → SL45877 | E-Spot Firebox Standard System Flashlight, 11 ¹ / ₂ "L x 7"H x 5 ¹ / ₈ "W, Yellow/Black Includes: 120VAC, 12V Chargers, Shoulder Strap & Mounting Rack |

The bright, right-angled **Survivor® LED FLASHLIGHT** from **Streamlight®**, is a lightweight hand-held flashlight, designed for use in hazardous situations. It uses **C4 LED™** technology for exceptional power. The **Survivor® LED** is also water resistant and has microprocessor-controlled high and low lighting modes, including a Moonlight mode and Emergency Flash mode.

| P/N | DESCRIPTION |
|-----------|--|
| → SL90513 | Survivor LED Flashlight, 120VAC/DC, Yellow Includes: Steady Charger |
| → SL90503 | Survivor LED Flashlight, 120VAC/DC, Orange Includes: Steady Charger |
| → SL90500 | Survivor LED Flashlight (only), DC, Orange |
| → SL90541 | Survivor LED Flashlight (only), Alkaline, Yellow |
| → SL90540 | Survivor LED Flashlight (only), Alkaline, Orange |

For nearly a century, people have relied on **NFPA® PUBLICATIONS**—your blueprints to safety.

| P/N | DESCRIPTION |
|------------|---|
| → NFPA9614 | NFPA 96: Standard for Ventilation Control & Fire Protection of Commercial Cooking Operations, 2014 ed |

Nemesis™ SAFETY GLASSES offer a sleek, sporty style that's designed for safety and comfort. Lightweight with flex temples for an effortless fit. Single, wraparound lens offers excellent impact protection too. Comes with a neck cord to keep them handy. Meets ANSI Z87.1+ standards. 99.9% UV protection.

| P/N | DESCRIPTION |
|----------|---|
| → NEMCAF | Black Frame w/ Clear Anti-Fog Lens |
| → NEMSAF | Black Frame w/ Smoke Mirror Anti-Fog Lens |

LAW® OTG (Over The Glass) PROTECTIVE EYEWEAR features durable dielectric nylon frames with five-position ratcheting temples. They also include an exclusive Duramass® scratch-resistant coating and non-slip temple inserts. Silver temple. Meets ANSI impact standards and blocks 99.99% of harmful UV rays.

| P/N | DESCRIPTION |
|------------|---------------------|
| → 0G110AFC | Clear Anti-Fog Lens |
| → 0G112AFC | Gray Anti-Fog Lens |



SL90503

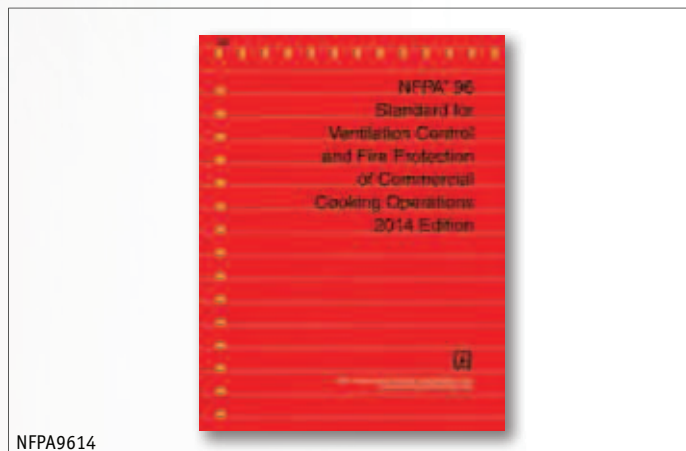

NFPA9614



NEMSM



0G112AFC



MSG2

SPRINKLER GAUGES are manufactured to exact standards, with only the finest materials, for maximum performance year in and year out. Designed for wet or dry sprinkler systems. UL listed and FM approved.

Metal-Backed **GAUGES** (4")

| P/N | DESCRIPTION |
|--------|---|
| → MSG1 | Air Gauge, 0–80 (Water Retard to 250 psi) |
| → MSG2 | Water Gauge, 0–300 psi |
| → MSG3 | Air/Water Gauge, 0–300 psi |



SGIL

Help your customers comply and show the AHJ that sprinkler gauges have been tested/replaced (within the 5 year period by NFPA 25) with the **SPINKLER GAUGE INSTALLATION LABEL**. Label

includes spaces to record the installation date (which is different from the manufacturer date) and the date to test or replace the gauge.

| P/N | DESCRIPTION |
|--------|--|
| → SGIL | Sprinkler Gauge Installation Label, Roll/300 |



SGVK

The **SPRINKLER GAUGE VALVE KIT** is perfect for sprinkler systems without 3-way valves or ones that need replacing. **SGVK** comes with three 1/4" nipples (2 1/2", 4", and 6"), a 1/2" x 1/4" reducing bushing, a brass 2-way valve, and a 1/4" plug. **TWGV25** allows gauge replacement without shutting off the water.

| P/N | DESCRIPTION |
|---------|--|
| → SGVK | 3-Way Gauge Valve Kit |
| → SGKP_ | 3-Way Gauge Valve Kit w/ Plastic Gauge |
| → SGKM_ | 3-Way Gauge Valve Kit w/ Metal Gauge |
| → BP47 | 1/4" x 1/2" Black Bushing |



HDVTS18

The **HEAVY-DUTY VALVE TAMPER SEALS** are both deterrents and indicators of the unauthorized opening or closing of the sprinkler system valves. They meet the installation requirements of NFPA 13 and inspection requirements of NFPA 25 for sprinkler systems too. (Attach seals to valves in a manner that the valves cannot

be operated without breaking the seals.) Each seal is stamped with a 7-digit serial number that can be recorded to show who performed the installation, inspection, or maintenance. **IMPRINT SEAL** is available with 3-lines, 8 characters per line. Minimum 3,000. Matted in strips of 10 for ease-of-use. Sold in boxes of 1,000.

NOTE: When seals are used, valves should be inspected weekly.

| P/N | DESCRIPTION |
|--------------|--|
| → HDVTS18 | Heavy-Duty Valve Tamper Seals, 18" |
| → SSPHDVTS18 | Imprint Heavy-Duty Valve Tamper Seals, 18" |



HDVTS18 In Use

Power Rite® ALARM BATTERIES are tough, long lasting, and powerful.

| P/N | DESCRIPTION | L X H X W | CASE QTY |
|--------------|-------------|--|----------|
| → PRB1218NB* | 12V, 18AH | 7 ¹ / ₈ " x 6 ⁹ / ₁₆ " x 3" | 2 |
| → PRB1226NB* | 12V, 26AH | 6 ⁹ / ₁₆ " x 4 ¹⁵ / ₁₆ " x 6 ⁷ / ₈ " | 1 |
| → PRB1275NB* | 12V, 75AH | 10 ¹ / ₄ " x 8 ¹ / ₈ " x 6 ³ / ₈ " | 1 |

*INCLUDES NUT AND BOLT CONNECTION

Power-Sonic BAT SERIES REPLACEMENT BATTERIES—unparalleled reliability at a reasonable price.

| P/N | DESCRIPTION | L X H X W | CASE QTY |
|---------------|-------------|--|----------|
| → BAT1226 | 12V, 26AH | 6 ⁹ / ₁₆ " x 4 ¹⁵ / ₁₆ " x 7" | 1 |
| → BAT1233NB* | 12V, 33AH | 7 ¹³ / ₁₆ " x 6 ¹ / ₄ " x 5 ³ / ₁₆ " | 1 |
| → BAT1255NB* | 12V, 55AH | 9 ¹ / ₁₆ " x 8 ¹ / ₈ " x 5 ⁷ / ₁₆ " | 1 |
| → BAT1275NB* | 12V, 75AH | 10 ¹ / ₄ " x 8 ¹ / ₈ " x 6 ³ / ₈ " | 1 |
| → BAT12100NB* | 12V, 100AH | 12 ¹³ / ₁₆ " x 9 ³ / ₈ " x 6 ⁷ / ₈ " | 1 |

*INCLUDES NUT AND BOLT CONNECTION

The **Gold-Plus BATTERY TESTER** is designed to test the most common 6V (1.2AH to 12AH) and 12V (1.2AH to 100AH) lead acid batteries. Quick and easy to use, it displays DC voltage and AH capacity in seconds. Simply choose the battery type and then press "Test". No confusing conversion rates to worry about either—you get the battery's DC voltage followed by the actual AH capacity. This method is also significantly more accurate than measuring voltage and internal resistance. Plus the **Gold-Plus** does not deplete the battery like conventional load testers.

| P/N | DESCRIPTION |
|------------|-----------------------|
| → BACTPLUS | 6V/12V Battery Tester |

Kidde's front-loading 120VAC **CO/PHOTOELECTRIC SMOKE ALARM**, with 9V battery backup, offers protection against both fire and carbon monoxide in a single unit. It also issues audible warnings—"Fire! Fire!" or "Warning! Carbon Monoxide!". A front-loading battery tray makes replacement simple too. Battery included.

| P/N | DESCRIPTION |
|------------|---------------------------|
| → 21007624 | Combo Photoelectric Alarm |

Custom-imprinted **SELF-INKING STAMP KIT** comes complete with everything you need—stamp, ink, and dry cartridge. Easily stamps standard and coated cardstock. Stamp also features clear positioning window for accurate positioning and replaceable ink cartridges. **STAMP1** offers 2,500 impressions and **STAMP2** 8,000 impressions per bottle of ink. Signed proof must be received before order is processed. Allow one week for delivery.

| P/N | DESCRIPTION |
|-----------------|---|
| → STAMP1HOUSING | Replacement Housing for STAMP1 |
| → STAMP2HOUSING | Replacement Housing for STAMP2 |
| → DIC1 | Dry Ink Cartridge for STAMP1 |
| → DIC2 | Dry Ink Cartridge for STAMP2 |
| → BTI | Black Textile Ink, 2 oz |
| → CUSTOMSTAMP1 | Custom Stamp, 1 ¹ / ₂ " x 3" |
| → CUSTOMSTAMP2 | Custom Stamp, 3 ³ / ₄ " x 1 ⁷ / ₈ " |



BACTPLUS



21007624



CUSTOMSTAMP1

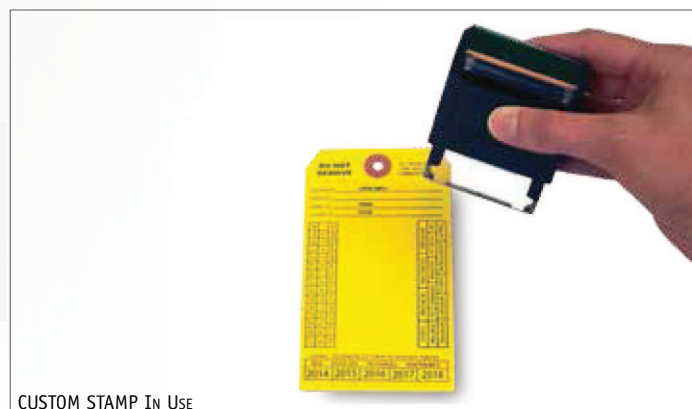

CUSTOM STAMP In Use



CPH2



TRPTR1250BMP

BucketBoss® HOLSTERS incorporate dense foam padding and a spring steel clip. **CPH2** fits many newer phones, including **Galaxy S3®** and all **iPhones®**.

| P/N | DESCRIPTION | H X W X D |
|--------|--------------------|----------------------|
| → CPH2 | Cell Phone Holster | 6 1/2" x 3" x 1 3/4" |

This **TWISTED TRUCK ROPE** features combined premium polypropylene yarns for exceptional balance and strength. Plus it's resistant to rot, mildew, oils, gas, and most chemicals. Black/Orange.

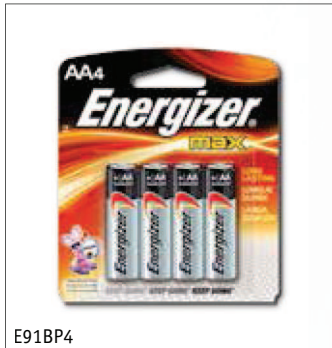

E91BP4



E93BP2

| P/N | DESCRIPTION |
|----------------|---|
| → TRPTR12100PB | Medium-Duty Truck Rope (Bag), 3/8" x 50' |
| → TRPTR1250BMP | Medium-Duty Truck Rope (Bag), 3/8" x 100' |

Energizer® Max® ALKALINE BATTERIES are designed for long-lasting performance in a broad spectrum of devices. They also have a long shelf life—10 years—so they're fresh when needed. And no added mercury means they can go out with the garbage.

| P/N | DESCRIPTION |
|----------|--------------------------------|
| → E91BP4 | Max AA Alkaline Battery, Pkg/4 |
| → E93BP2 | Max C Alkaline Battery, Pkg/2 |



66118

The **Stylus Pro™ PENLIGHT** features **C4®** LED technology for blindingly bright light; compact, durable construction; optimum beam output; and a tailswitch for single-handed operation. It's also corrosion-resistant, water-resistant, shockproof, and o-ring sealed with an unbreakable lens. Comes with two AAA alkaline batteries. Black.

| P/N | DESCRIPTION |
|---------|---------------------|
| → 66118 | Stylus Pro Penlight |



66318

Streamlight's proprietary **Micro Optical System (MOS)** is the magic behind the blinding white light of their **MicroStream® PENLIGHT**. Its 30,000-hour high-flux LED provides up to 28 lumens. Plus it's tough, thanks to an aircraft aluminum housing with an internal polymer liner and shockproof switch. It's also o-ring sealed and comes with an unbreakable polycarbonate lens. Uses one AAA alkaline battery (included). Black.

| P/N | DESCRIPTION |
|---------|----------------------|
| → 66318 | MicroStream Penlight |



TUFPAL31E

For the toughest demands in portable lighting, the **Energizer® Hard Case® Professional® LED AREA LIGHT** features wide-angle LEDs that deliver a broad area of light. It also has two mounting options—magnet mount or solid surface mount. To operate, simply push the lens. Comes complete with three AA **Energizer Max®** batteries. Black.

| P/N | DESCRIPTION |
|-------------|------------------------------|
| → TUFPAL31E | Hard Case Pro LED Area Light |

Waypoint™ SPOTLIGHTS feature a pistol grip and trigger switch that make them easy to point and shine powerful light on an exact spot. IPX4 rated and water resistant, these spotlights have an integrated stand for hands-free lighting. They're tough, too, thanks to high-impact housings. Other features include **C4®** LEDs, unbreakable lenses, and light weight, which make the **Waypoint Spotlight** a "go-to" piece for tool box, tool belt, and more. Batteries sold separately.

| P/N | DESCRIPTION |
|---------|--|
| → 44900 | Waypoint Pistol Grip Spotlight w/ 12V Cord & Polymer Storage Mount, Yellow |
| → 44902 | Waypoint Pistol Grip Spotlight w/ 12V Cord & Polymer Storage Mount, Black |



44900

Featuring dual power sources, the **Energizer® SOLAR FOLD-ING LANTERN** operates on solar energy (charges even in low light) or on three D-cell alkaline batteries. What's more, in addition to solar charging. And it's flexible, folding out for 180° or 360° of bright light. Runs up to five hours (solar) or 165 hours (alkaline batteries). Orange.

| P/N | DESCRIPTION |
|-------------|-----------------------|
| → SOLRE35BP | Solar Folding Lantern |



SOLRE35BP

Ductmate® DUCT ACCESS DOORS are UL1978 listed and meet NFPA 96 standards. Easy to install, no welding, drilling or special tools needed saving installation time. Available in a variety of sizes and includes a self-adhesive template for the duct opening to be used. Consists of two layers of 11 gauge steel (S.S. also available) and a high temperature ceramic board rated to 2,300°.

NOTE: For steel duct use only!

| P/N | DESCRIPTION | DOOR SIZE | MAX TEMP RATING |
|-------------|-------------|-----------|-----------------|
| → D106ULBI | Rectangle | 10" x 6" | 2,300° |
| → D1010ULBI | Rectangle | 10" x 10" | 2,300° |
| → D128ULBI | Rectangle | 12" x 8" | 2,300° |
| → D1814ULBI | Rectangle | 18" x 14" | 2,300° |



D106ULBI



651S

EMT CONDUIT FITTING

- | P/N | DESCRIPTION |
|--------|--|
| → 651S | 1/2" Steel Compression Connector (Sold Individually) |



TL1228



TL1218 IN USE

The **Jiffy Seal RATCHETING WRENCH** is an ingenious tool that tightens/loosens hex nuts and bodies in ventilation hoods. Its unique design fits into tight spaces easily and works with any 3/8" drive flexible T-handle. Made of heat-treated steel with carbonitride/zinc plating, the wrench automatically finds the right slot angle and indexes to the next position when in use. Wrenches and driver sold separately.

- | P/N | DESCRIPTION |
|----------|--|
| → TL388 | 1 1/2" Ratcheting Wrench For 3/8" and 1/2" Penetration Seals w/ 1 1/8" Hole |
| → TL1218 | 8" Crimping Tool For 3/8" and 1/2" Penetration Seals w/ 3/8" Hole |
| → TL1228 | 3/8" Drive Flexible T-Handle |



AX16444



AX12506

Amerex® CORNER PULLEYS.

- | P/N | DESCRIPTION |
|-----------|---------------------------|
| → AX16444 | Compression Corner Pulley |
| → AX12506 | Tee Pulley |

Ansul® CORNER PULLEYS.

- | P/N | DESCRIPTION |
|------------|-------------|
| → TY427929 | Tee Pulley |

Badger™ Range Guard® CORNER PULLEYS.

- | P/N | DESCRIPTION |
|-----------|-------------|
| → B843792 | Tee Pulley |

Kidde CORNER PULLEYS.

- | P/N | DESCRIPTION |
|-----------|-------------|
| → K843792 | Tee Pulley |

Pyro-Chem® CORNER PULLEYS.

- | P/N | DESCRIPTION |
|------------|-------------|
| → TY427929 | Tee Pulley |



TY427929



B843792

AMEREX KITCHEN SYSTEM PARTS

ENCLOSURES, TANKS, and BRACKETS.

| P/N | DESCRIPTION |
|-------------|--|
| → AX16921 | Model 2.75 Agent Cylinder, Filled & Charged |
| → AX13334 | Model 3.75 Agent Cylinder, Filled & Charged |
| → AX17379 | Model 4.75 Agent Cylinder, Filled & Charged |
| → AX15196 | Model 6.14 Agent Cylinder, Filled & Charged |
| → AX16920 | Bracket for 2.75, 3.75 & 4.75 gal Cylinder (w/ Swivel Adapter) |
| → AX17690 | Bracket for 3.75 gal Cylinder (w/ Swivel Adapter) |
| → AX21583 | Bracket for 6.14 gal Cylinder (w/ Swivel Adapter) |
| → ✓ AX18000 | MRM II w/ Red Enclosure |
| → ✓ AX18001 | MRM II w/ SS Enclosure |
| → ✓ AX10147 | Pneumatic Actuator |
| → AX10199 | Discharge Adapter Kit, 6.14 gal Cylinder |
| → AX10173 | Vent Check |
| → AX17484 | Low Pressure Module |

✓ **Authorized Distributors Only**

CARTRIDGE

| P/N | DESCRIPTION |
|-----------|------------------------------|
| → AX12856 | Nitrogen Actuation Cartridge |

CHEMICAL

| P/N | DESCRIPTION |
|-----------|-------------------------------|
| → AX16924 | Amerex Wet Chemical, 2.75 gal |
| → AX12866 | Amerex Wet Chemical, 3.75 gal |
| → AX17450 | Amerex Wet Chemical, 4.80 gal |
| → AX15416 | Amerex Wet Chemical, 6.14 gal |

MICROSWITCHES

| P/N | DESCRIPTION |
|-----------|--|
| → AX12524 | SPDT Snap Action Microswitch w/18" Leads |
| → AX18312 | Alarm Microswitch |

NOZZLES

| P/N | DESCRIPTION |
|-----------|----------------------------|
| → AX16440 | Nozzle Swivel Adapter |
| → AX13729 | Fryer, Griddle |
| → AX11982 | Appliance, Plenum |
| → AX11983 | Solid Fuel, Charbroiler |
| → AX11984 | Upright, Charbroiler |
| → AX16416 | Duct |
| → AX14178 | Zd, 4 Burner Range/Griddle |
| → AX17461 | Backshelf Manifold |

NOZZLE CAPS

| P/N | DESCRIPTION |
|-----------|--------------------------------|
| → AX12334 | Blow Off Cap, Standard |
| → AX12504 | Blow Off Cap, High Temperature |



AX13334



AX18000

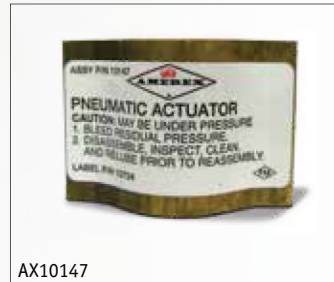

AX10147



AX10173



AX12856



AX12866



AX12524



AX18312



AX16440



AX11982



AX16416

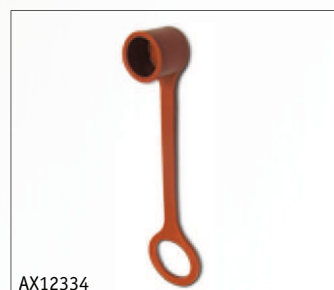

AX12334

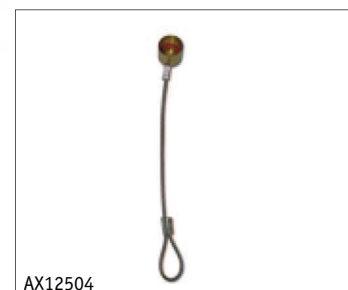

AX12504



AX12508

DETECTORS and PARTS.

| P/N | DESCRIPTION |
|-----------|--|
| → AX12508 | Detector Assembly (Bracket, Linkage, & Conduit Fittings) |



AX12309

CORNER PULLEYS

| P/N | DESCRIPTION |
|-----------|----------------------|
| → AX12309 | Amerex Corner Pulley |
| → AX12506 | Tee Pulley |



AX12506



AX12740



GAS VALVES and ACCESSORIES.

| P/N | DESCRIPTION |
|-----------|-----------------------------|
| → AX12790 | 3/4" Mechanical Gas Valve |
| → AX12791 | 1" Mechanical Gas Valve |
| → AX12792 | 1 1/4" Mechanical Gas Valve |
| → AX12793 | 1 1/2" Mechanical Gas Valve |
| → AX12794 | 2" Mechanical Gas Valve |
| → AX13622 | Gas Valve Actuator Kit |
| → AX12740 | Gas Valve Trip Assembly |



AX21481

MANUAL PULL STATIONS

| P/N | DESCRIPTION |
|-----------|---|
| → AX21481 | Manual Pull Station (Recess or Surface Mount) |

SERVICE TOOLS

| P/N | DESCRIPTION |
|-----------|----------------------|
| → AX12738 | Set-Up/Lock-Out Tool |
| → AX13341 | Cocking Tool |
| → AD36 | Recharge Adapter |
| → AX12855 | "T" Handle Adapter |

SERVICE MANUAL

| P/N | DESCRIPTION |
|-----------|----------------|
| → AX20150 | Service Manual |

ANSUL KITCHEN SYSTEM PARTS

AUTOMANS and TANKS.

| P/N | DESCRIPTION |
|-------------|---|
| → ✓ A429853 | Mechanical Automan* |
| → ✓ A429856 | Ansul Electrical Automan* |
| → ✓ A429859 | Ansul 24V Automan* |
| → ✓ A429850 | Regulated Actuator & Enclosure |
| → ✓ A79493 | OEM Mechanical Regulated Release |
| → ✓ A418054 | OEM Electric Regulated Release |
| → ✓ A418691 | OEM Regulated Actuator w/ Bracket |
| → ✓ A418522 | OEM Regulated Actuator w/o Bracket |
| → A429870 | Stainless Steel Enclosure (Only) |
| → A429872 | Two Tank Stainless Steel Enclosure (Only) |
| → A429864 | 1.5 gal Stainless Steel Tank |
| → A429862 | 3 gal Stainless Steel Tank |
| → A429878 | 3 gal Stainless Steel Tank Bracket |

*ORDER TANKS AND CARTRIDGES SEPARATELY.

✓ **Authorized Distributors Only**

CARTRIDGES and CAPS.

| P/N | DESCRIPTION |
|----------|------------------------------------|
| → A77251 | LH Threaded Cartridge Shipping Cap |

CHEMICAL

| P/N | DESCRIPTION |
|-----------|----------------------|
| → A79694 | Ansulex, 1 1/2 gal |
| → A426199 | Ansulex, 55 gal Drum |

MICROSWITCHES

| P/N | DESCRIPTION |
|-----------|------------------|
| → A423878 | SPDT Microswitch |
| → A423879 | DPDT Microswitch |
| → A423880 | 3PDT Microswitch |
| → A423881 | 4PDT Microswitch |



AX13341



AX12855



AX20150



A429853



A429862



A428311



A434455

NOZZLES

| P/N | DESCRIPTION |
|-----------|------------------------|
| → A434455 | Henny Penny Nozzle Kit |



TY427929



A55601

CORNER PULLEYS

| P/N | DESCRIPTION |
|------------|-------------------------------|
| → A415670 | Ansul Set Screw Corner Pulley |
| → TY427929 | Ansul/Pyro-Chem Tee Pulley |

GAS VALVES and ACCESSORIES.

| P/N | DESCRIPTION |
|----------|-------------------------------------|
| → A55598 | 3/4" Mechanical Gas Valve (Ansul) |
| → A55601 | 1" Mechanical Gas Valve (Ansul) |
| → A55604 | 1 1/4" Mechanical Gas Valve (Ansul) |
| → A55607 | 1 1/2" Mechanical Gas Valve (Ansul) |
| → A55610 | 2" Mechanical Gas Valve (Ansul) |
| → A15733 | Pneumatic Piston Kit (Ansul) |

**ANSUL VALVES INCLUDE THE ACTUATOR CYLINDER. ORDER P/N A15733 SEPARATELY FOR THE ASCO VALVES.



A435725



A435726

REMOTE PULL STATIONS and ACCESSORIES.

| P/N | DESCRIPTION |
|-----------|---|
| → A435960 | Remote Pull Station w/ 50' Cable |
| → A435725 | Bearing & Bolt, Pkg/10 For Remote Pull |
| → A435726 | Pull Tabs, Pkg/10 For A436618 |



A435979



A434347

FLEXIBLE CONDUIT and ACCESSORIES.

| P/N | DESCRIPTION |
|-----------|--|
| → A434525 | Flexible Conduit, 500' |
| → A435959 | Flexible Conduit w/ Wire Rope, 500' |
| → A435979 | Flexible Conduit Strain Relief, Pkg/50 |
| → A434347 | Flexible Conduit Inserts, Pkg/50 |
| → A436150 | P-Clip, Pkg/50 |
| → A436063 | Conduit Offset, Pkg/6 |

SERVICE TOOLS

| P/N | DESCRIPTION |
|-----------|-------------|
| → A438031 | Locking Pin |

KIDDE AND BADGER RANGE GUARD SYSTEM PARTS

CYLINDERS, CONTROL HEADS, and BRACKETS.

| P/N | DESCRIPTION |
|--------------|--|
| → K120001 | Kidde WHDR-125 Charged Cylinder, 1.25 gal |
| → B120001 | Badger WHDR-125 Charged Cylinder, 1.25 gal |
| → K120002 | Kidde WHDR-260 Charged Cylinder, 2.6 gal |
| → B120002 | Badger WHDR-260 Charged Cylinder, 2.6 gal |
| → K120003 | Kidde WHDR-400S Charged Cylinder, 4 gal |
| → B120003 | Badger WHDR-400S Charged Cylinder, 4 gal |
| → K120006 | Kidde WHDR-400M Charged Cylinder, 4 gal |
| → B120006 | Badger WHDR-400M Charged Cylinder, 4 gal |
| → K120005 | Kidde WHDR-600 Charged Cylinder, 6 gal |
| → B120005 | Badger WHDR-600 Charged Cylinder, 6 gal |
| KR844908 | Discharge Adapter Kit |
| → ✓ K1200992 | Kidde New XV Control System |
| → ✓ B1200992 | Badger New XV Control System |
| → ✓ K1200101 | Kidde KRS 50 Control Box Assembly |
| → ✓ B1200101 | Badger KRS 50 Control Box Assembly |
| → KR045001 | High-Pressure Hose, 7½" |
| → KR045002 | High-Pressure Hose, 24" |
| → KR045003 | High-Pressure Hose, 60" |
| → KR9197430 | Wall Bracket, 1.25 gal Cylinder |
| → KR9197263 | Wall Bracket, 2.6 gal Cylinder |
| → KR9197415 | Wall Bracket, 4 gal Short Cylinder |
| → KR9197414 | Wall Bracket 4 gal Medium Cylinder |
| → KR100013 | Shelf Bracket, 4 & 6 gal Med Cylinders |
| → KR100010 | Floor Mtg Kit, 4 & 6 gal Med Cylinders Requires KR 100013 Shelf Bracket |

✓ AUTHORIZED DISTRIBUTORS ONLY

MICROSWITCHES

| P/N | DESCRIPTION |
|------------|---------------------------------------|
| → KR120039 | SPDT Microswitch System XV Control |
| → KR97227 | SPDT Microswitch KRS-50 |
| → KR97228 | DPDT Microswitch KRS-50 |

DETECTORS

| P/N | DESCRIPTION |
|------------|---------------------------------|
| → KR804548 | Link Detector Kit XV Control |
| → KR120064 | Universal Link Detector Kit |

CORNER PULLEYS

| P/N | DESCRIPTION |
|------------|--------------------------------|
| → KR843792 | Kidde/Badger Double Tee Pulley |

GAS VALVES

| P/N | DESCRIPTION |
|------------|--------------------------|
| → KR100001 | ¾" Mechanical Gas Valve |
| → KR100002 | 1" Mechanical Gas Valve |
| → KR100003 | 1¼" Mechanical Gas Valve |
| → KR100004 | 1½" Mechanical Gas Valve |
| → KR100005 | 2" Mechanical Gas Valve |
| → KR100006 | 2½" Mechanical Gas Valve |
| → KR100007 | 3" Mechanical Gas Valve |

ACCESSORIES

| P/N | DESCRIPTION |
|------------|-------------------------------|
| → KR237167 | Piercing Pin, Yellow, Pkg/10 |
| → KR197215 | Piercing Pin, (KRS50), Pkg/10 |



K120001



B120001



K1200992



B1200101



KR844908



BA120039



KR100001



PC551194



PC550853



PC550104

PYRO-CHEM KITCHEN SYSTEM PARTS

CYLINDERS, ENCLOSURES, and BRACKETS.

| P/N | DESCRIPTION |
|------------|---|
| → PC551194 | PCL 300 Charged Cylinder, 3 gal |
| → PC551193 | PCL 460 Charged Cylinder, 4.6 gal |
| → PC551196 | PCL 600 Charged Cylinder, 6 gal |
| → PC550053 | MB-1 Cylinder Bracket |
| → PC550054 | MB-15 Cylinder Bracket |
| → PC550966 | EN-S Enclosure For Secondary Cylinders |
| → PC550853 | MB-P2 Control Head Mounting Bracket |
| → PC550104 | PAC-10 Pneumatic Actuating Cylinder |
| → PC550093 | PAC-100 Pneumatic Actuating Cylinder |
| → PC550829 | Pneumatic Actuating Adapter |

CARTRIDGE

Actuator cartridges and o-rings must be periodically replaced in accordance with the **Pyro-Chem®** manual. Refer to manual for replacement intervals and installation instructions.

TIP: Make sure to check cartridge weight before installation.

| P/N | DESCRIPTION |
|------------|---|
| → PC551059 | 16gm CO ₂ Actuator Cartridge (Sold Individually) |



PC551059

CHEMICAL

| P/N | DESCRIPTION |
|------------|--------------------------------|
| → PC553176 | RL-160, 1.6 gal Recharge Agent |

MICROSWITCHES

| P/N | DESCRIPTION |
|------------|-----------------------------|
| → PC551154 | SPDT Microswitch, MCH3 Head |
| → PC551155 | DPDT Microswitch, MCH3 Head |
| → PC551156 | 3PDT Microswitch, MCH3 Head |
| → PC551157 | 4PDT Microswitch, MCH3 Head |



PC551154



PC550131

DETECTORS and PARTS.

| P/N | DESCRIPTION |
|------------|-----------------------------|
| → PC550131 | FLK-1 Link Bracket Kit, 10" |
| → PC550132 | FLK-1A Link Bracket Kit, 8" |

CORNER PULLEYS

| P/N | DESCRIPTION |
|------------|--------------------------|
| → PC415670 | Corner Pulley, Set Screw |

GAS VALVES

| P/N | DESCRIPTION |
|------------|-----------------------------|
| → PC550593 | 3/4" Mechanical Gas Valve |
| → PC550594 | 1" Mechanical Gas Valve |
| → PC550595 | 1 1/4" Mechanical Gas Valve |
| → PC550596 | 1 1/2" Mechanical Gas Valve |
| → PC551049 | 2" Mechanical Gas Valve |
| → PC550185 | 2 1/2" Mechanical Gas Valve |
| → PC550186 | 3" Mechanical Gas Valve |



PC550595

REMOTE PULL STATION

| P/N | DESCRIPTION |
|------------|------------------------|
| → PC551166 | Electrical Remote Pull |

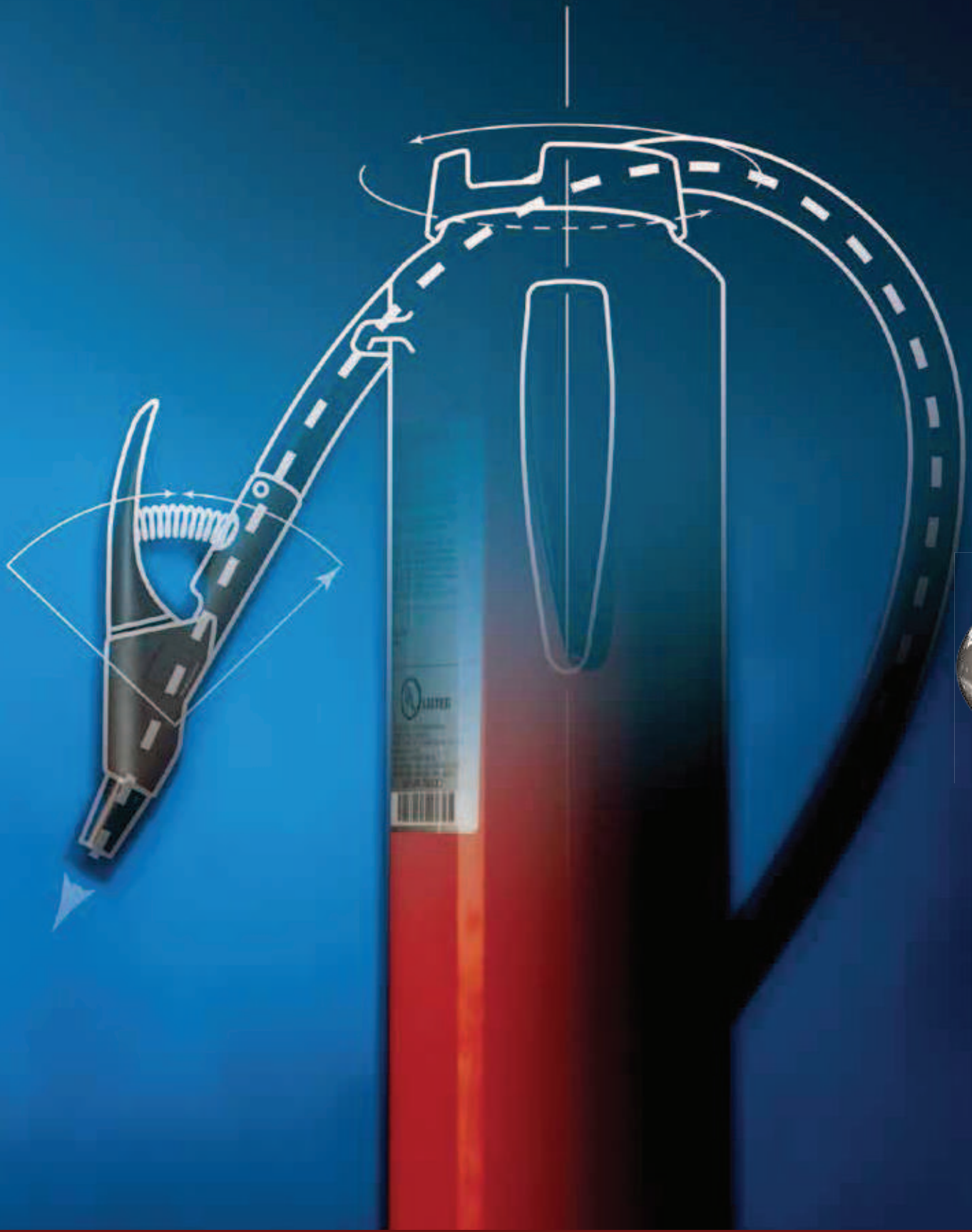

Orders: From origination to delivery—one day or less.

1 FIRE EXTINGUISHERS & CHEMICAL

AMEREX® FIRE EXTINGUISHERS

Ideal for use in offices, warehouses, homes, and more, **Amerex's ABC DRY CHEMICAL FIRE EXTINGUISHERS** use a monoammonium phosphate dry chemical to insulate Class A fires by melting and clinging to the heated surface. They also smother and break the chain reaction on Class B fires and are non-conductors of electricity. Units have a 2½ to 20 lb capacity range. USCG approved with bracket listed on the UL label.

| P/N | SHIP. WEIGHT | UNIT HEIGHT | UNIT WIDTH | SHELL DIAMETER | HEAVY-DUTY BRACKET P/N | FM APPROVED |
|--------|--------------|-------------|------------|----------------|------------------------|-------------|
| AX417T | 5½ lbs | 15½" | 5¾" | 3" | — | Yes |
| AX500 | 9¼ lbs | 15¼" | 7¼" | 4¼" | 5DC | Yes |
| AX500T | 9½ lbs | 15¼" | 7¼" | 4¼" | 5DC | Yes |
| AX424 | 10½ lbs | 15½" | 8" | 4¼" | 5DC | No |
| AX402 | 9¼ lbs | 15¼" | 7¼" | 4¼" | 5DC | No |
| AX402T | 9½ lbs | 15¼" | 7¼" | 4¼" | 5DC | No |
| AX456 | 18 lbs | 20" | 7¾" | 5" | 5HB | No |
| AX441 | 19 lbs | 20½" | 8¾" | 5" | 5HB | No |
| AX411 | 38 lbs | 24" | 10¼" | 7" | 15HB | Yes |
| AX423 | 39 lbs | 24" | 10¼" | 7" | 15HB | Yes |

| P/N | DESCRIPTION | UL RATING |
|--------|------------------------------------|------------|
| AX417T | 2½ lb w/ Vehicle Bracket | 1A:10B:C |
| AX500 | 5 lb w/ Wall Hanger | 2A:10B:C |
| AX500T | 5 lb w/ Vehicle Bracket | 2A:10B:C |
| AX424 | 5 lb w/ Brass Valve & Wall Hanger | 2A:10B:C |
| AX402 | 5 lb w/ Wall Hanger | 3A:40B:C |
| AX402T | 5 lb w/ Vehicle Bracket | 3A:40B:C |
| AX456 | 10 lb w/ Wall Hanger | 4A:80B:C |
| AX441 | 10 lb w/ Brass Valve & Wall Hanger | 4A:80B:C |
| AX411 | 20 lb w/ Wall Hanger | 10A:120B:C |
| AX423 | 20 lb w/ Brass Valve & Wall Hanger | 10A:120B:C |

→ **More ABC DRY CHEMICAL FIRE EXTINGUISHERS Available - Call for Pricing.**

Perfect for kitchens, garages, boats, and vehicles, **Amerex's BC DRY CHEMICAL FIRE EXTINGUISHERS** contain a siliconized sodium bicarbonate based dry chemical, making them suitable for combating flammable liquid and pressurized gas fires. They're also electrically non-conductive, and the chemical, by nature, will not bake to hot surfaces, allowing for easy clean-up. These units are available in a range of sizes from 2½ to 20 lb capacity. USCG approved with bracket listed on the UL label.

| P/N | SHIP. WEIGHT | UNIT HEIGHT | UNIT WIDTH | SHELL DIAMETER | HEAVY-DUTY BRACKET P/N | FM APPROVED |
|--------|--------------|-------------|------------|----------------|------------------------|-------------|
| AX620T | 2½ lbs | 10" | 3½" | 2⅝" | — | No |
| AX403T | 5½ lbs | 15½" | 5¾" | 3" | — | Yes |
| AX453 | 9¾ lbs | 15¼" | 7¼" | 4¼" | 5DC | No |
| AX457 | 18 lbs | 20" | 7¾" | 5" | 5HB | Yes |
| AX412 | 38 lbs | 24" | 10¼" | 7" | 15HB | Yes |

| P/N | DESCRIPTION | UL RATING |
|--------|--------------------------|-----------|
| AX620T | 1 lb w/ Vehicle Bracket | 2B:C |
| AX403T | 2½ lb w/ Vehicle Bracket | 10B:C |
| AX453 | 5½ lb w/ Wall Hanger | 40B:C |
| AX457 | 10 lb w/ Wall Hanger | 60B:C |
| AX412 | 20 lb w/ Wall Hanger | 120B:C |

→ **More BC DRY CHEMICAL FIRE EXTINGUISHERS Available - Call for Pricing.**



AX417T



AX500



AX456



AX411



AX403T



AX453



AX457



AX412



Twice the Flow Rate of Standard Models!

Specially designed for commercial and industrial applications that handle, transport, process, or store large quantities of flammable liquids and gases, these **Amerex HIGH FLOW PORTABLE FIRE EXTINGUISHERS** are the perfect choice. Especially for spills on flat, horizontal surfaces with combustible/non-combustible materials and potential obstacles to fighting a fire. They are made with the same hardware and valve components as **Amerex's** standard models but with twice the flow rate. USCG approved with bracket listed on the UL label.



AX760

AX720

| P/N | SHIP. WEIGHT | UNIT HEIGHT | UNIT WIDTH | SHELL DIAMETER | HEAVY-DUTY BRACKET P/N |
|-------|--------------|----------------------------------|----------------------------------|----------------|------------------------|
| AX720 | 19 lbs | 20 ¹ / ₂ " | 8 ³ / ₄ " | 5" | 5HB |
| AX760 | 39 lbs | 24" | 10 ¹ / ₄ " | 7" | 15HB |
| AX722 | 19 lbs | 20 ¹ / ₂ " | 8 ³ / ₄ " | 5" | 5HB |
| AX762 | 39 lbs | 24" | 10 ¹ / ₄ " | 7" | 15HB |

| P/N | DESCRIPTION | UL RATING | EACH |
|-------|-------------------------------|-----------|------|
| AX720 | 10 lb ABC w/ Wall Hanger | 1A:20B:C | |
| AX760 | 20 lb ABC w/ Wall Hanger | 4A:60B:C | |
| AX722 | 10 lb Purple K w/ Wall Hanger | 20B:C | |
| AX762 | 20 lb Purple K w/ Wall Hanger | 60B:C | |

Amerex's CHROME ABC and BC DRY CHEMICAL FIRE EXTINGUISHERS are chrome-plated steel cylinders with the highest UL ratings per size. A great choice for homes, offices, and autos, as well as recreational and off-road vehicles. USCG approved with bracket listed on the UL label.

| P/N | SHIP. WEIGHT | UNIT HEIGHT | UNIT WIDTH | SHELL DIAMETER | HEAVY-DUTY BRACKET P/N | FM APPROVED |
|---------|-----------------------------------|----------------------------------|---------------------------------|---------------------------------|------------------------|-------------|
| AX620TC | 2 ¹ / ₂ lbs | 10" | 3 ¹ / ₂ " | 2 ³ / ₈ " | — | No |
| AX417TC | 5 ¹ / ₂ lbs | 15 ¹ / ₂ " | 5 ³ / ₄ " | 3" | — | Yes |
| AX500TC | 9 ¹ / ₂ lbs | 15 ¹ / ₄ " | 7 ¹ / ₄ " | 4 ¹ / ₄ " | 5DC | Yes |

| P/N | DESCRIPTION | UL RATING |
|---------|---|-----------|
| AX620TC | 1 lb BC Chrome w/ Vehicle Bracket | 2B:C |
| AX417TC | 2 ¹ / ₂ lb ABC Chrome w/ Vehicle/Marine Bracket | 1A:10B:C |
| AX500TC | 5 lb ABC Chrome w/ Vehicle/Marine Bracket | 2A:10B:C |



AX500TC

Amerex's PURPLE K FIRE EXTINGUISHERS contain specially fluidized and siliconized potassium bicarbonate dry chemical that is most effective on Class B flammable liquids and pressurized gases. Plus they're electrically non-conductive and have long been the choice of oil, gas, chemical, and utilities companies. USCG approved with bracket listed on the UL label.

| P/N | SHIP. WEIGHT | UNIT HEIGHT | UNIT WIDTH | SHELL DIAMETER | HEAVY-DUTY BRACKET P/N | FM APPROVED |
|--------|-----------------------------------|----------------------------------|----------------------------------|---------------------------------|------------------------|-------------|
| AX479T | 9 ¹ / ₂ lbs | 15 ¹ / ₄ " | 7 ¹ / ₄ " | 4 ¹ / ₄ " | 5DC | No |
| AX460 | 19 lbs | 20 ¹ / ₂ " | 8 ³ / ₄ " | 5" | 5HB | Yes |
| AX413 | 38 lbs | 24" | 10 ¹ / ₄ " | 7" | 15HB | Yes |
| AX415 | 39 lbs | 24" | 10 ¹ / ₄ " | 7" | 15HB | Yes |

| P/N | DESCRIPTION | UL RATING |
|--------|--|-----------|
| AX479T | 5 lb Purple K w/ Vehicle Bracket | 30B:C |
| AX460 | 10 lb Purple K w/ Brass Valve & Wall Bracket | 80B:C |
| AX413 | 20 lb Purple K w/ Wall Hanger | 120B:C |
| AX415 | 20 lb Purple K w/ Brass Valve & Wall Hanger | 120B:C |



AX479T



1 FIRE EXTINGUISHERS & CHEMICAL



AX384T



AX385TS



AX386T

An environmentally safe replacement for Halon, **Amerex's HALOTRON I® FIRE EXTINGUISHERS** contain a "clean agent" hydrochlorofluorocarbon discharged as a rapidly evaporating liquid that leaves no residue. Pressurized with argon gas, and EPA approved as an HCFC blend agent, **Halotron I** extinguishes Class A and B fires and will not conduct electricity. Models **AX386T**, **AX397**, and **AX398** are USCG approved with bracket listed on the UL label.

| P/N | SHIP. WEIGHT | UNIT HEIGHT | UNIT WIDTH | SHELL DIAMETER | HEAVY-DUTY BRACKET P/N |
|-------------|------------------------------------|----------------------------------|---------------------------------|---------------------------------|------------------------|
| AX384T | 3 ¹ / ₄ lbs | 10" | 3 ¹ / ₂ " | 2 ⁵ / ₈ " | — |
| AX385TS | 5 ¹ / ₄ lbs | 15 ¹ / ₂ " | 6 ³ / ₈ " | 3" | — |
| DDPAX385TSC | 5 ¹ / ₄ lbs | 15 ¹ / ₂ " | 6 ³ / ₈ " | 3" | — |
| AX386T | 9 ¹ / ₂ lbs | 15 ¹ / ₄ " | 5 ³ / ₄ " | 4 ¹ / ₄ " | 5DC |
| AX397 | 22 ¹ / ₂ lbs | 21 ⁷ / ₈ " | 9 ¹ / ₄ " | 6" | 10HB |
| AX398 | 27 ¹ / ₂ lbs | 21 ⁷ / ₈ " | 9 ¹ / ₄ " | 6" | 10HB |
| DDPAX890 | 57 lbs | 27 ⁷ / ₈ " | 8" | 8" | — |
| DDPAX891 | 115 lbs | 37 ³ / ₈ " | 9" | 9" | — |
| DDPAX892 | 258 lbs | 39 ³ / ₄ " | 14" | 14" | — |

| P/N | DESCRIPTION | UL RATING |
|-------------|---|-----------|
| AX384T | 1.4 lb w/ Vehicle Bracket | 1B:C |
| AX385TS | 2 ¹ / ₂ lb w/ Vehicle Bracket | 2B:C |
| DDPAX385TSC | 2 ¹ / ₂ lb w/ Vehicle Bracket, Chrome | 2B:C |
| AX386T | 5 lb w/ Vehicle Bracket | 5B:C |
| DDPAX386TC | 5 lb Chrome w/ Vehicle Bracket | 5B:C |
| AX397 | 11 lb w/ Wall Hanger | 1A:10B:C |
| AX398 | 15 ¹ / ₂ lb w/ Wall Hanger | 2A:10B:C |
| DDPAX890 | 35 lb Bulk Halotron Cylinder | |
| DDPAX891 | 80 lb Bulk Halotron Cylinder | |
| DDPAX892 | 200 lb Bulk Halotron Cylinder | |

Amerex® HALON 1211 FIRE EXTINGUISHERS feature solid-steel cylinders with all-metal valves and use all-recycled gas in accordance with the Montreal Protocol. **Halon 1211** is a liquefied gas, pressurized with nitrogen, which discharges as a vapor, causing no cold or static shock and no impairment of the operator's vision. This clean agent quickly penetrates difficult-to-see and hard-to-reach areas and leaves no residue. USCG approved with bracket listed on the UL label, except for model **DDPAX344T**.

| P/N | SHIP. WEIGHT | UNIT HEIGHT | UNIT WIDTH | SHELL DIAMETER | HEAVY-DUTY BRACKET P/N |
|-------------|------------------------------------|----------------------------------|---------------------------------|---------------------------------|------------------------|
| DDPAX344T | 1 ¹ / ₄ lbs | 10" | 3 ⁵ / ₈ " | 2 ⁵ / ₈ " | — |
| DDPAX344TC | 2 ³ / ₄ lbs | 10" | 3 ⁵ / ₈ " | 2 ⁵ / ₈ " | — |
| DDPAX352TS | 5 ¹ / ₂ lbs | 14 ³ / ₈ " | 4 ¹ / ₂ " | 3" | — |
| DDPAX352TSC | 5 ¹ / ₂ lbs | 14 ³ / ₈ " | 4 ¹ / ₂ " | 3" | — |
| DDPAX355T | 9 ³ / ₄ lbs | 15 ¹ / ₄ " | 5 ³ / ₄ " | 4 ¹ / ₄ " | 5DC |
| DDPAX369 | 16 ³ / ₄ lbs | 16 ¹ / ₄ " | 8 ¹ / ₂ " | 5" | 5HB |
| DDPAX371 | 22 lbs | 20 ¹ / ₄ " | 8 ¹ / ₂ " | 5" | 5HB |
| DDPAX361 | 36 ¹ / ₄ lbs | 24" | 9 ³ / ₄ " | 7" | 15HB |

| P/N | DESCRIPTION | UL RATING | EACH |
|-------------|--|-----------|------|
| DDPAX344T | 1 ¹ / ₄ lb w/ Vehicle Bracket | 2B:C | |
| DDPAX344TC | 1 ¹ / ₄ lb Chrome w/ Vehicle Bracket | 2B:C | |
| DDPAX352TS | 2 ¹ / ₂ lb w/ Strap Bracket | 5B:C | |
| DDPAX352TSC | 2 ¹ / ₂ lb Chrome w/ Strap Bracket | 5B:C | |
| DDPAX355T | 5 lb w/ Vehicle Bracket | 10B:C | |
| DDPAX369 | 9 lb Brass Valve w/ Wall Hook | 1A:10B:C | |
| DDPAX371 | 13 lb Brass Valve w/ Wall Hook | 2A:40B:C | |
| DDPAX361 | 17 lb Brass Valve w/ Wall Hook | 4A:80B:C | |



AX397



AX398



DDPAX352TS



DDPAX361



Brooks is proud to offer Amerex® HIGH-PERFORMANCE DRY CHEMICAL EXTINGUISHERS. These units feature superior vertical and horizontal range with a high 240 psi operating pressure. Select Fast Flow models offer high flow rates, fast discharge, quicker knockdown, and increased operator protection. Select Compliance Flow models offer longer range and higher UL ratings. Cylinders are made of painted, galvanized drawn steel with protective rubber foot rings and feature all-metal valve construction and gauge guards. Extinguishers come with a standard wall bracket and a 12-year warranty. USCG approved with bracket listed on the UL label.

| P/N | SHIP. WEIGHT | UNIT HEIGHT | UNIT WIDTH | SHELL DIAMETER | HEAVY-DUTY BRACKET P/N |
|----------|--------------|-------------|------------|----------------|------------------------|
| DDPAX594 | 31 lbs | 17 1/2" | 10 1/2" | 7" | 15HB |
| AX581 | 42 1/2 lbs | 24 3/4" | 10 1/2" | 7" | 15HB |
| AX567 | 58 lbs | 26 1/2" | 11" | 8" | 20HB |
| DDPAX592 | 31 lbs | 17 1/2" | 10 1/2" | 7" | 15HB |
| DDPAX564 | 42 1/2 lbs | 24 3/4" | 10 1/2" | 7" | 15HB |
| AX589 | 58 lbs | 26 1/2" | 11" | 8" | 20HB |
| DDPAX582 | 42 1/2 lbs | 24 3/4" | 10 1/2" | 7" | 15HB |
| DDPAX568 | 58 lbs | 26 1/2" | 11" | 8" | 20HB |
| DDPAX595 | 31 lbs | 17 1/2" | 10 1/2" | 7" | 15HB |
| AX580 | 42 1/2 lbs | 24 3/4" | 10 1/2" | 7" | 15HB |
| DDPAX584 | 42 1/2 lbs | 24 3/4" | 10 1/2" | 7" | 15HB |
| AX569 | 58 lbs | 26 1/2" | 11" | 8" | 20HB |
| DDPAX599 | 31 lbs | 17 1/2" | 10 1/2" | 7" | 15HB |
| DDPAX566 | 42 1/2 lbs | 24 3/4" | 10 1/2" | 7" | 15HB |
| AX591 | 58 lbs | 26 1/2" | 11" | 8" | 20HB |

| P/N | DESCRIPTION | UL RATING | EACH |
|----------|----------------------------------|------------|------|
| DDPAX594 | 13.2 lb ABC Fast Flow | 2A:40B:C | |
| AX581 | 20 lb ABC Fast Flow | 4A:40B:C | |
| AX567 | 30 lb ABC Fast Flow | 4A:40B:C | |
| DDPAX592 | 13.2 lb ABC Compliance Flow | 4A:80B:C | |
| DDPAX564 | 20 lb ABC Compliance Flow | 10A:120B:C | |
| AX589 | 30 lb ABC Compliance Flow | 10A:160B:C | |
| DDPAX582 | 20 lb BC Fast Flow | 40B:C | |
| DDPAX568 | 30 lb BC Fast Flow | 40B:C | |
| DDPAX595 | 13.2 lb Purple K Fast Flow | 40B:C | |
| AX580 | 20 lb Purple K Fast Flow | 40B:C | |
| DDPAX584 | 20 lb Purple K Fast Flow | 20B:C | |
| AX569 | 30 lb Purple K Fast Flow | 40B:C | |
| DDPAX599 | 13.2 lb Purple K Compliance Flow | 80B:C | |
| DDPAX566 | 20 lb Purple K Compliance Flow | 120B:C | |
| AX591 | 30 lb Purple K Compliance Flow | 160B:C | |

Amerex's CARBON DIOXIDE (CO₂) PORTABLE FIRE EXTINGUISHERS effectively fight Class B flammable liquid fires and are electrically non-conductive with a clean, non-contaminating, and odorless gas. They are perfectly safe for use on clothing, equipment, valuable documents, and food. FM approved. USCG approved with bracket listed on the UL label.

| P/N | SHIP. WEIGHT | UNIT HEIGHT | UNIT WIDTH | SHELL DIAMETER | HEAVY-DUTY BRACKET P/N |
|-----------|--------------|-------------|------------|----------------|------------------------|
| → AX320 | 8 7/8 lbs | 13 1/4" | 7 1/4" | 14 3/8" | - |
| → AX320NM | 8 7/8 lbs | 13 1/4" | 7 1/4" | 14 3/8" | - |
| AX322 | 14 lbs | 17 3/4" | 8 1/4" | 5 1/4" | 5HB |
| → AX322NM | 14 lbs | 17 3/4" | 8 1/4" | 5 1/4" | - |
| AX330 | 28 1/4 lbs | 24" | 12" | 7" | 15HB |
| AX331 | 37 3/4 lbs | 30" | 12" | 7" | 15HB |
| AX332 | 50 3/4 lbs | 30" | 13" | 8" | 20HB |

| P/N | DESCRIPTION | UL RATING |
|-----------|--------------------------------------|-----------|
| → AX320 | 2 1/2 lb w/ Wall Hanger | 2B:C |
| → AX320NM | 2 1/2 lb Non-Magnetic w/ Wall Hanger | 2B:C |
| AX322 | 5 lb w/ Wall Hanger | 5B:C |
| → AX322NM | 5 lb Non-Magnetic w/ Wall Hanger | 5B:C |
| AX330 | 10 lb w/ Wall Hanger | 10B:C |
| AX331 | 15 lb w/ Wall Hanger | 10B:C |
| AX332 | 20 lb w/ Wall Hanger | 10B:C |



HIGH-PERFORMANCE EXTINGUISHERS



AX322



AX322NM



1 FIRE EXTINGUISHERS & CHEMICAL



RP257

Designed ideally for use on combustible metal fires, **Amerex's CLASS D DRY POWDER FIRE EXTINGUISHERS** are fitted with a "soft-flow" extension applicator to keep operator away from extreme heat and toxic fumes caused by burning material. The applicator can be quickly removed (to provide a straight stream of chemical) when greater range, a narrow discharge pattern, or a lobbing effect is required. Comes with a special corrosion-resistant yellow (Class D) color-coded paint finish. FM approved.

| P/N | SHIP. WEIGHT | UNIT HEIGHT | UNIT WIDTH | SHELL DIAMETER | HEAVY-DUTY BRACKET P/N | EACH |
|----------|--|-------------|------------|----------------|------------------------|--------------|
| AX570 | 53 lbs | 35" | 13" | 8" | 20HB | |
| DDPAX571 | 53 lbs | 35" | 13" | 8" | 20HB | |
| P/N | DESCRIPTION | | | | | EACH |
| AX570 | 30 lb Sodium Chloride w/ Wall Hanger | | | | | |
| DDPAX571 | 30 lb Copper w/ Wall Hanger | | | | | |
| P/N | DESCRIPTION | | | | | |
| RP257 | Class D Sign, "For Use On Combustible Metals Only", 7" x 10" | | | | | SEE PAGE 154 |

Amerex's Class K "Kitchen Use" WET CHEMICAL

EXTINGUISHERS contain a special potassium acetate based low PH agent developed for use with pre-engineered restaurant kitchen systems (included in NFPA 10). Units come fully charged. **DDPAX260CG & DDPAX262CG** are USCG approved with bracket listed on the UL label.

| P/N | SHIP. WEIGHT | UNIT HEIGHT | UNIT WIDTH | SHELL DIAMETER | HEAVY-DUTY BRACKET P/N |
|------------|---|-------------|------------|----------------|------------------------|
| AX260 | 22½ lbs | 19" | 9" | 7" | 15HB |
| DDPAX260CG | 22½ lbs | 19" | 9" | 7" | AX810CG* |
| AX262 | 33½ lbs | 24½" | 9" | 7" | 15HB |
| DDPAX262CG | 33½ lbs | 24½" | 9" | 7" | AX810CG* |
| P/N | DESCRIPTION | | | UL RATING | |
| AX260 | 6lit w/ Wall Hanger | | | 2A:K | |
| DDPAX260CG | 6lit w/ Wall Hanger | | | 2A:K | |
| | Coast Guard Approved w/ AX810CG* | | | | |
| AX262 | 2½ gal w/ Wall Hanger | | | 2A:K | |
| DDPAX262CG | 2½ gal w/ Wall Hanger | | | 2A:K | |
| | Coast Guard Approved w/ AX810CG* | | | | |
| AX5302 | Recharge for AX260, Pkg/2 | | | | |
| AX660 | Recharge for AX262, 2½ gal Wet Chem, Pkg/2 | | | | |
| BL189 | K-Class "Fire Extinguisher" Arrow, 8" x 12" | | | | SEE PAGE 150 |
| AX810CG | Amerex Heavy-Duty Bracket (Galvanized) | | | | SEE PAGE 223 |



BL189

Amerex's STORED PRESSURE WATER

EXTINGUISHER utilizes the cooling, soaking, and penetrating effect of a 45–55 ft stream of water. For use on Class A fires.

Amerex FOAM EXTINGUISHERS are Class A:B extinguishers offering easy, effective application, thanks to their air aspirated nozzles. Ideal for emergency first response vehicles.

| P/N | SHIP. WEIGHT | UNIT HEIGHT | UNIT WIDTH | SHELL DIAMETER | HEAVY-DUTY BRACKET P/N | FM APPROVED |
|-------|--|-------------|------------|----------------|------------------------|-------------|
| AX240 | 7½ lbs | 24½" | 9" | 7" | 15HB | Yes |
| AX250 | 11 lbs | 24½" | 9" | 7" | 15HB | Yes |
| AX252 | 11 lbs | 24½" | 9" | 7" | 15HB | No |
| AX254 | 7½ lbs | 19" | 8" | 7" | 15HB | No |
| P/N | DESCRIPTION | | | UL RATING | | |
| AX240 | 2½ gal Water w/ Wall Hanger | | | 2A | | |
| AX506 | Antifreeze Charge | | | | | |
| AX250 | 2½ gal AFFF Foam w/ Wall Hanger | | | 3A:20B | | |
| AX252 | 2½ gal FFFP w/ Wall Hanger | | | 3A:20B | | |
| 504A | FFFP Premix Charge for 2½ gal Extg., 1.14lit Model 252 | | | | | |
| AX254 | 6lit AFFF w/ Wall Hanger | | | 2A:10B | | |
| 502A | 3% AFFF Premix Charge for 2½ gal & 6lit Extg., 8½ oz Models 250, 254 | | | | | |



AX240



Amerex's AFFF PORTABLE FOAM FIRE EXTINGUISHER

for use on Class A and Class B fires. Features easy and effective application, using the hose and air-aspirating nozzle. FM approved. USCG approved with bracket listed on the UL label.

| P/N | SHIP. WEIGHT | UNIT HEIGHT | UNIT WIDTH | SHELL DIAMETER | HEAVY-DUTY BRACKET P/N | EACH |
|---------|--|-------------|------------|----------------|------------------------|------|
| AX250CG | 11 lbs | 24 1/2" | 9" | 7" | AX810CG | |
| P/N | DESCRIPTION | | | | UL RATING | EACH |
| AX250CG | 2 1/2 gal AFFF USCG Foam Fire Extinguisher | | | | 3A:20B | |
| AX810CG | Bracket for AX250CG | | | | | |

| P/N | DESCRIPTION |
|------|--|
| 502A | 3% AFFF Premix Charge for 2 1/2 gal & 6lit Extg., 8 1/2 oz Models 250, 254 |

Amerex's NON-MAGNETIC STORED PRESSURE DE-IONIZED WATER MIST FIRE EXTINGUISHER

is the ultimate extinguisher for Class A fires where potential Class C (electrical) hazards exist. The fine spray produced from its unique misting nozzle provides protection against electrical shock and greatly enhances the cooling and soaking characteristics of the agent. It also reduces scattering of burning materials. This unit uses de-ionized water, making it the best choice for hospital environments, protecting valuable books and documents, telecommunication facilities, and "clean room" manufacturing facilities. It's easy to use, maintain, and service too. Charge sold separately (extinguisher comes empty).

| P/N | SHIP. WEIGHT | UNIT HEIGHT | UNIT WIDTH | SHELL DIAMETER | HEAVY-DUTY BRACKET P/N | EACH |
|---------|--|-------------|------------|----------------|------------------------|------|
| AX270NM | 7 lbs | 24 1/2" | 11" | 7" | 15HB | |
| AX272NM | 8 lbs | 27 1/2" | 11" | 7" | 15HB | |
| P/N | DESCRIPTION | | | UL RATING | EACH | |
| AX270NM | 1 3/4 gal w/ Wall Hanger | | | 2A:C | | |
| AX272NM | 2 1/2 gal w/ Wall Hanger | | | 2A:C | | |
| AX6702 | 1 3/4 gal De-ionized Water Charge, Pkg/2 | | | | | |
| AX6712 | 2 1/2 gal De-ionized Water Charge, Pkg/2 | | | | | |

Amerex's HEAVY-DUTY DOLLY CART moves larger, heavier extinguishers with ease. Fits cylinders 7"-8" in diameter.

| P/N | DESCRIPTION | EACH |
|------|-----------------------|------|
| 859A | Heavy-Duty Dolly Cart | |

Amerex's REGULATED PRESSURE WHEELED FIRE EXTINGUISHERS

feature a 110 cu. ft. nitrogen cylinder with a pressure regulator and 16" semi-pneumatic rubber tires. Their traditional design allows for adequate pressure to ensure a smooth, complete discharge of the dry chemical with pressure reserve for blowing down the discharge hose. Easy to transport and operate by one person. USCG approved. Call the Sales Department for quantity pricing.

| P/N | SHIP. WEIGHT | UNIT HEIGHT | UNIT WIDTH | UNIT DEPTH | FM APPROVED | EACH |
|----------|-------------------------------|-------------|------------|------------|-------------|------|
| DDPAX467 | 404 lbs | 52" | 26" | 38" | No | |
| DDPAX469 | 404 lbs | 52" | 26" | 38" | Yes | |
| DDPAX468 | 429 lbs | 52" | 26" | 38" | No | |
| P/N | DESCRIPTION | | | UL RATING | EACH | |
| DDPAX467 | 125 lb Regulated Pressure ABC | | | 30A:240B:C | | |
| DDPAX469 | 125 lb Regulated Pressure PK | | | 320B:C | | |
| DDPAX468 | 150 lb Regulated Pressure BC | | | 240B:C | | |



AX250CG



AX272NM



859A



DDPAX467



1 FIRE EXTINGUISHERS & CHEMICAL



Amerex's REGULATED PRESSURE WHEELED FIRE EXTINGUISHERS feature a 110 cu. ft. nitrogen cylinder with a pressure regulator and 2 1/2" x 36" steel wheels. This traditional design allows for adequate pressure to ensure a smooth, complete discharge of the dry chemical with pressure reserve for blowing down the discharge hose. Easy to transport and operate by one person. USCG approved. Call the Sales Department for quantity pricing.

| P/N | SHIP. WEIGHT | UNIT HEIGHT | UNIT WIDTH | UNIT DEPTH | FM APPROVED |
|----------|--------------|-------------|------------|------------|-------------|
| DDPAX470 | 432 lbs | 52" | 28" | 45" | No |
| DDPAX472 | 432 lbs | 52" | 28" | 45" | Yes |
| DDPAX471 | 457 lbs | 52" | 28" | 45" | No |

| P/N | DESCRIPTION | UL RATING | EACH |
|----------|-------------------------------|------------|------|
| DDPAX470 | 125 lb Regulated Pressure ABC | 30A:240B:C | |
| DDPAX472 | 125 lb Regulated Pressure PK | 320B:C | |
| DDPAX471 | 150 lb Regulated Pressure BC | 240B:C | |

DDPAX470



Amerex's DIRECT PRESSURE WHEELED FIRE EXTINGUISHERS utilize a 23 cu. ft. nitrogen cylinder on 125 lb and 150 lb units, and a 55-cubic-ft nitrogen cylinder on 300 lb and 350 lb units with a "quick opening valve" to pressurize and completely discharge the agent cylinder. The 125 lb and 150 lb units have 16" semi-pneumatic tires. The 300 lb and 350 lb units have 6" x 36" steel wheels. Both allow for easy maneuvering and operation by one person. All units fitted with a 4" stainless steel fill opening and brass cap for easy servicing. USCG approved. Call the Sales Department for quantity pricing.

| P/N | SHIP. WEIGHT | UNIT HEIGHT | UNIT WIDTH | UNIT DEPTH | FM APPROVED |
|----------|--------------|-------------|------------|------------|-------------|
| AX450 | 335 lbs | 45" | 24" | 36" | No |
| DDPAX451 | 360 lbs | 45" | 24" | 36" | No |
| AX452 | 335 lbs | 45" | 24" | 36" | Yes |
| DDPAX491 | 743 lbs | 57" | 34" | 39" | No |
| DDPAX492 | 793 lbs | 57" | 34" | 39" | No |
| AX493 | 743 lbs | 57" | 34" | 39" | Yes |

| P/N | DESCRIPTION | UL RATING | EACH |
|----------|----------------------------|------------|------|
| AX450 | 125 lb Direct Pressure ABC | 30A:240B:C | |
| DDPAX451 | 150 lb Direct Pressure BC | 240B:C | |
| AX452 | 125 lb Direct Pressure PK | 320B:C | |
| DDPAX491 | 300 lb Direct Pressure ABC | 40A:320B:C | |
| DDPAX492 | 350 lb Direct Pressure BC | 320B:C | |
| AX493 | 300 lb Direct Pressure PK | 320B:C | |

AX450



DDPAX491



Amerex's STORED PRESSURE WHEELED FIRE EXTINGUISHERS feature cage-type protection for the agent cylinder and a balanced platform for transportation and operation. The narrow width and semi-pneumatic rubber tires allow for one-person operation in confined areas. Chemical and pressure are sealed in the agent cylinder. USCG approved. Call the Sales Department for quantity pricing.

| P/N | SHIP. WEIGHT | UNIT HEIGHT | UNIT WIDTH | UNIT DEPTH | |
|----------|--------------|-------------|------------|------------|--|
| AX495 | 174 lbs | 46" | 21 1/2" | 24" | |
| DDPAX496 | 174 lbs | 46" | 21 1/2" | 24" | |
| DDPAX497 | 174 lbs | 46" | 21 1/2" | 24" | |
| AX488 | 344 lbs | 53 1/2" | 28" | 40" | |
| DDPAX490 | 344 lbs | 53 1/2" | 28" | 40" | |
| DDPAX489 | 369 lbs | 53 1/2" | 28" | 40" | |

| P/N | DESCRIPTION | UL RATING | EACH |
|----------|----------------------------|------------|------|
| AX495 | 50 lb Stored Pressure ABC | 20A:160B:C | |
| DDPAX496 | 50 lb Stored Pressure BC | 160B:C | |
| DDPAX497 | 50 lb Stored Pressure PK | 160B:C | |
| AX488 | 125 lb Stored Pressure ABC | 30A:240B:C | |
| DDPAX490 | 125 lb Stored Pressure PK | 320B:C | |
| DDPAX489 | 150 lb Stored Pressure BC | 240B:C | |

→ **More STORED PRESSURE WHEELED FIRE EXTINGUISHERS Available - Call for Pricing.**

Amerex's WHEELED HALOTRON I™ FIRE EXTINGUISHERS feature the same qualities found in all Amerex products and add the convenience of a clean extinguishing agent with a low GWP (Global Warming Potential) and a low ODP (Ozone Depletion Potential). **Halotron I** has a short atmospheric lifetime, and each unit maximizes agent visibility during discharge. There's no thermal shock, static shock, or electrical conductivity back to the operator. EPA approved for Class A, B, and C hazards, as well as FAA approved for both ramp use (ARFF vehicle) and on-board an aircraft. Call the Sales Department for quantity pricing.

| P/N | SHIP. WEIGHT | UNIT HEIGHT | UNIT WIDTH | UNIT DEPTH | |
|----------|--------------|-------------|------------|------------|--|
| DDPAX673 | 286 lbs | 58" | 28" | 39" | |
| DDPAX674 | 512 lbs | 64" | 30" | 42" | |
| DDPAX675 | 610 lbs | 64" | 37" | 43" | |

| P/N | DESCRIPTION | UL RATING | EACH |
|----------|-----------------------------------|-----------|------|
| DDPAX673 | 65 lb Halotron I | 4A:60B:C | |
| DDPAX674 | 150 lb Halotron I | 10A:80B:C | |
| DDPAX675 | 150 lb Halotron I w/ Steel Wheels | 10A:80B:C | |



1 FIRE EXTINGUISHERS & CHEMICAL



Amerex's FFFP WHEELED FIRE EXTINGUISHER

contains a premixed **FFFP** (Film Forming Fluoroprotein) alcohol-resistant foam. **FFFP** is highly effective on Class B fuel fires and a penetrating/wetting agent on fires involving Class A materials. Unit features quality hardware throughout, including a unique agent cylinder fabricated entirely of stainless steel—no interior coatings are necessary. Meets NFPA requirements for hospital helicopter pad protection. USCG approved. Call the Sales Department for quantity pricing.

| P/N | SHIP. WEIGHT | UNIT HEIGHT | UNIT WIDTH | UNIT DEPTH |
|----------|--------------|-------------|------------|------------|
| DDPAX630 | 390 lbs | 57" | 34" | 39" |

| P/N | DESCRIPTION | UL RATING | EACH |
|----------|--------------------------------|-----------|------|
| DDPAX630 | 33 gal Direct Pressure FFFP | 20A:160B | |
| DDPAX534 | Recharge for Model 630, 2½ gal | | |

DDPAX630



Amerex's CLASS D WHEELED FIRE EXTINGUISHERS

are ideal for large combustible metal fires. They're well balanced for quick transport, thanks to 36" non-sparking rubber-treaded steel wheels. Both extinguishers are pressurized with argon and regulated to a low 125 psi (to avoid disrupting the burning materials). FM approved. Call the Sales Department for quantity pricing.

| P/N | SHIP. WEIGHT | UNIT HEIGHT | UNIT WIDTH | UNIT DEPTH |
|----------|--------------|-------------|------------|------------|
| DDPAX680 | 444 lbs | 52" | 28" | 45" |
| DDPAX681 | 544 lbs | 52" | 28" | 45" |

| P/N | DESCRIPTION | EACH |
|----------|---|------|
| DDPAX680 | 150 lb Regulated Pressure Sodium Chloride | |
| DDPAX681 | 250 lb Regulated Pressure Copper Powder | |

DDPAX681



Amerex's CARBON DIOXIDE (CO₂) WHEELED FIRE EXTINGUISHERS

are easy to operate with a "quick opening" T-handle valve and horn-mounted shut-off valve. A logical choice where a Class B:C non-contaminating agent is required and hand portable protection or the number of personnel would not be adequate. USCG approved. Call the Sales Department for quantity pricing.

| P/N | SHIP. WEIGHT | UNIT HEIGHT | UNIT WIDTH | UNIT DEPTH |
|-------|--------------|-------------|------------|------------|
| AX333 | 257 lbs | 47" | 23" | 48" |
| AX334 | 461 lbs | 47" | 23" | 48" |

| P/N | DESCRIPTION | UL RATING | EACH |
|-------|------------------------|-----------|------|
| AX333 | 50 lb CO ₂ | 20B:C | |
| AX334 | 100 lb CO ₂ | 20B:C | |

AX333

NOTE: All prices quoted are FOB factory unless shipped from stock. All nitrogen cylinder operated wheeled extinguishers are shipped with the "DRY CHEMICAL" agent in pails. Most wheeled units are available in a stationary configuration. Inquire about special quantity pricing.



Square Threaded Valves Install/Remove Fast!

Badger™ ADVANTAGE MULTI-PURPOSE EXTINGUISHERS are made to handle easier and be recharged quicker, thanks to a larger neck opening. The square thread design allows the valve to be removed and installed quickly. Heavy-duty plated steel siphon tubes are threaded for a more secure connection, and the polymer hose strap won't scratch the cylinder. Larger pull pin and handles are easy to operate—even with work gloves. Depending on the extinguisher size and fire type, **Advantage Fire Extinguishers** can be used in vehicles, homes, schools, offices, and more.

| P/N | SHIP. WEIGHT | UNIT HEIGHT | UNIT WIDTH | SHELL DIAMETER | HEAVY-DUTY BRACKET P/N |
|-----------|--------------|-------------|------------|----------------|------------------------|
| 21007865B | 5 lbs | 15" | 5 1/2" | 3 1/4" | - |
| 21007866B | 9 1/2 lbs | 16 7/16" | 7 1/2" | 4 1/2" | 5DC |
| 21008936B | 9 1/2 lbs | 16 7/16" | 7 1/2" | 4 1/2" | 5DC |
| 21007867B | 17 1/2 lbs | 19 3/8" | 8" | 5 3/16" | 5HB |
| 21007868B | 31 1/2 lbs | 21 3/4" | 9" | 7 1/8" | - |

| P/N | DESCRIPTION | UL RATING |
|-----------|---------------------------------------|-----------|
| 21007865B | 2 1/2 lb Advantage w/ Vehicle Bracket | 1A:10B:C |
| 21007866B | 5 lb Advantage w/ Wall Hook | 3A:40B:C |
| 21008936B | 5 lb Advantage w/ Vehicle Bracket | 3A:40B:C |
| 21007867B | 10 lb Advantage w/ Wall Hook | 4A:60B:C |
| 21007868B | 20 lb Advantage w/ Wall Hook | 6A:80B:C |



21007865B

BADGER FIRE EXTINGUISHERS

Badger's STORED PRESSURE MULTI-PURPOSE FIRE EXTINGUISHERS are extremely versatile. They will tackle the majority of fire risks found in most commercial, industrial, and domestic environments. They are suitable for use on Class A, B, and C fires and mount on any surface with the wall hook supplied, or, if preferred, they can be supplied with optional vehicle bracket. USCG approved with bracket listed on the UL label.

| P/N | SHIP. WEIGHT | UNIT HEIGHT | UNIT WIDTH | SHELL DIAMETER | HEAVY-DUTY BRACKET P/N |
|--------|--------------|-------------|------------|----------------|------------------------|
| 22430B | 5 3/8 lbs | 14 7/8" | 5 1/2" | 3" | - |
| 23384B | 5 1/2 lbs | 14 7/8" | 5 1/2" | 3" | - |
| 22435B | 10 lbs | 15 1/4" | 7 1/4" | 4 1/4" | 5DC |
| 22486B | 10 lbs | 15 1/4" | 7 1/4" | 4 1/4" | 5DC |
| 23390B | 10 3/8 lbs | 15 1/4" | 7 1/4" | 4 1/4" | 5DC |
| 22603B | 17 lbs | 18 15/16" | 7 3/4" | 5 1/4" | 5HB |
| 23396B | 18 lbs | 18 15/16" | 7 3/4" | 5 1/4" | 5HB |
| 22682B | 33 lbs | 21 1/8" | 9 1/4" | 7 1/4" | 15HBL |
| 23497B | 33 lbs | 21 1/8" | 9 1/4" | 7 1/4" | 15HBL |

| P/N | DESCRIPTION | UL RATING |
|--------|---|-----------|
| 22430B | 2 1/2 lb w/ Vehicle Bracket | 1A:10B:C |
| 23384B | 2 1/2 lb Brass Valve w/ Vehicle Bracket | 1A:10B:C |
| 22435B | 5 lb w/ Wall Hook | 3A:40B:C |
| 22486B | 5 lb w/ Vehicle Bracket | 3A:40B:C |
| 23390B | 5 lb Brass Valve w/ Wall Hook | 3A:40B:C |
| 22603B | 10 lb w/ Wall Hook | 4A:80B:C |
| 23396B | 10 lb Brass Valve w/ Wall Hook | 4A:80B:C |
| 22682B | 20 lb w/ Wall Hook | 6A:120B:C |
| 23497B | 20 lb Brass Valve w/ Wall Hook | 6A:120B:C |



22430B



22682B



1 FIRE EXTINGUISHERS & CHEMICAL



23476B

Badger's REGULAR DRY CHEMICAL STORED PRESSURE FIRE EXTINGUISHERS

are specifically designed to meet the needs of industrial and commercial premises where there is a flammable liquid risk. They are cost effective to maintain and offer good value and excellent performance. Suitable for use on Class B and C fires and mount on any surface with wall hook, forked hanger, or an optional vehicle bracket. USCG approved with bracket listed on the UL label.

| P/N | SHIP. WEIGHT | UNIT HEIGHT | UNIT WIDTH | SHELL DIAMETER | HEAVY-DUTY BRACKET P/N |
|--------|------------------------------------|----------------------------------|---------------------------------|---------------------------------|------------------------|
| 23471B | 5 ³ / ₈ lbs | 14 ⁷ / ₈ " | 5 ¹ / ₂ " | 3" | - |
| 23476B | 10 ¹ / ₂ lbs | 15 ¹ / ₄ " | 7 ¹ / ₄ " | 4 ¹ / ₄ " | 5DC |
| 23781B | 18 lbs | 19 ¹ / ₈ " | 8 ¹ / ₈ " | 5 ¹ / ₄ " | 5HB |
| 23482B | 33 lbs | 21 ¹ / ₈ " | 9 ¹ / ₄ " | 7 ¹ / ₄ " | 15HBL |

| P/N | DESCRIPTION | UL RATING |
|--------|---|-----------|
| 23471B | 2 ³ / ₄ lb Brass Valve w/ Vehicle Bracket | 10B:C |
| 23476B | 5 lb Brass Valve w/ Wall Hook | 40B:C |
| 23781B | 10 lb Brass Valve w/ Wall Hook | 60B:C |
| 23482B | 20 lb Brass Valve w/ Wall Hook | 120B:C |



23488B



23778B

Badger's PURPLE K DRY CHEMICAL STORED PRESSURE FIRE EXTINGUISHERS

are designed for use on high hazard types of Class B and C fires. Purple K is generally superior to other dry chemicals on Class B fires, making these extinguishers ideal for use in industrial and commercial premises where a flammable liquid or gas fire risks exist. USCG approved with bracket listed on the UL label.

| P/N | SHIP. WEIGHT | UNIT HEIGHT | UNIT WIDTH | SHELL DIAMETER | HEAVY-DUTY BRACKET P/N |
|--------|------------------------------------|------------------------------------|---------------------------------|---------------------------------|------------------------|
| 23485B | 5 ⁷ / ₈ lbs | 14 ⁷ / ₈ " | 5 ¹ / ₂ " | 3" | - |
| 23488B | 10 ³ / ₈ lbs | 15 ¹ / ₄ " | 7 ¹ / ₄ " | 4 ¹ / ₄ " | 5DC |
| 23778B | 17 lbs | 18 ¹⁵ / ₁₆ " | 7 ³ / ₄ " | 5 ¹ / ₄ " | 5HB |
| 23495B | 32 lbs | 21 ¹ / ₈ " | 9 ¹ / ₄ " | 7 ¹ / ₄ " | 15HBL |

| P/N | DESCRIPTION | UL RATING | EACH |
|--------|---|-----------|------|
| 23485B | 2 ¹ / ₂ lb Brass Valve w/ Vehicle Bracket | 10B:C | |
| 23488B | 5 lb Brass Valve w/ Wall Hook | 30B:C | |
| 23778B | 10 lb Brass Valve w/ Wall Hook | 80B:C | |
| 23495B | 20 lb Brass Valve w/ Wall Hook | 120B:C | |

Badger™ EXTRA HIGH FLOW DRY CHEMICAL

EXTINGUISHERS feature a steel cylinder, internal siphon tube, and heavy-duty chrome-plated brass valves. These models, available in ABC and Purple K, have dry chemical agent discharge rates exceeding the minimum one-pound-per-second recommendation of NFPA for pressure, three dimensional, and obstacle fires. The ultimate protection against Class B hazards. USCG approved with bracket listed on the UL label.

| P/N | SHIP. WEIGHT | UNIT HEIGHT | UNIT WIDTH | SHELL DIAMETER | HEAVY-DUTY BRACKET P/N |
|-----------|--------------|----------------------------------|---------------------------------|---------------------------------|------------------------|
| 21006158B | 18 lbs | 19 ¹ / ₈ " | 8 ¹ / ₈ " | 5 ¹ / ₄ " | 5HB |
| 21006160B | 33 lbs | 21 ¹ / ₈ " | 9 ¹ / ₄ " | 7 ¹ / ₄ " | 15HBL |
| 21006159B | 18 lbs | 19 ¹ / ₈ " | 8 ¹ / ₈ " | 5 ¹ / ₄ " | 5HB |
| 21006161B | 33 lbs | 21 ¹ / ₈ " | 9 ¹ / ₄ " | 7 ¹ / ₄ " | 15HBL |

| P/N | DESCRIPTION | UL RATING | EACH |
|-----------|---------------------------------------|-----------|------|
| 21006158B | 10 lb ABC High Flow w/ Wall Hook | 1A:20B:C | |
| 21006160B | 20 lb ABC High Flow w/ Wall Hook | 4A:60B:C | |
| 21006159B | 10 lb Purple K High Flow w/ Wall Hook | 20B:C | |
| 21006161B | 20 lb Purple K High Flow w/ Wall Hook | 60B:C | |



21006158B



Badger's HALOTRON I™ FIRE EXTINGUISHERS are an environmentally acceptable Halon alternative and designed to meet any special hazard where **Halon 1211** was specified and used. **Halotron I** is ideal for protecting office computer areas, data storage, telecommunications, and high-tech clean rooms. **Halotron I** is the government specified clean agent alternative and is USCG approved with bracket listed on the UL label, except for model **24563B**.

| P/N | SHIP. WEIGHT | UNIT HEIGHT | UNIT WIDTH | SHELL DIAMETER | HEAVY-DUTY BRACKET P/N |
|--------|------------------------------------|-----------------------------------|---------------------------------|---------------------------------|------------------------|
| 24563B | 6 ⁷ / ₈ lbs | 14 ⁷ / ₈ " | 6 ¹ / ₈ " | 3" | - |
| 24567B | 10 ³ / ₈ lbs | 15 ¹ / ₄ " | 6 ¹ / ₈ " | 4 ¹ / ₄ " | 5DC |
| 23082B | 23 lbs | 16 ³ / ₁₆ " | 8 ¹ / ₃ " | 7 ¹ / ₄ " | 15HBL |
| 23097B | 26 ¹ / ₂ lbs | 17 ¹ / ₈ " | 8 ³ / ₄ " | 7 ¹ / ₄ " | 15HBL |

| P/N | DESCRIPTION | UL RATING |
|--------|--|-----------|
| 24563B | 2 ¹ / ₂ lb Halotron I w/ Vehicle Bracket | 2B:C |
| 24567B | 5 lb Halotron I w/ Wall Hook | 5B:C |
| 23082B | 11 lb Halotron I w/ Wall Hook | 1A:10B:C |
| 23097B | 15 ¹ / ₂ lb Halotron I w/ Wall Hook | 2A:10B:C |



24563B



23082B

Badger's CARBON DIOXIDE (CO₂) FIRE EXTINGUISHERS give fast, safe, and effective protection against fires involving electrical equipment and flammable liquids. They are generally suited for use indoors, making them ideal for today's office environments. The cylinders are manufactured from lightweight high-grade aluminum. They are highly effective, easy to use, and leave no messy residue to clean up. USCG approved with bracket listed on the UL label, except for **25078B**.

| P/N | SHIP. WEIGHT | UNIT HEIGHT | UNIT WIDTH | SHELL DIAMETER | HEAVY-DUTY BRACKET P/N |
|--------|--------------|-----------------------------------|----------------------------------|---------------------------------|------------------------|
| 21111B | 15 lbs | 17" | 8 ¹ / ₂ " | 5 ¹ / ₄ " | 5HB |
| 21106B | 30 lbs | 19 ⁵ / ₁₆ " | 10 ⁷ / ₈ " | 6 ⁷ / ₈ " | 15HB |
| 21103B | 40 lbs | 26" | 10 ⁷ / ₈ " | 6 ⁷ / ₈ " | 15HB |
| 21096B | 51 lbs | 26" | 12" | 8" | 20HB |
| 25078B | 15 lbs | 17" | 8 ¹ / ₂ " | 5 ¹ / ₄ " | 5HB |

| P/N | DESCRIPTION | UL RATING |
|--------|------------------------------------|-----------|
| 21111B | 5 lb Carbon Dioxide | 5B:C |
| 21106B | 10 lb Carbon Dioxide | 10B:C |
| 21103B | 15 lb Carbon Dioxide | 10B:C |
| 21096B | 20 lb Carbon Dioxide | 10B:C |
| 25078B | 5 lb Carbon Dioxide (Non-Magnetic) | 5B:C |



21111B



25078B

Badger's UNIVERSAL ULTRA FOAM EXTINGUISHERS are effective on Class A common combustibles as well as both hydrocarbon and polar solvent types of Class B flammable liquids, so they eliminate the application guesswork associated with other foams. The unique synthetic base of **Universal Ultra Foam** does not have any offensive odors, is non-toxic, environmentally friendly, biodegradable, and extremely simple to use and clean up.

| P/N | SHIP. WEIGHT | UNIT HEIGHT | UNIT WIDTH | SHELL DIAMETER | HEAVY-DUTY BRACKET P/N |
|--------|--------------|----------------------------------|---------------------------------|----------------|------------------------|
| 23697B | 12 lbs | 24 ¹ / ₂ " | 8 ³ / ₄ " | 7" | 15HB |

| P/N | DESCRIPTION | UL RATING |
|--------|--|-----------|
| 23697B | 2 ¹ / ₂ gal Foam | 1A:30B |
| 23691B | 6lit Recharge | |
| 23702B | 2 ¹ / ₂ gal Recharge | |



23697B



1 FIRE EXTINGUISHERS & CHEMICAL



25064B

The firefighting power and user-friendly design of **Badger's WET CHEMICAL PORTABLE EXTINGUISHER** makes it the ideal choice for commercial restaurant applications. This stored pressure extinguisher has been designed to offer the very best portable fire protection available in supplementing pre-engineered restaurant suppression systems. Units come fully charged.

| P/N | SHIP. WEIGHT | UNIT HEIGHT | UNIT WIDTH | SHELL DIAMETER | HEAVY-DUTY BRACKET P/N |
|--------|--------------------------|----------------------------------|---------------------------------|----------------|------------------------|
| 25064B | 15 lbs | 19 ¹ / ₂ " | 8 ³ / ₄ " | 7" | 15HB |
| P/N | DESCRIPTION | UL RATING | | | |
| 25064B | 6lit Wet Chemical | K | | | |
| AC100 | 6lit Recharge Jug, Pkg/2 | | | | |

Badger's STORED PRESSURE WATER

EXTINGUISHER is ideal for common combustible materials, such as trash, wood, and paper. **Badger's** non-toxic, ozone-friendly, pressurized water fire extinguisher performs better, lasts longer, and is the number one choice for virtually all Class A-type hazards.

| P/N | SHIP. WEIGHT | UNIT HEIGHT | UNIT WIDTH | SHELL DIAMETER | HEAVY-DUTY BRACKET P/N |
|--------|---|----------------------------------|---------------------------------|----------------|------------------------|
| 16888B | 8 lbs | 24 ³ / ₄ " | 8 ³ / ₄ " | 7" | 15HB |
| P/N | DESCRIPTION | UL RATING | | | |
| 16888B | 2 ¹ / ₂ gal Water | 2A | | | |
| 792B | WP-61 Antifreeze Charge | | | | |



DDP466521B



16888B

Badger™ BRIGADE CARBON DIOXIDE (CO₂)

CARTRIDGE OPERATED UNITS are the industry's most effective fire extinguisher of their kind. Available in ABC, BC, or PK, these units use carbon dioxide expellent gas and feature deep-drawn seamless steel construction (with corrosion-resistant cylinders) for maximum performance. USCG approved with bracket listed on the UL label. For use down to -40°F.

| P/N | SHIP WEIGHT | UNIT HEIGHT | UNIT WIDTH | SHELL DIAMETER | HEAVY DUTY BRACKET P/N |
|------------|------------------------------------|----------------------------------|----------------------------------|----------------------------------|------------------------|
| DDP466521B | 25 ¹ / ₂ lbs | 18 ¹ / ₄ " | 9 ¹ / ₂ " | 5 ¹ / ₁₀ " | 466541B |
| DDP466523B | 25 ¹ / ₂ lbs | 18 ¹ / ₄ " | 9 ¹ / ₂ " | 5 ¹ / ₁₀ " | 466541B |
| 466527B | 45 ¹ / ₂ lbs | 23 ³ / ₈ " | 11 ¹ / ₄ " | 6 ¹ / ₄ " | 466542B |
| DDP466564B | 45 ¹ / ₂ lbs | 23 ³ / ₈ " | 11 ¹ / ₄ " | 6 ¹ / ₄ " | 466542B |
| 466528B | 47 ¹ / ₂ lbs | 23 ³ / ₈ " | 11 ¹ / ₄ " | 6 ¹ / ₄ " | 466542B |
| 466529B | 46 ¹ / ₂ lbs | 23 ³ / ₈ " | 11 ¹ / ₄ " | 6 ¹ / ₄ " | 466542B |
| 466533B | 51 lbs | 23 ³ / ₈ " | 12 ¹ / ₄ " | 7 ¹ / ₅ " | 466543B |
| 466539B | 55 lbs | 23 ³ / ₈ " | 12 ¹ / ₄ " | 7 ¹ / ₅ " | 466543B |
| 466534B | 54 ¹ / ₂ lbs | 23 ³ / ₈ " | 12 ¹ / ₄ " | 7 ¹ / ₅ " | 466543B |

| P/N | DESCRIPTION | UL RATING | EACH |
|------------|---------------------|-----------|------|
| DDP466521B | 10 lb ABC | 4A:40B:C | |
| DDP466523B | 10 lb Purple K | 60B:C | |
| 466527B | 20 lb ABC | 10A:60B:C | |
| DDP466564B | 20 lb ABC High Flow | 2A:40B:C | |
| 466528B | 20 lb BC | 60B:C | |
| 466529B | 20 lb Purple K | 80B:C | |
| 466533B | 30 lb ABC | 10A:80BC | |
| 466539B | 30 lb BC | 120B:C | |
| 466534B | 30 lb Purple K | 120B:C | |



466527B



466533B



When high-hazard fires demand a fast one-person response and exceptional performance, **Badger's WHEELED STORED PRESSURE DRY CHEMICAL EXTINGUISHERS** give you the power you need. Long-range discharge gives control over ordinarily out-of-reach fires and allows the operator to keep a safe distance from the fire source and smoke. The 50 lb unit provides cost effective, reliable fire protection, while the 125 lb models are USCG approved.

| P/N | SHIP. WEIGHT | UNIT HEIGHT | UNIT WIDTH | UNIT DEPTH |
|-----------|--------------|----------------------------------|------------|----------------------------------|
| 20127B | 140 lbs | 46 ¹ / ₄ " | 23" | 23" |
| 20180B | 140 lbs | 46 ¹ / ₄ " | 23" | 23" |
| 20653B | 300 lbs | 58" | 28" | 39 ¹ / ₄ " |
| 20684B | 300 lbs | 58" | 28" | 39 ¹ / ₄ " |
| DDP20677B | 375 lbs | 58" | 28" | 39 ¹ / ₄ " |

| P/N | DESCRIPTION | UL RATING | EACH |
|-----------|-----------------|------------|------|
| 20127B | 50 lb ABC | 20A:160B:C | |
| 20180B | 50 lb Purple K | 160B:C | |
| 20653B | 125 lb ABC | 40A:240B:C | |
| 20684B | 125 lb Purple K | 240B:C | |
| DDP20677B | 150 lb BC | 240B:C | |



Badger's WHEELED REGULATED RELEASE and DIRECT RELEASE DRY CHEMICAL EXTINGUISHERS are recommended for chemical or petroleum plants, storage facilities, airports, warehouses, construction sites, equipment depots, and other high-hazard locations where dry chemical is the preferred agent. Highly mobile, these units permit a single operator to extinguish fires that would normally require several operators with large portables.

| P/N | SHIP. WEIGHT | UNIT HEIGHT | UNIT WIDTH | UNIT DEPTH | TYPE |
|-----------|--------------|-------------|------------|------------|--------------------|
| DDP19900B | 435 lbs | 52" | 27" | 39" | Regulated Pressure |
| DDP19906B | 440 lbs | 52" | 27" | 39" | Regulated Pressure |
| DDP19915B | 415 lbs | 52" | 27" | 45" | Regulated Pressure |

| P/N | DESCRIPTION | UL RATING | EACH |
|-----------|-----------------|------------|------|
| DDP19900B | 145 lb ABC | 40A:240B:C | |
| DDP19906B | 150 lb BC | 240B:C | |
| DDP19915B | 125 lb Purple K | 240B:C | |



Badger's WHEELED CARBON DIOXIDE (CO₂) EXTINGUISHERS provide excellent protection for certain flammable liquids and energized electrical equipment. They can be operated by a single person, and the squeeze-grip control valve design allows for easy use. They are generally reserved for indoor use where wind and drafts will not disperse a discharge pattern. Carbon dioxide is a clean agent and leaves no residue.

| P/N | SHIP. WEIGHT | UNIT HEIGHT | UNIT WIDTH | UNIT DEPTH |
|-----------|--------------|-------------|----------------------------------|------------|
| DDP22724B | 271 lbs | 52" | 21 ¹ / ₂ " | 33" |
| DDP22725B | 446 lbs | 52" | 32" | 33" |

| P/N | DESCRIPTION | UL RATING | EACH |
|-----------|-----------------------|-----------|------|
| DDP22724B | 50 lb Carbon Dioxide | 20B:C | |
| DDP22725B | 100 lb Carbon Dioxide | 20B:C | |



FIREBOY FIRE EXTINGUISHERS

Fireboy® HR-227 CLEAN AGENT FIRE EXTINGUISHER SYSTEMS

are the cleaner, safer, and more effective alternative to dry chemical portable fire extinguishers. They leave no residue or powdery mess behind and have a quicker fire-out time. When 175°F (79°C) is reached, the extinguisher will automatically discharge, releasing the clean agent gas to totally flood the entire space, smothering the fire. For occupied and unoccupied areas and most all marine applications. Approved for Class B fires.

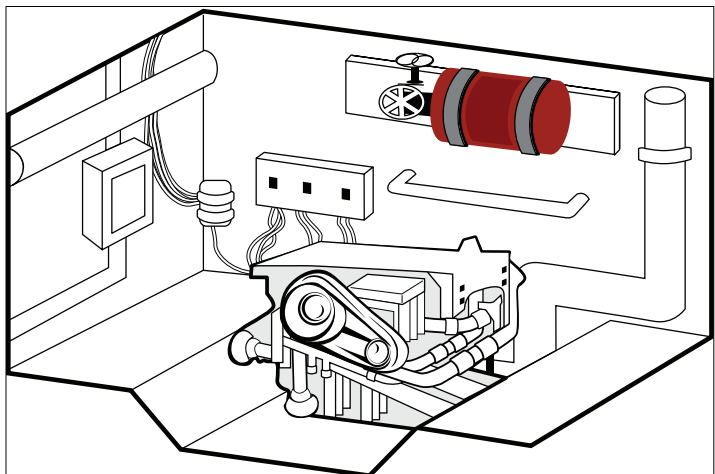

MOUNTED INSTALLATION



DDP25HFC227



DDP500HFC227

| P/N | DESCRIPTION | MAXIMUM VOLUME PROTECTED | SHELL DIAMETER | UNIT HEIGHT | GROSS WEIGHT | EACH |
|---------------|-------------|--------------------------|----------------|-------------|--------------|------|
| DDP25HFC227 | HFC-227 | 25 cu. ft. | 3.0" | 9.1" | 6 lbs | |
| DDP50HFC227 | HFC-227 | 50 cu. ft. | 3.0" | 12.2" | 8 lbs | |
| DDP75HFC227 | HFC-227 | 75 cu. ft. | 4.3" | 11.9" | 9 lbs | |
| DDP100HFC227 | HFC-227 | 100 cu. ft. | 4.3" | 14.5" | 13 lbs | |
| DDP125HFC227 | HFC-227 | 125 cu. ft. | 4.3" | 14.5" | 14 lbs | |
| DDP150HFC227 | HFC-227 | 150 cu. ft. | 5.1" | 13.1" | 16 lbs | |
| DDP175HFC227 | HFC-227 | 175 cu. ft. | 5.1" | 15.5" | 18 lbs | |
| DDP200HFC227 | HFC-227 | 200 cu. ft. | 5.1" | 15.5" | 19 lbs | |
| DDP225HFC227 | HFC-227 | 225 cu. ft. | 6.4" | 14.7" | 28 lbs | |
| DDP250HFC227 | HFC-227 | 250 cu. ft. | 6.4" | 14.7" | 29 lbs | |
| DDP275HFC227 | HFC-227 | 275 cu. ft. | 6.4" | 14.7" | 30 lbs | |
| DDP300HFC227 | HFC-227 | 300 cu. ft. | 7.2" | 15.1" | 35 lbs | |
| DDP325HFC227 | HFC-227 | 325 cu. ft. | 7.2" | 15.1" | 36 lbs | |
| DDP350HFC227 | HFC-227 | 350 cu. ft. | 7.2" | 15.1" | 37 lbs | |
| DDP375HFC227 | HFC-227 | 375 cu. ft. | 7.0" | 18.8" | 38 lbs | |
| DDP400HFC227 | HFC-227 | 400 cu. ft. | 7.0" | 18.8" | 39 lbs | |
| DDP450HFC227 | HFC-227 | 450 cu. ft. | 7.0" | 18.8" | 41 lbs | |
| DDP500HFC227 | HFC-227 | 500 cu. ft. | 7.0" | 25.7" | 47 lbs | |
| DDP550HFC227 | HFC-227 | 550 cu. ft. | 7.0" | 25.7" | 49 lbs | |
| DDP600HFC227 | HFC-227 | 600 cu. ft. | 7.0" | 25.7" | 51 lbs | |
| DDP650HFC227 | HFC-227 | 650 cu. ft. | 7.0" | 25.7" | 53 lbs | |
| DDP700HFC227 | HFC-227 | 700 cu. ft. | 10.0" | 21.6" | 77 lbs | |
| DDP750HFC227 | HFC-227 | 750 cu. ft. | 10.0" | 21.6" | 79 lbs | |
| DDP800HFC227 | HFC-227 | 800 cu. ft. | 10.0" | 21.6" | 82 lbs | |
| DDP850HFC227 | HFC-227 | 850 cu. ft. | 10.0" | 21.6" | 84 lbs | |
| DDP900HFC227 | HFC-227 | 900 cu. ft. | 10.0" | 21.6" | 86 lbs | |
| DDP950HFC227 | HFC-227 | 950 cu. ft. | 10.0" | 21.6" | 88 lbs | |
| DDP1000HFC227 | HFC-227 | 1000 cu. ft. | 10.0" | 21.6" | 90 lbs | |
| DDP1050HFC227 | HFC-227 | 1050 cu. ft. | 10.0" | 21.6" | 92 lbs | |
| DDP1100HFC227 | HFC-227 | 1100 cu. ft. | 10.0" | 21.6" | 95 lbs | |
| DDP1150HFC227 | HFC-227 | 1150 cu. ft. | 10.0" | 21.6" | 97 lbs | |
| DDP1200HFC227 | HFC-227 | 1200 cu. ft. | 10.0" | 27.7" | 105 lbs | |
| DDP1250HFC227 | HFC-227 | 1250 cu. ft. | 10.0" | 27.7" | 107 lbs | |
| DDP1300HFC227 | HFC-227 | 1300 cu. ft. | 10.0" | 27.7" | 109 lbs | |
| DDP1350HFC227 | HFC-227 | 1350 cu. ft. | 10.0" | 27.7" | 111 lbs | |
| DDP1400HFC227 | HFC-227 | 1400 cu. ft. | 10.0" | 27.7" | 113 lbs | |
| DDP1450HFC227 | HFC-227 | 1450 cu. ft. | 10.0" | 27.7" | 116 lbs | |
| DDP1500HFC227 | HFC-227 | 1500 cu. ft. | 10.0" | 27.7" | 118 lbs | |



Fireboy® PANEL WARNING LIGHT features an attractive 2" round escutcheon plate with an adhesive back for easy panel mounting. The green warning lamp provides constant monitoring of the system, complying with USCG requirements for system approval.

| P/N | DESCRIPTION | EACH |
|--------|---|------|
| FBLKIT | Fire System Status Indicator Light w/ Panel | |



Fireboy® FIRE EXTINGUISHING SYSTEMS CABLES are for those who prefer the extra measure of control or for inspected vessels required to by USCG regulations. The normal mounting position of the manual discharge cable is at right angles to the panel for a straight-out pull.

| P/N | DESCRIPTION | EACH |
|------------|-----------------------------|------|
| E42096 | Manual Discharge Cable, 6' | |
| E42098 | Manual Discharge Cable, 8' | |
| E420910 | Manual Discharge Cable, 10' | |
| E420912 | Manual Discharge Cable, 12' | |
| E420914 | Manual Discharge Cable, 14' | |
| E420916 | Manual Discharge Cable, 16' | |
| E420918 | Manual Discharge Cable, 18' | |
| E420920 | Manual Discharge Cable, 20' | |
| E420922 | Manual Discharge Cable, 22' | |
| DDPE420924 | Manual Discharge Cable, 24' | |
| E420926 | Manual Discharge Cable, 26' | |
| E420928 | Manual Discharge Cable, 28' | |
| E420930 | Manual Discharge Cable, 30' | |



If fire breaks out aboard a diesel-powered vessel, continued operation may remove the agent, creating the possibility of re-ignition, but not with **Fireboy® AUTOMATIC SHUTDOWN SYSTEMS**. They respond automatically when a **Fireboy** system discharges. Available in three different model series, providing shutdown capability for up to eight different engines. All systems are solid state for greater reliability and come with an integrated alarm horn, charged/discharged lights, and an override switch for restart or control of auto shutdown.

| P/N | DESCRIPTION | EACH |
|-----------------|---|------|
| ES300001 | Diesel Engine Shutdown, 12V, 3-Circuit | |
| DDPES500001 | Diesel Engine Shutdown, 12V, 5-Circuit | |
| ES501501 | Diesel Engine Shutdown w/ GM Engine Time Delay, 12V, 5-Circuit | |
| DDPES800001 | Diesel Engine Shutdown, 12V, 8-Circuit | |
| DDPES8000012432 | Diesel Engine Shutdown, 24/32V, 8-Circuit | |
| DDPES801501 | Diesel Engine Shutdown w/ GM Engine Time Delay, 12V, 8-Circuit | |
| DDPES8015012432 | Diesel Engine Shutdown w/ GM Engine Time Delay, 24/32V, 8-Circuit | |

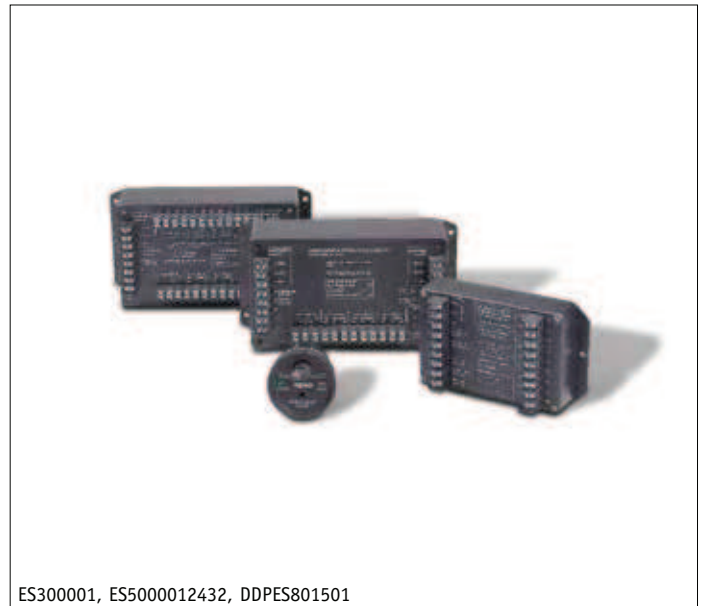



50ABCULC



50BCPAIL



AX555



A9336



K804904



AX506



AX5302



A430182



A423320



A79372



PC551188

RECHARGE CHEMICAL

Our **UL CLASSIFIED UNIVERSAL DRY CHEMICAL** is ideal for use in many manufacturers' fire extinguishers, per NFPA 10. This dry chemical agent consists of a carefully controlled range of particle sizes blended with a flow-promoting and anti-caking chemical for smooth delivery. Each particle is also silicone coated for optimum moisture repellency and minimum friction during discharge.

| P/N | DESCRIPTION | EACH |
|----------|--|------|
| 50ABCULC | UL Classified ABC Dry Chemical, 50 lbs | |

Our UNIVERSAL RECHARGE DRY CHEMICAL/POWDER

agents consist of a carefully controlled range of particle sizes of sodium bicarbonate or potassium bicarbonate blended with a flow-promoting and anti-caking chemical. The agents are formulated and manufactured for both long discharge range and smooth, uninterrupted flow. Each particle is also silicone coated to provide moisture repellency and minimum friction during discharge.

| P/N | DESCRIPTION | EACH |
|----------|--|------|
| 50BCPAIL | BC Dry Chemical, 50 lbs | |
| 50PKPAIL | Purple K Dry Chemical, 50 lbs | |
| 50DPAIL | Class D Dry Powder (Sodium Chloride), 50 lbs | |

OEM DRY CHEMICAL available from select warehouses. Call your Sales Representative for availability.

| P/N | DESCRIPTION | EACH |
|---------|---|------|
| AX555 | ABC "High Performance" Chemical, 45 lbs | |
| AX550 | Amerex ABC Dry Chemical, 50 lbs | |
| AX512 | Amerex BC Dry Chemical, 50 lbs | |
| A53080 | Ansul ABC Foray Dry Chemical, 45 lbs | |
| A9336 | Ansul Plus-Fifty C Dry Chemical | |
| B18905 | Badger ABC Dry Chemical, 50 lbs | |
| B18903 | Badger BC Dry Chemical, 50 lbs | |
| 24124B | Badger Class D Powder Recharge, 50 lbs | |
| 18907B | Badger Pk Dry Chemical, 50 lbs | |
| BK61000 | Buckeye ABC Dry Chemical, 50 lbs | |
| BK61400 | Buckeye BC Dry Chemical, 50 lbs | |
| K806411 | Kidde ABC Dry Chemical, 50 lbs | |
| K804904 | Kidde BC Dry Chemical, 50 lbs | |

OEM LIQUID CHEMICAL CHARGES for a wide variety of portable fire extinguisher types and models.

| P/N | DESCRIPTION | EACH |
|----------|--|------|
| AX506 | Amerex Antifreeze Charge for 2 1/2 gal Loaded Stream Extinguishers | |
| AX534 | Amerex FFFP Charge, 2 gal | |
| 504A | Amerex FFFP Premix Charge for 2 1/2 gal Extg., 1.14lit Model 252 | |
| AX5302 | Amerex Recharge for AX260, Pkg/2 | |
| AX660 | Amerex Recharge for AX262, Pkg/2 | |
| 502A | Amerex 2% AFFF Premix Charge for 2 1/2 gal & 6lit Extg., 8 1/2 oz Models 250, 250CG, 254 | |
| A430182 | Ansul PRX Liquid for K-Guard & Piranha, 6lit (K01, K01-1) | |
| A423320 | Ansul PRX Liquid for K-Guard & Piranha, 5 gal (K01, K01-1) | |
| A79372 | Ansulex Chemical Agent for K-Guard, 3 gal (K01-2) | |
| 792B | Badger Antifreeze Charge for WP-61 | |
| AC100 | Badger 6lit Recharge for WC100, Pkg/2 | |
| AC250 | Badger 2 1/2 gal Recharge for WC250 | |
| BK600872 | Buckeye 6lit Recharge | |
| PC551188 | RL-300, 3.0 gal Recharge Agent | |



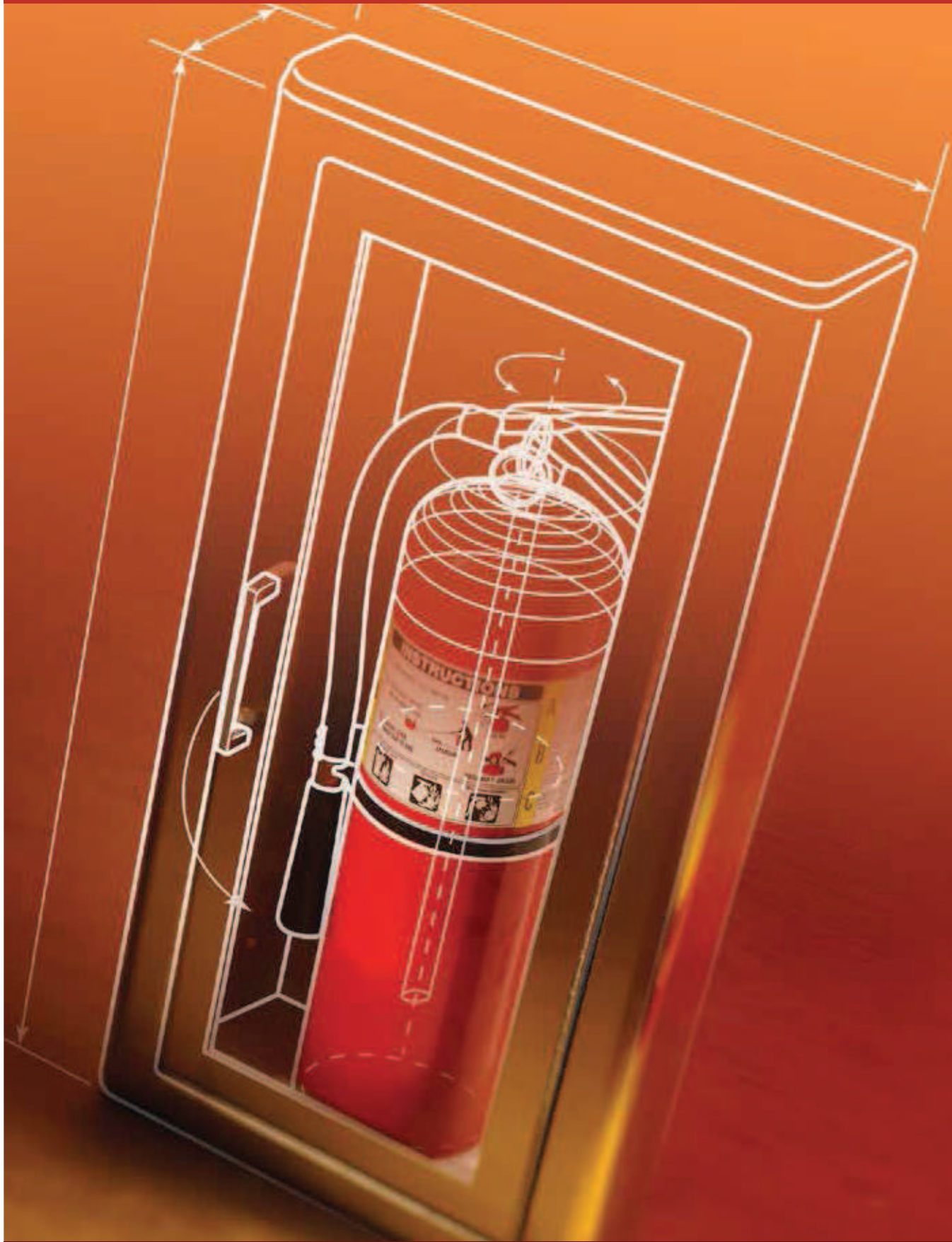

*Marketing For You: Personalized
catalogs and flyers.*

FIRE EXTINGUISHER CABINETS AND STANDS

Brooks' MARK SERIES FIRE EXTINGUISHER

CABINETS better fit today's extinguisher sizes. Cabinets feature injection molded ABS plastic construction, so they're dent-, rust-, and corrosion-proof. Each cabinet comes with a brass lock, a plastic cover, and a screen-printed pictogram on the side. With no glass to break, there's no breaker bar to lose. And since they're light and nest easily together, freight charges are a fraction of what metal cabinets can cost. Choose from three sizes: **Mark I Jr. Cabinets** for extinguishers with a maximum height of 16³/₄"; **Mark II Jr. Cabinets**, 20"; and **Mark II Cabinets**, 24". See sizing chart below for dimensions. Priced per cabinet.

MARK I JR. CABINET. Maximum extinguisher height, 16³/₄".

| P/N | DESCRIPTION | LOCATION | EACH |
|-------|-------------------------------------|----------------|------|
| MJM | Red Cabinet w/ Red Cover | Indoor/Outdoor | |
| MJM6 | Red Cabinet w/ Red Cover, Pkg/6 | Indoor/Outdoor | |
| MJRC | Red Cabinet w/ Clear Cover | Indoor | |
| MJRC6 | Red Cabinet w/ Clear Cover, Pkg/6 | Indoor | |
| MJWR | White Cabinet w/ Red Cover | Indoor | |
| MJWR6 | White Cabinet w/ Red Cover, Pkg/6 | Indoor | |
| MJWC | White Cabinet w/ Clear Cover | Indoor | |
| MJWC6 | White Cabinet w/ Clear Cover, Pkg/6 | Indoor | |

MARK II JR. CABINET. Maximum extinguisher height, 20".

| P/N | DESCRIPTION | LOCATION | EACH |
|--------|-------------------------------------|----------------|------|
| M2JM | Red Cabinet w/ Red Cover | Indoor/Outdoor | |
| M2JM6 | Red Cabinet w/ Red Cover, Pkg/6 | Indoor/Outdoor | |
| M2JRC | Red Cabinet w/ Clear Cover | Indoor | |
| M2JRC6 | Red Cabinet w/ Clear Cover, Pkg/6 | Indoor | |
| M2JWR | White Cabinet w/ Red Cover | Indoor | |
| M2JWR6 | White Cabinet w/ Red Cover, Pkg/6 | Indoor | |
| M2JWC | White Cabinet w/ Clear Cover | Indoor | |
| M2JWC6 | White Cabinet w/ Clear Cover, Pkg/6 | Indoor | |

MARK II CABINET. Maximum extinguisher height, 24".

| P/N | DESCRIPTION | LOCATION | EACH |
|-------|-------------------------------------|----------------|------|
| M2M | Red Cabinet w/ Red Cover | Indoor/Outdoor | |
| M2M6 | Red Cabinet w/ Red Cover, Pkg/6 | Indoor/Outdoor | |
| M2RC | Red Cabinet w/ Clear Cover | Indoor | |
| M2RC6 | Red Cabinet w/ Clear Cover, Pkg/6 | Indoor | |
| M2WR | White Cabinet w/ Red Cover | Indoor | |
| M2WR6 | White Cabinet w/ Red Cover, Pkg/6 | Indoor | |
| M2WC | White Cabinet w/ Clear Cover | Indoor | |
| M2WC6 | White Cabinet w/ Clear Cover, Pkg/6 | Indoor | |

NOTE: The MJM, M2JM and M2M cabinets are the only ones recommended for outdoor use.

MARK SERIES CABINETS and COVERS sizing chart.

| CABINET | A HEIGHT | B WIDTH | C DEPTH | MAX EXTR. HEIGHT |
|------------|----------------------------------|---------------------------------|---------------------------------|----------------------------------|
| MJ SERIES | 18 ¹ / ₄ " | 8 ¹ / ₂ " | 5 ³ / ₈ " | 16 ³ / ₄ " |
| M1 SERIES | 19 ⁵ / ₈ " | 8 ³ / ₄ " | 6 ¹ / ₂ " | 17 ³ / ₄ " |
| M2J SERIES | 21 ³ / ₄ " | 9 ⁵ / ₈ " | 6 ³ / ₈ " | 20" |
| M2 SERIES | 25 ³ / ₄ " | 9 ⁵ / ₈ " | 6 ³ / ₈ " | 24" |

| COVER | A HEIGHT | B WIDTH |
|------------|----------------------------------|-----------------------------------|
| MJ SERIES | 19 ¹ / ₄ " | 8 ⁷ / ₈ " |
| M1 SERIES | 20 ⁷ / ₈ " | 9 ³ / ₁₆ " |
| M2J SERIES | 23" | 10 ³ / ₁₆ " |
| M2 SERIES | 27" | 10 ³ / ₁₆ " |

NOTE: The "A Height" dimension is from the top of the cabinet to below where the padlock is attached, as shown in the diagram to the left.

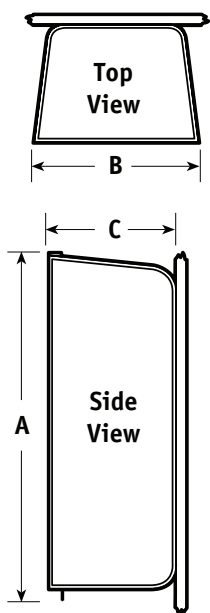

REPLACEMENT COVERS for **Brooks'** extinguisher cabinets.
See sizing chart on page 26 for dimensions. All prices are per cover.
NOTE: Individual covers are available—call your Sales Rep for pricing. Priced per cover.

| P/N | DESCRIPTION | EACH |
|--------|--|------|
| MJCR6 | Red Mark I Jr. Replacement Cover, Pkg/6 | |
| MJC6 | Clear Mark I Jr. Replacement Cover, Pkg/6 | |
| M1CR6 | Red Mark I Replacement Cover, Pkg/6 | |
| M1C6 | Clear Mark I Replacement Cover, Pkg/6 | |
| M2JCR6 | Red Mark II Jr. Replacement Cover, Pkg/6 | |
| M2JC6 | Clear Mark II Jr. Replacement Cover, Pkg/6 | |
| M2CR6 | Red Mark II Replacement Cover, Pkg/6 | |
| M2C6 | Clear Mark II Replacement Cover, Pkg/6 | |



FireTech™ FIRE EXTINGUISHER CABINETS work well indoors or out, thanks to their high-impact polystyrene construction and ultraviolet inhibitors that keep the color from fading, regardless of the weather or environment. Each cabinet includes an injection-molded frame, a scored break front, plastic cam lock with key, and a break-front striker. All **FireTech** parts are interchangeable with **CATO Chief Cabinets**.

| P/N | DESCRIPTION | H X W X D | EACH |
|---------|-------------------------------|--|------|
| FT5PR | Red FireTech Cabinet | 19" x 8" x 6 ³ / ₈ " | |
| FT5PR6 | Red FireTech Cabinet, Pkg/6 | 19" x 8" x 6 ³ / ₈ " | |
| FT5PW | White Firetech Cabinet | 19" x 8" x 6 ³ / ₈ " | |
| FT5PW6 | White Firetech Cabinet, Pkg/6 | 19" x 8" x 6 ³ / ₈ " | |
| FT10PR | Red FireTech Cabinet | 23" x 9" x 7" | |
| FT10PR6 | Red FireTech Cabinet Pkg/6 | 23" x 9" x 7" | |
| FT10PW | White Firetech Cabinet | 23" x 9" x 7" | |
| FT10PW6 | White Firetech Cabinet, Pkg/6 | 23" x 9" x 7" | |
| FT20PR | Red FireTech Cabinet | 28" x 11" x 9" | |
| FT20PW | White FireTech Cabinet | 28" x 11" x 9" | |



FireTech™ FIRE EXTINGUISHER CABINET ACCESSORIES

| P/N | DESCRIPTION | EACH |
|--------|---|------|
| FT5RF | FT5 Red Frame & Lock | |
| FT5WF | FT5 White Frame & Lock | |
| FT10RF | FT10 Red Frame & Lock | |
| FT10WF | FT10 White Frame & Lock | |
| FT20RF | FT20 Red Frame & Lock | |
| FT20WF | FT20 White Frame & Lock | |
| FT55 | FT5 Replacement Panel | |
| FT510 | FT10 Replacement Panel | |
| FT520 | FT20 Replacement Panel | |
| FTRCL | Cylinder Lock, Red | |
| FTWCL | Cylinder Lock, White | |
| FT100R | Break-Front Striker Assy. (Hammer Style), Red | |
| FT100W | Break-Front Striker Assy. (Hammer Style), White | |



Warrior FIRE EXTINGUISHER CABINET REPLACEMENT PANELS.

| P/N | DESCRIPTION | EACH |
|---------|-------------------------------|------|
| RCW5R* | 955 Replacement Panel, Red | |
| RCW10R* | 9510 Replacement Panel, Red | |
| RCW10C* | 9510 Replacement Panel, Clear | |

*WHILE QUANTITIES LAST!



2 CABINETS, ACCESSORIES, & COVERS



FGC35R, FGC26

A major step up in fire extinguisher storage and protection, **FireTech™ FIBERGLASS CABINETS** are designed to ward off salt air, chemicals, moisture, dust, insects, temperature extremes, and other harmful elements. These durably constructed cabinets feature a door-sealing method that shuts out most anything and an easy-view window and corrosion-resistant handle for extra convenience. All cabinets come standard with a full-length stainless steel hinge, rivets, and latches for added peace of mind. Comes in UV-resistant high-visibility red.

| P/N | A HEIGHT | B WIDTH | C DEPTH | MAX EXTR. HEIGHT | EACH |
|--------|----------------------------------|----------------------------------|----------------------------------|----------------------------------|------|
| FGC10 | 26 ¹ / ₈ " | 13" | 9" | 23 ¹ / ₂ " | |
| FGC26 | 27 ¹ / ₈ " | 15 ¹ / ₂ " | 9 ³ / ₄ " | 24 ¹ / ₂ " | |
| FGC35R | 36 ¹ / ₄ " | 19 ³ / ₈ " | 13 ¹ / ₂ " | 33 ¹ / ₄ " | |



FGC10



The **FireTech™ FIBERGLASS STAND** is designed for use with **FGC26 Fiberglass Cabinet**. Its red finish perfectly matches the cabinet and it comes with four pre-drilled holes for permanent attachment to docks or other locations. There are also mounting holes and hardware for attaching the cabinet. Sand can be added as well, for temporary placement. Measures 27¹/₂" tall with a 15¹/₂" x 15¹/₂" base and 8¹/₄" x 11³/₄" top surface.

| P/N | DESCRIPTION | EACH |
|--------|---|------|
| → FES2 | Fiberglass Cabinet Stand For FGC26 Cabinet | |

→ NEW

FES2



The **FireTech™ ABS EXTINGUISHER CABINET** protects extinguishers or life safety equipment from the harshest of environments. The clear door allows easy inspection, while the door-swing preference (left or right) and gasket provides long-term weather protection. A quick-release catch ensures rapid access to what's inside too.

| P/N | DESCRIPTION | H X W X D | EACH |
|-------|--------------------------|--------------------|------|
| FT101 | ABS Extinguisher Cabinet | 30" x 11" x 8 1/4" | |



FT101

Make moving fire extinguishers from job site to job site easy with this portable **FIRE EXTINGUISHER STAND**. It holds a 5, 10, or 20 lb dry chemical extinguisher and has a 16" x 16" base with a molded-in handle for ease of movement. There's also a large 2 1/2" fill hole for the addition of sand (up to 35 lbs). Constructed from red powder coated steel and predrilled for a fire extinguisher wall hook. **NOTE:** Sand and wall hook are not included.

| P/N | DESCRIPTION | EACH |
|------|-------------------------------|------|
| FES1 | Fire Extinguisher Stand, 48"H | |



FES1

The **Original Firemate™** is a stackable, portable fire extinguisher stand that's made of tough HDPE plastic. The stand holds 5, 10, or 20 pound extinguishers and its wide base resists tipping. OSHA compliant. Red.

NOTE: Fire extinguisher not included.

| P/N | DESCRIPTION | EACH |
|---------|----------------------------------|------|
| → FMRGC | Portable Fire Extinguisher Stand | |



→ **NEW**

FMRGC





Made of 20-gauge, galvanized steel, **FireTech™** surface-mount **METAL FIRE EXTINGUISHER CABINETS** are rust resistant and come with a white powder coat finish, keyed-alike cylinder lock, and scored polystyrene break fronts. Break-front striker sold separately. Ideal for interior or exterior use.

| P/N | DESCRIPTION | H X W X D | EACH |
|--------|--|--|------|
| FT916 | Cabinet | 19 ¹³ / ₁₆ " x 8 ¹ / ₂ " x 6 ¹ / ₄ " | |
| FT926 | Cabinet | 25 ³ / ₄ " x 9 ¹ / ₂ " x 6 ¹ / ₄ " | |
| FT936 | Cabinet | 29 ³ / ₄ " x 10 ¹ / ₂ " x 8 ¹ / ₄ " | |
| BEA003 | Replacement Top Panel w/ Lock For FT916 | | |
| BEA004 | Replacement Top Panel w/ Lock For FT926 | | |
| BEA005 | Replacement Top Panel w/ Lock For FT936 | | |

Surface-mount **Classic Series METAL FIRE**

EXTINGUISHER CABINETS are made of 20-gauge galvanized steel with a bright white finish, keyed-alike cylinder lock, and breakable polystyrene front. Break-front striker sold separately.

| P/N | DESCRIPTION | H X W X D | EACH |
|--------|--|--|------|
| BE916 | Cabinet, Pkg/2 | 19 ¹³ / ₁₆ " x 8 ¹ / ₂ " x 6 ¹ / ₄ " | |
| BE926 | Cabinet, Pkg/2 | 25 ³ / ₄ " x 9 ¹ / ₂ " x 6 ¹ / ₄ " | |
| BE936 | Cabinet, Pkg/2 | 29 ³ / ₄ " x 10 ¹ / ₂ " x 8 ¹ / ₄ " | |
| BEA003 | Replacement Top Panel w/ Lock For BE916 | | |
| BEA004 | Replacement Top Panel w/ Lock For BE926 | | |
| BEA005 | Replacement Top Panel w/ Lock For BE936 | | |

Decorline FIRE EXTINGUISHER CABINETS are

constructed from cold-rolled steel with a white baked-on finish.

They are equipped with 2" projecting trim to hide your wall cutout and a sliding acrylic break-out front for easy access.

Break-front striker and lock sold separately. Priced per cabinet.

| P/N | TRIM | TUB ID | | | FRAME OD | | WALL OPENING | | |
|--------|---------------------------------|--------|---------------------------------|---------------------------------|----------|----------------------------------|--------------|-----|----|
| | | H | W | D | H | W | H | W | D |
| 818TW1 | 2 ¹ / ₂ " | 18" | 8 ¹ / ₈ " | 5 ¹ / ₂ " | 21" | 11 ¹ / ₈ " | 19" | 9" | 4" |
| 818TW3 | 2 ¹ / ₂ " | 18" | 8 ¹ / ₈ " | 5 ¹ / ₂ " | 21" | 11 ¹ / ₈ " | 19" | 9" | 4" |
| 924TW1 | 2 ¹ / ₂ " | 24" | 9 ¹ / ₈ " | 5 ¹ / ₂ " | 27" | 12 ¹ / ₈ " | 25" | 10" | 4" |
| 924TW3 | 2 ¹ / ₂ " | 24" | 9 ¹ / ₈ " | 5 ¹ / ₂ " | 27" | 12 ¹ / ₈ " | 25" | 10" | 4" |

| P/N | DESCRIPTION | EACH |
|--------|----------------|------|
| 818TW1 | Cabinet | |
| 818TW3 | Cabinet, Pkg/3 | |
| 924TW1 | Cabinet | |
| 924TW3 | Cabinet, Pkg/3 | |

Economyline FIRE EXTINGUISHER CABINETS are

constructed from cold-rolled steel with a Hammertone gray or white baked-on finish. Cabinets are also equipped with a sliding acrylic break-out front. Break-front striker and lock sold separately. Priced per cabinet.

| P/N | DESCRIPTION | H X W X D (INTERIOR) | EACH |
|--------|----------------------|--|------|
| 818G1 | Gray Cabinet | 18" x 8 ¹ / ₈ " x 5 ¹ / ₂ " | |
| 818G6 | Gray Cabinet, Pkg/6 | 18" x 8 ¹ / ₈ " x 5 ¹ / ₂ " | |
| 818W1 | White Cabinet | 18" x 8 ¹ / ₈ " x 5 ¹ / ₂ " | |
| 818W6 | White Cabinet, Pkg/6 | 18" x 8 ¹ / ₈ " x 5 ¹ / ₂ " | |
| 924G1 | Gray Cabinet | 24" x 9 ¹ / ₈ " x 5 ¹ / ₂ " | |
| 924G4 | Gray Cabinet, Pkg/4 | 24" x 9 ¹ / ₈ " x 5 ¹ / ₂ " | |
| 924W1 | White Cabinet | 24" x 9 ¹ / ₈ " x 5 ¹ / ₂ " | |
| 924W4 | White Cabinet, Pkg/4 | 24" x 9 ¹ / ₈ " x 5 ¹ / ₂ " | |
| 1028G2 | Gray Cabinet, Pkg/2 | 28" x 10 ¹ / ₈ " x 8 ¹ / ₄ " | |
| 1028W2 | White Cabinet, Pkg/2 | 28" x 10 ¹ / ₈ " x 8 ¹ / ₄ " | |

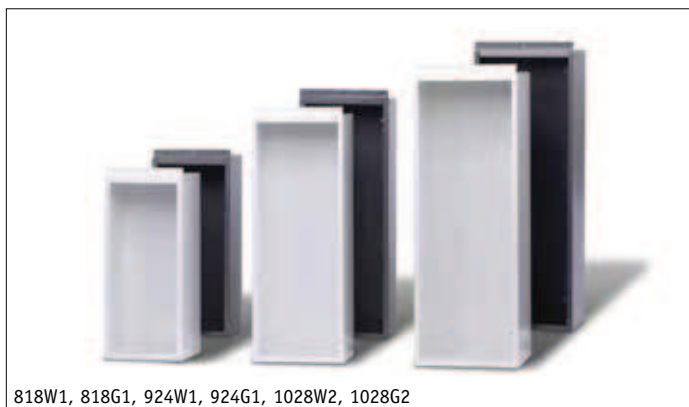

The **ACADEMY, AMBASSADOR, and COSMOPOLITAN SERIES CABINETS**, manufactured by **J.L. Industries**, are some of the finest cabinets available. They are made of aluminum with a clear anodized finish (**Academy**) or steel with electrostatic white epoxy primer finish (**Ambassador**) or all stainless steel (**Cosmopolitan**). All cabinets include a continuous hinge door and acrylic front with squared edge construction. (The 3" trim model has rolled edge construction).

Three different acrylic door styles are stocked too: **Full Acrylic**, **Full Acrylic with Saf-T-Lok**, and **Contemporary V. Full Acrylic** and **Contemporary V** models are equipped with zinc-plated pull handles and roller catches, while the **Full Acrylic with Saf-T-Lok** models use pull handles with keyed-alike cylinder locks and flexible cams.

NOTE: Remember to add the wall material thickness to your wall depth when determining the cabinet you need. Not responsible for acrylic breakage during shipping.

| MODELS | TRIM | TUB ID | | | FRAME OD | | WALL OPENING | | |
|--------|---------------------------------|-----------------------------------|------------------------------------|---------------------------------|----------------------------------|----------------------------------|----------------------------------|----------------------------------|---------------------------------|
| | | A | B | C | E | F | H | W | D |
| 1013 | Surf | 27 ³ / ₁₆ " | 13 ¹¹ / ₁₆ " | 6 ¹ / ₂ " | 27 ³ / ₈ " | 13 ⁷ / ₈ " | - | - | - |
| 1015 | Flat | 24" | 10 ¹ / ₂ " | 6" | 27 ³ / ₈ " | 13 ⁷ / ₈ " | 25" | 11 ¹ / ₂ " | 6" |
| 1017 | 3" | 24" | 10 ¹ / ₂ " | 6" | 27 ³ / ₈ " | 13 ⁷ / ₈ " | 25" | 11 ¹ / ₂ " | 3 ¹ / ₈ " |
| 1017FX | 3" | 24" | 10 ¹ / ₂ " | 6" | 27 ³ / ₈ " | 13 ⁷ / ₈ " | 26 ¹ / ₈ " | 12 ¹ / ₂ " | 4" |
| 1413 | Surf | 17 ³ / ₁₆ " | 17 ³ / ₁₆ " | 7" | 17 ³ / ₈ " | 17 ³ / ₈ " | - | - | - |
| 1417 | 3" | 14" | 14" | 6 ³ / ₄ " | 17 ³ / ₈ " | 17 ³ / ₈ " | 15 ¹ / ₄ " | 15 ¹ / ₄ " | 3 ³ / ₄ " |
| 1815 | Flat | 24" | 10 ¹ / ₂ " | 5 ¹ / ₂ " | 27 ³ / ₈ " | 13 ⁷ / ₈ " | 25" | 11 ¹ / ₂ " | 5 ¹ / ₂ " |
| 1816 | 1 ¹ / ₂ " | 24" | 10 ¹ / ₂ " | 5 ¹ / ₂ " | 27 ³ / ₈ " | 13 ⁷ / ₈ " | 25" | 11 ¹ / ₂ " | 4" |
| 1817 | 3" | 24" | 10 ¹ / ₂ " | 5 ¹ / ₂ " | 27 ³ / ₈ " | 13 ⁷ / ₈ " | 25" | 11 ¹ / ₂ " | 2 ⁵ / ₈ " |
| 2015 | Flat | 27" | 12" | 7 ³ / ₄ " | 30 ³ / ₈ " | 15 ³ / ₈ " | 28" | 13" | 7 ³ / ₄ " |
| 1027 | 3" | 24" | 10 ¹ / ₂ " | 6" | 27 ³ / ₈ " | 13 ⁷ / ₈ " | 25" | 11 ¹ / ₂ " | 3 ¹ / ₈ " |
| 1037 | 3" | 24" | 10 ¹ / ₂ " | 6" | 27 ³ / ₈ " | 13 ⁷ / ₈ " | 25" | 11 ¹ / ₂ " | 3 ¹ / ₈ " |
| 1037FX | 3" | 24" | 10 ¹ / ₂ " | 6" | 27 ³ / ₈ " | 13 ⁷ / ₈ " | 26 ¹ / ₈ " | 12 ¹ / ₂ " | 4" |

AMBASSADOR SERIES CABINETS

| P/N | DESCRIPTION | EACH |
|-----------|--|------|
| 1013F10 | Surface Mount, Full Acrylic | |
| 1015F10 | Flat Trim, Full Acrylic | |
| 1017F10 | 3" Trim, Full Acrylic | |
| 1017F10FX | 3" Trim, Full Acrylic (Fire Rated) | |
| 1815F10 | Flat Trim, Full Acrylic | |
| 1816F10 | 1 ¹ / ₂ " Trim, Full Acrylic | |
| 1817F10 | 3" Trim, Full Acrylic | |
| 2015F10 | Flat Trim, Full Acrylic | |
| 1017S21 | 3" Trim, Solid Door | |
| P/N | DESCRIPTION | EACH |
| 1013G10 | Surface Mount (w/ Saf-T-Lok Door) | |
| 1015G10 | Flat Trim (w/ Saf-T-Lok Door) | |
| 1017G10 | 3" Trim (w/ Saf-T-Lok Door) | |
| 1815G10 | Flat Trim (w/ Saf-T-Lok Door) | |
| 1816G10 | 1 ¹ / ₂ " Trim (w/ Saf-T-Lok Door) | |
| 1817G10 | 3" Trim (w/ Saf-T-Lok Door) | |
| 2015G10 | Flat Trim (w/ Saf-T-Lok Door) | |
| JLLC | Saf-T-Lok Cam | |

The **AMBASSADOR SERIES CABINETS** with **Contemporary** vertical duo panel door.

| P/N | DESCRIPTION | EACH |
|------------|--------------------------------------|------|
| 1013V10 | Surface Mount | |
| 1013V10RRR | Surface Mount (Red) | |
| 1015V10 | Flat Trim | |
| 1017V10 | 3" Trim | |
| 1815V10 | Flat Trim | |
| 1816V10 | 1 ¹ / ₂ " Trim | |
| 1817V10 | 3" Trim | |
| 2015V10 | Flat Trim | |

ACADEMY and COSMOPOLITAN SERIES CABINETS with Full Acrylic door.

| P/N | DESCRIPTION | EACH |
|-----------|---------------------------|------|
| 1027F10 | 3" Trim (Aluminum) | |
| 1037F10 | 3" Trim (Stainless Steel) | |
| 1037F10FX | 3" Trim (Fire Rated) | |

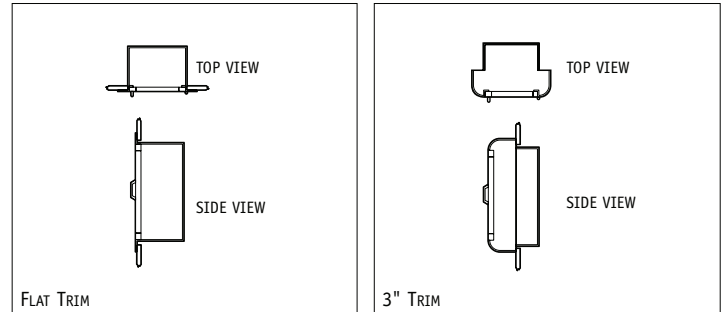
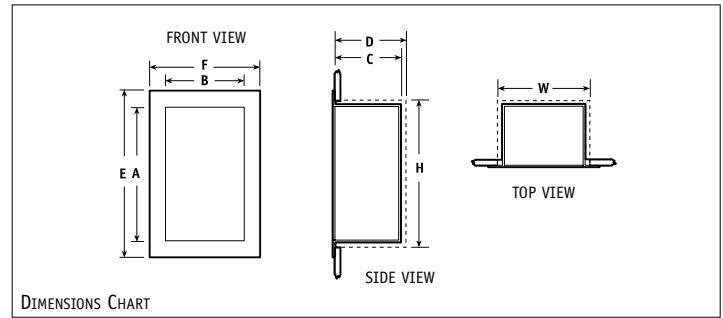

2 CABINETS, ACCESSORIES, & COVERS

CABINET ACCESSORIES

FireTech™ Economyline, Decorline, and Classic Series fire extinguisher cabinet **ACCESSORIES** include replacement cabinet covers, glass clips, and break front tools. The clear replacement covers are grid-scored for faster and easier access to fire extinguishers. Injection-molded polystyrene covers are screen-printed so respondents know exactly where to strike in case of fire. (See-through scored covers are much easier to break than un-scored versions.)

| P/N | DESCRIPTION | EACH |
|---------|--|------|
| SAC818 | Scored Polystyrene Break Front, Clear For BE916, FT916 & 818 Series Cabinets, 17 ⁷ / ₈ " x 8" | |
| SAC924 | Scored Polystyrene Break Front, Clear For BE926, FT926 & 924 Series Cabinets, 23 ⁷ / ₈ " x 9" | |
| SAC1028 | Scored Polystyrene Break Front, Clear For BE936, FT936 & 1028 Series Cabinets, 27 ⁷ / ₈ " x 10" | 1 |
| 818C | 8" Glass Clip, Gray Fits Economyline & Decorline Cabinets | |
| 818CW | 8" Glass Clip, White Fits Economyline & Decorline Cabinets | |
| 924C | 9" Glass Clip, Gray Fits Economyline & Decorline Cabinets | |
| 924CW | 9" Glass Clip, White Fits Economyline & Decorline Cabinets | |
| 1028C | 10" Glass Clip, Gray Fits all Economyline & Decorline Cabinets | |
| 1028CW | 10" Glass Clip, White Fits all Economyline & Decorline Cabinets | |
| BR13 | Break Front Striker Assy. (Bar Style) | |
| BGH6 | Break Front Striker Assy. (Hammer Style) | |
| FT100R | Break-Front Striker Assy. (Hammer Style), Red | |
| FT100W | Break-Front Striker Assy. (Hammer Style), White | |

A **Brooks'** exclusive, these fire extinguisher **CABINET ALARMS** sound off with a 105 dB alarm when the extinguisher is removed. They're self-adhesive and install in seconds. Measures 2³/₄"H x 2¹/₄"W x 1"D. Batteries not included.

| P/N | DESCRIPTION | EACH |
|-------|---------------------|--------------|
| CFAW | White Cabinet Alarm | |
| CFAR | Red Cabinet Alarm | |
| ALK22 | 9V Alkaline Battery | SEE PAGE 142 |

STI's FIRE EXTINGUISHER THEFT STOPPER helps stop theft, vandalism, and misuse of fire extinguishers. If the protected fire extinguisher is moved or jostled, **Theft Stopper** emits an instantaneous piercing alarm. Plus there's a highly visible "STOP, EMERGENCY USE ONLY" to further deter unauthorized handling. The **Theft Stopper** is simple to install and comes with a deactivation cable (for when extinguisher needs servicing). Red.

| P/N | DESCRIPTION | EACH |
|---------|---------------------------------|------|
| STI6200 | Fire Extinguisher Theft Stopper | |

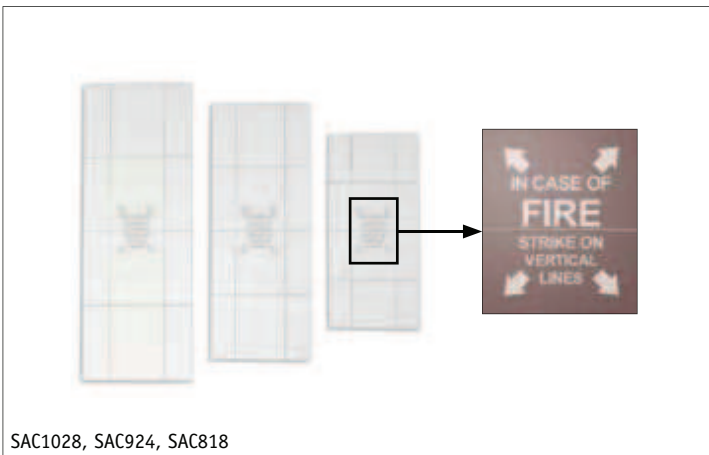

SAC1028, SAC924, SAC818



818CW



BGH6



BR13



CFAW In Use



STI6200 In Use



These **FIRE EXTINGUISHER DECALS** are for labeling cabinets and bubble covers as required by various AHJs. Choice of horizontal or vertical decals with red lettering on clear background.

| P/N | DESCRIPTION | H X W | EACH |
|-------|--------------------------------------|------------------|------|
| BL253 | "Fire Extinguisher" for Cabinet | 19" x 2" | |
| BL254 | "Fire Extinguisher" for Cabinet | 2 1/4" x 7 1/8" | |
| BL255 | "Fire Extinguisher" for Small Bubble | 13" x 3/8" | |
| BL256 | "Fire Extinguisher" for Large Bubble | 16 1/2" x 1 1/2" | |



Brooks' BUBBLE COVERS are designed for use on metal extinguisher cabinets with full door styles. Both models offer transparency for good extinguisher visibility. Polycarbonate models offer extra strength for added security. Decals sold separately.

| P/N | DESCRIPTION | H X W X D | EACH |
|-------|-------------------------------|-----------------------|------|
| ABUB1 | Extra-Small Acrylic (Larsens) | 21 1/2" x 6 3/4" x 4" | |
| ABUB2 | Small Acrylic (JL) | 22 1/4" x 8 1/2" x 4" | |
| ABUB3 | Large Acrylic (JL) | 28" x 11 15/16" x 5" | |
| ABUB4 | Large Acrylic (Larsens Steel) | 28 1/2" x 12 3/5" | |
| ABUB5 | Large Acrylic (Larsens Alum) | 29 1/2" x 13 1/4" | |
| PBUB1 | Extra Small Poly (Larsens) | 21 1/2" x 6 3/4" x 4" | |
| PBUB2 | Small Poly (JL) | 22 1/4" x 8 1/2" x 4" | |
| PBUB3 | Large Poly (JL) | 28" x 11 15/16" x 5" | |
| PBUB4 | Large Poly (Larsens) | 28 1/2" x 12 3/5" | |
| PBUB5 | Large Poly (Larsens) | 29 1/2" x 13 1/4" | |



BREAKAWAY BRASS PADLOCK is for securing cabinets and other equipment until needed in an emergency. Designed to be opened with a key or broken away. Inside shackle height is 7/8".

| P/N | DESCRIPTION | EACH |
|-------|-------------------------------------|------|
| SBL66 | Keyed-Alike Breakaway Brass Padlock | |

Master Lock® is a name synonymous with quality padlocks. The keyed-alike **BREAKAWAY STEEL PADLOCK** has a 1 3/4"-wide laminated steel body for superior strength and comes with two keys and a steel shackle for superior cut resistance. A warded locking mechanism helps minimize jamming caused by dirt and grime. And it's rustproof. Inside shackle height is 13/16".

| P/N | DESCRIPTION | EACH |
|---------|-------------------------------------|------|
| ML500KA | Keyed-Alike Breakaway Steel Padlock | |

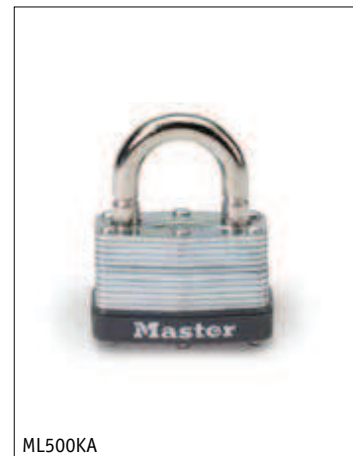

Corrosion-resistant **PADLOCK** features an all-brass shackle, making it ideal for cabinets and other security requirements where economy and keyed-alike convenience is essential. Inside shackle height is 5/8".

| P/N | DESCRIPTION | EACH |
|------|---------------------------|------|
| M12L | Keyed-Alike Brass Padlock | |

Abus' ECONOMY PADLOCK is designed for cabinet use and comes with a steel shackle. Keyed-alike. Inside shackle height is 3/4". Blue.

| P/N | DESCRIPTION | EACH |
|--------|----------------------|------|
| 1635AB | Abus Economy Padlock | |



2 CABINETS, ACCESSORIES, & COVERS



PPL



MS5100



MS5100 In Use

Single-use **PLASTIC PADLOCKS** must be cut or broken away. Inside shackle height is $\frac{3}{4}$ ". Red.

| P/N | DESCRIPTION | EACH |
|-----|--------------------------|------|
| PPL | Red Plastic Padlock Seal | |

ADHESIVE-BACKED MAGNETIC STRIP makes mounting signs, breaker bars, and other metal goods a snap. **MS5100** is designed to withstand temperatures from -40°F to 160°F . Each **Magnetic Strip** comes with a peel-off liner and durable outdoor adhesive for good adherence. Sold in easy-to-cut rolls.

| P/N | DESCRIPTION | EACH |
|--------|---|------|
| MS5100 | Adhesive Magnetic Strip, $\frac{1}{2}$ " x 100' | |



BR13

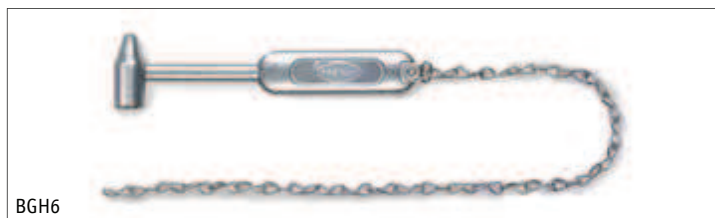

BGH6

BREAK FRONT STRIKERS are designed to easily break glass or plastic break-front-type cabinet covers.

| P/N | DESCRIPTION | EACH |
|--------|---|------|
| BR13 | Break Front Striker Assy (Bar Style) | |
| BGH6 | Break Front Striker Assy (Hammer Style) | |
| FT100R | Break-Front Striker Assy. (Hammer Style), Red | |
| FT100W | Break-Front Striker Assy. (Hammer Style), White | |



PTD182

3-D RIGID PLASTIC ANGLE SIGNS

| P/N | DESCRIPTION | L X H |
|---------|--------------------------------------|-----------|
| PTD108 | "Fire Extinguisher" Arrow | 4" x 12" |
| PTD109 | "Fire Extinguisher" Arrow | 4" x 18" |
| PTD182 | "Fire Extinguisher" Arrow | 5" x 6" |
| PTD109B | "Fire Extinguisher" Arrow, Bilingual | 11" x 18" |



PTD109B

NOTE: For More Signs, Please See Section 9.



Auxiliary **CABINET KEY SET** will open **Brooks, FireTech™, Cato, J.L. Industries, Larsen's, Modern Metal, Potter Roemer, Rome Metal, Samson, Heiser, and Thomas Enterprises** fire extinguisher cabinets. Set includes a durable cross reference tag for easy identification.

| | | |
|------------|--------------------|-------------|
| P/N | DESCRIPTION | EACH |
| CKS | Cabinet Key Set | |



CKS

The **UNIVERSAL CAM LOCK** assembly is for changing out damaged or worn-out locks and is adaptable to most cabinets. Comes with two cam choices or use the one off the old lock.

| | | |
|------------|--|-------------|
| P/N | DESCRIPTION | EACH |
| UCL | Replacement Universal Cam Lock w/ Keys | |



UCL



JLHP

JL Cabinets HARDWARE PACK and **CAM LOCK ASSEMBLY** work perfectly with your **JL Cabinets**. The **Cam Lock Assembly** replaces old, worn-out cam locks on **JL Cabinets**. **Hardware Pack** includes a friction roller catch and glass clips.

| | | |
|------------|--------------------------------------|-------------|
| P/N | DESCRIPTION | EACH |
| JLHP | Hardware Pack for JL Cabinets | |
| JLSL | Safety Cam Lock Assy for JL Cabinets | |



JLSL



JLLC

| | | |
|------------|--------------------|-------------|
| P/N | DESCRIPTION | EACH |
| JLLC | Saf-T-Lok Cam | |

KEY BOX

Keep track of keys with this **KEY BOX** from **Brooks**. It's made of durable ABS plastic in a two-piece design that allows for easier access in an emergency. The polystyrene cover snaps right into place. Measures 4 1/4" x 1 1/4". Red.

| | | |
|------------|--|-------------|
| P/N | DESCRIPTION | EACH |
| BKB | ABS Key Box "Break Glass For Key," New Style | |
| KBRC | Replacement Plastic Cover for BKB | |
| RKBB | Replacement Plastic Cover for Old Style Key Box (KB) | |



BKB

LOCK BOX

16-gauge steel **FIRE DEPARTMENT LOCK BOX** adds up to a lot of security. Measures 6"H x 4"W x 1 1/2"D. Red.

| | | |
|------------|--------------------------|-------------|
| P/N | DESCRIPTION | EACH |
| LBFD | Fire Department Lock Box | |



LBFD





FEC1



FEC1W



FEC4E



FEC4EW



FEC8



WUC1



WUC3



FHDC1

VINYL COVERS

Brooks FIRE EXTINGUISHER COVERS are made of reinforced vinyl with hook-and-loop closures or elastic-back and pull bottom tabs/straps for easy, long-lasting use. Covers fit portable, pressurized, and cartridge-operated extinguishers. Red.

| P/N | DESCRIPTION | H X W | EACH |
|-------|---|------------|------|
| FEC1 | Small Cover w/ Hook-and-Loop Closure | 20" x 11½" | |
| FEC1W | Small Cover w/ Hook-and-Loop Closure, Window | 20" x 11½" | |
| FEC2 | Medium Cover w/ Hook-and-Loop Closure | 25" x 16½" | |
| FEC2W | Medium Cover w/ Hook-and-Loop Closure, Window | 25" x 16½" | |
| FEC3 | Large Cover w/ Hook-and-Loop Closure | 31" x 16½" | |
| FEC3W | Large Cover w/ Hook-and-Loop Closure, Window | 31" x 16½" | |

| P/N | DESCRIPTION | H X W X D | EACH |
|--------|--|----------------|------|
| FEC4E | Extra Small Cover w/ Elastic-Back, Pull Bottom Tab | 18½" x 7" x 6" | |
| FEC4EW | Extra Small Cover w/ Elastic-Back, Pull Bottom Tab, Window | 18½" x 7" x 6" | |
| FEC5E | Small Cover w/ Elastic-Back, Pull Bottom Strap | 22½" x 6¼" | |
| FEC5EW | Small Cover w/ Elastic-Back, Pull Bottom Strap, Window | 22½" x 6¼" | |
| FEC6E | Medium Cover w/ Elastic-Back, Pull Bottom Strap | 25½" x 8" | |
| FEC6EW | Medium Cover w/ Elastic-Back, Pull Bottom Strap, Window | 25½" x 8" | |

HEAVY-DUTY FIRE EXTINGUISHER COVERS are made of acrylic coated polyester with hook-and-loop closures, for the harshest conditions. (Based on test results, covers have a minimum five-year lifespan outdoors under normal conditions.) Covers fit portable, pressurized, and cartridge-operated extinguishers. Red.

| P/N | DESCRIPTION | H X W | EACH |
|-------|-------------------|------------|------|
| FEC10 | Extra-Small Cover | 18½" x 7" | |
| FEC7 | Small Cover | 20" x 11½" | |
| FEC8 | Medium Cover | 25" x 16½" | |
| FEC9 | Large Cover | 31" x 16½" | |

WHEELED UNIT COVERS feature the same qualities as the **Fire Extinguisher Covers**, in standard or heavy-duty material. Red.

| P/N | DESCRIPTION | H X W X D | EACH |
|-------|---|------------------|------|
| WUC50 | 50 lb DC Cover | 47½" x 16" x 24" | |
| WUC3 | 50 & 75 lb CO ₂ Cover | 54" x 16" x 27" | |
| WUC6 | 50 & 75 lb CO ₂ Heavy-Duty Cover | 54" x 16" x 27" | |
| WUC1 | 150 lb Cover | 53" x 42" x 30" | |
| WUC4 | 150 lb Heavy-Duty Cover | 53" x 42" x 30" | |
| WUC2 | 350 lb Cover | 58" x 52" x 38" | |
| WUC5 | 350 lb Heavy-Duty Cover | 58" x 52" x 38" | |

HEAVY-DUTY FIRE HYDRANT COVERS are made of reinforced vinyl with hook-and-loop closures and come with reinforced grommets that allow for chain/wire attachment to prevent removal. Fluorescent Red.

| P/N | DESCRIPTION | EACH |
|-------|-------------------------------|------|
| FHDC1 | Heavy-Duty Fire Hydrant Cover | |



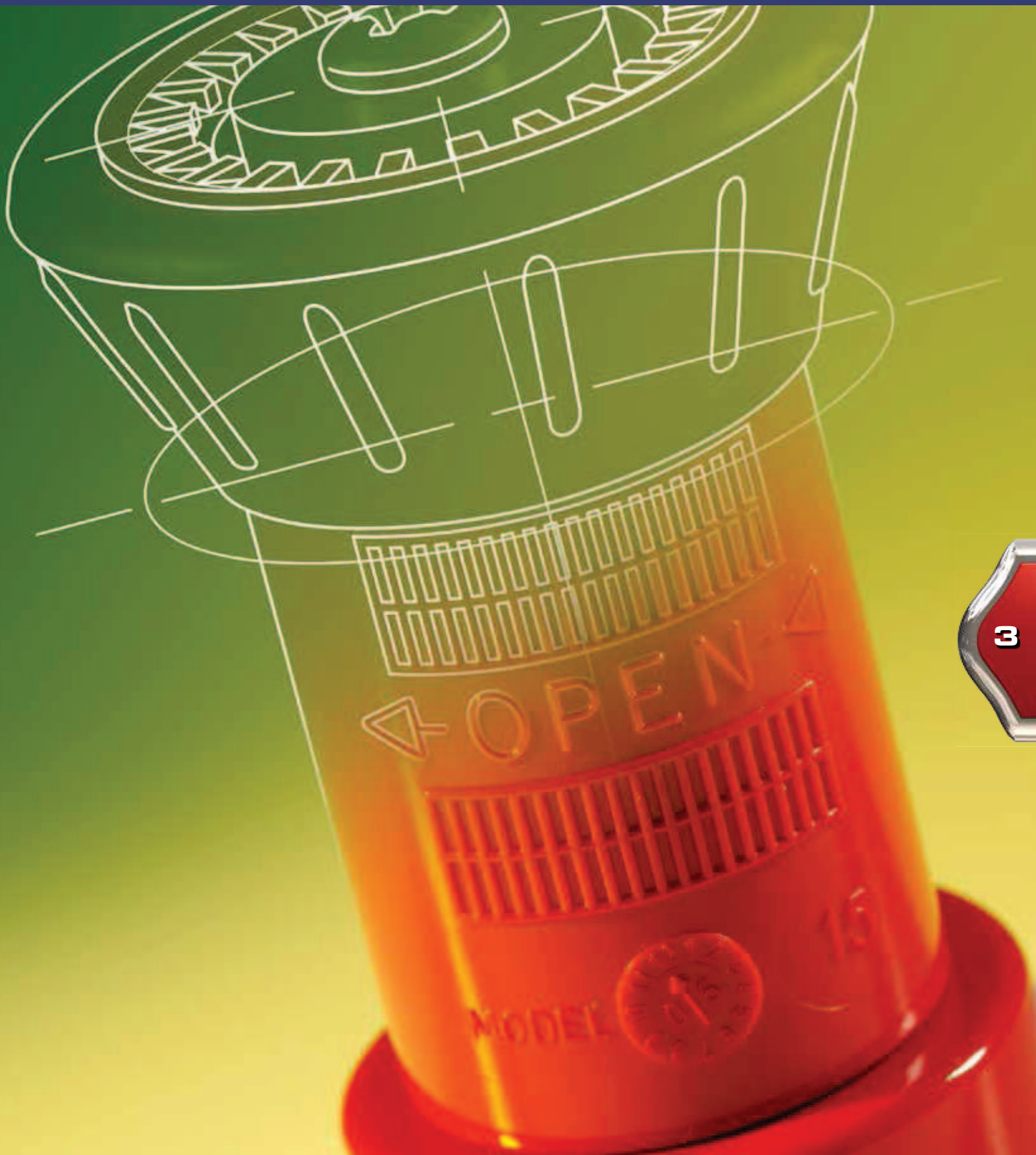

In Stock: Largest selection in the industry—over 6,000 parts.

A Step Up In Quality!

A step up from standard **Rack & Reel Fire Hose**, and a great value, **FireTech's SINGLE JACKET FIRE HOSE** has a proof test pressure of 500 psi and a service test of 250 psi. It's FM approved and made of 100% polyester rubber-lined material for extra strength and flexibility. Imported.

NOTE: Recommended for industrial fire protection.

| P/N | DESCRIPTION | BOWL SIZE | WEIGHT COUPLED | EACH |
|--------------------|------------------------|-----------|----------------|------|
| FTSJ50NST or NPSH* | 50' x 1 1/2" Brass | 1 13/16" | 15 lbs | |
| FTSJ75NST | 75' x 1 1/2" Brass | 1 13/16" | 20 lbs | |
| FTSJ100NST | 100' x 1 1/2" Brass | 1 13/16" | 27 lbs | |
| FTSJ2550NST | 50' x 2 1/2" Brass | 2 13/16" | 27 lbs | |
| FTSJ50ANST* | 50' x 1 1/2" Aluminum | 1 13/16" | 13 lbs | |
| FTSJ100ANST* | 100' x 1 1/2" Aluminum | 1 13/16" | 25 lbs | |

*WHILE SUPPLIES LAST!

FTSJ50NST

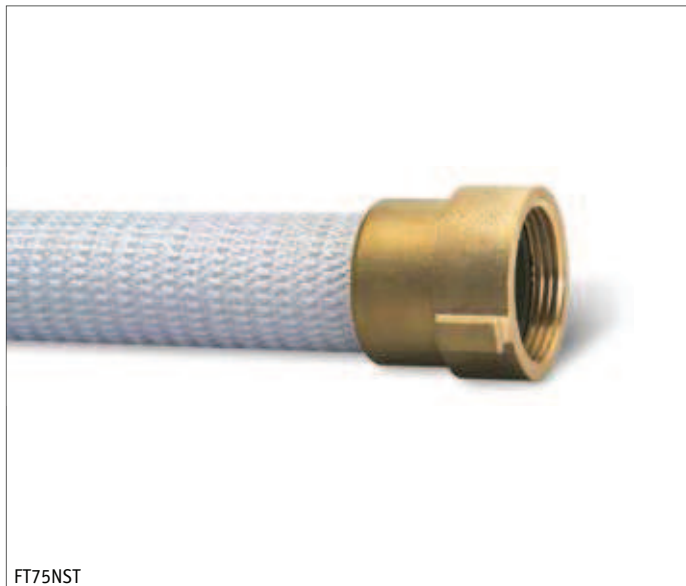

FT75NST

FIRE HOSE

For emergency use only, **FireTech™ RACK & REEL FIRE HOSE** is fully lined, FM approved, and a great value. It has a proof test pressure of 500 psi, service test of 250 psi, and comes folded for easy installation on pin racks. Brass couplings only. Imported.

NOTE: Not intended for purposes of wash down!

| P/N | DESCRIPTION | BOWL SIZE | WEIGHT COUPLED | EACH |
|------------------|---------------------|-----------|----------------|------|
| FT50NST or NPSH | 50' x 1 1/2" Brass | 1 11/16" | 7 lbs | |
| FT75NST or NPSH | 75' x 1 1/2" Brass | 1 11/16" | 9 lbs | |
| FT100NST or NPSH | 100' x 1 1/2" Brass | 1 11/16" | 12 lbs | |

For emergency use only, this **RACK & REEL FIRE HOSE** is fully lined and FM approved. It has a proof test pressure of 500 psi, service test of 250 psi, and comes folded for easy installation on pin racks. Brass couplings only.

NOTE: Not intended for purposes of wash down!

| P/N | DESCRIPTION | BOWL SIZE | WEIGHT COUPLED | EACH |
|--------|---------------------|-----------|----------------|------|
| 50NST | 50' x 1 1/2" Brass | 1 11/16" | 7 lbs | |
| 75NST | 75' x 1 1/2" Brass | 1 11/16" | 9 lbs | |
| 100NST | 100' x 1 1/2" Brass | 1 11/16" | 12 lbs | |

A step up from standard **Rack & Reel Fire Hose**, our **SINGLE JACKET FIRE HOSE** has a proof test pressure of 500 psi and a service test of 250 psi. It's FM approved and made of 100% polyester rubber-lined material for extra strength and flexibility.

NOTE: Recommended for industrial fire protection.

| P/N | DESCRIPTION | BOWL SIZE | WEIGHT COUPLED | EACH |
|-------------------|---------------------|-----------|----------------|------|
| SJ50NST or NPSH | 50' x 1 1/2" Brass | 1 13/16" | 15 lbs | |
| SJ50ANST | 50' x 1 1/2" Alum | 1 13/16" | 13 lbs | |
| SJ75NST or NPSH | 75' x 1 1/2" Brass | 1 13/16" | 20 lbs | |
| SJ75ANST | 75' x 1 1/2" Alum | 1 13/16" | 18 lbs | |
| SJ100NST or NPSH | 100' x 1 1/2" Brass | 1 13/16" | 27 lbs | |
| SJ100ANST | 100' x 1 1/2" Alum | 1 13/16" | 25 lbs | |
| SJ2550NST or NPSH | 50' x 2 1/2" Brass | 2 13/16" | 27 lbs | |
| SJ2550ANST | 50' x 2 1/2" Alum | 2 13/16" | 25 lbs | |
| SJ25100NST | 100' x 2 1/2" Brass | 2 13/16" | 51 lbs | |



SJ50NST



When you require an extra measure of certainty, our **UL LABELED SINGLE JACKET FIRE HOSE** fits the bill. Pre-tested under UL supervision, this premium fire hose features a proof test pressure of 500 psi and a service test of 250 psi. And in addition to fully rubber lined 100% polyester construction, every length carries the **UL®** mark, so you can be sure it's genuine. Brass couplings only.

NOTE: Recommended for industrial fire protection.

| P/N | DESCRIPTION | BOWL SIZE | WEIGHT COUPLED | EACH |
|-------------|---------------------|-----------|----------------|------|
| SJ50ULNST | 50' x 1 1/2" Brass | 1 13/16" | 15 lbs | |
| SJ75ULNST | 75' x 1 1/2" Brass | 1 13/16" | 20 lbs | |
| SJ100ULNST | 100' x 1 1/2" Brass | 1 13/16" | 27 lbs | |
| SJ2550ULNST | 50' x 2 1/2" Brass | 2 13/16" | 27 lbs | |



SJ50ULNST

For added durability under pressure, it's hard to beat our **DOUBLE JACKET FIRE HOSE**. Each length features two jackets of 100% polyester rubber-lined material for added protection against cuts, rips, and abrasion. It has a proof test pressure of 800 psi and a service test of 400 psi. Meets NFPA 1961.

NOTE: Recommended for industrial fire protection.

| P/N | DESCRIPTION | BOWL SIZE | WEIGHT COUPLED | EACH |
|-----------------|---------------------|-----------|----------------|------|
| DJ50NST or NPSH | 50' x 1 1/2" Brass | 1 15/16" | 20 lbs | |
| DJ50ANST | 50' x 1 1/2" Alum | 1 15/16" | 18 lbs | |
| DJ100NST | 100' x 1 1/2" Brass | 1 15/16" | 35 lbs | |
| DJ100ANST | 100' x 1 1/2" Alum | 1 15/16" | 32 lbs | |
| DJ2550NST | 50' x 2 1/2" Brass | 3" | 37 lbs | |
| DJ2550ANST | 50' x 2 1/2" Alum | 3" | 34 lbs | |

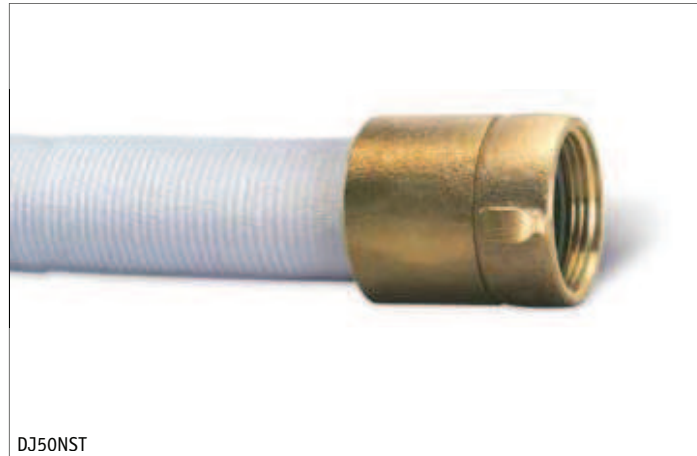

DJ50NST

For even more durability under pressure, our **YELLOW COATED FIRE HOSE** is a great choice. Constructed to the same specifications as our standard **Double Jacket Hose**, every section of **Coated Hose** is independently and completely impregnated with an abrasion-resistant, water-repellent polymer for outstanding performance under tough conditions. Aluminum couplings only.

NOTE: Recommended for industrial fire protection.

| P/N | DESCRIPTION | BOWL SIZE | WEIGHT COUPLED | EACH |
|---------------|-------------------|-----------|----------------|------|
| DJ50YHANST | 50' x 1 1/2" Alum | 1 15/16" | 21 lbs | |
| DJ17550YHANST | 50' x 1 3/4" Alum | 2 1/8" | 25 lbs | |
| DJ2550YHANST | 50' x 2 1/2" Alum | 3" | 39 lbs | |



DJ50YHANST

The ultimate hard wearing, hard performer, our **RUBBER COVERED FIRE HOSE** is the choice of professionals' nationwide. That's because it's abrasion-resistant, heat-free nitrile synthetic one-piece cover and liner is impervious to water, oil, gas, and most chemicals. It has a proof test pressure of 500 psi and a service test of 250 psi. Plus it's lightweight, virtually kink-resistant for easy handling, and never needs drying. Aluminum couplings only. Meets NFPA 1961.

| P/N | DESCRIPTION | BOWL SIZE | WEIGHT COUPLED | EACH |
|-------------|--------------------|-----------|----------------|------|
| RCH50ANST | 50' x 1 1/2" Alum | 1 3/4" | 11 1/2 lbs | |
| RCH100ANST | 100' x 1 1/2" Alum | 1 3/4" | 22 lbs | |
| RCH2550ANST | 50' x 2 1/2" Alum | 3" | 24 lbs | |



RCH50ANST

NOTE: For Additional Hose Options, Please Contact the Sales Department at 800.826.3473



3 FIRE HOSE, NOZZLES, BRASS, & HOSE VALVES



FH150ANST

This lightweight **FORESTRY HOSE** meets the USDA-US Forest Service Specification. Proof test pressure is 500 psi and service test is 250 psi. Aluminum couplings only.

| P/N | DESCRIPTION | BOWL SIZE | WEIGHT COUPLED | EACH |
|------------|------------------------|---------------------------------|----------------|------|
| FH150ANST | 50' x 1" Alum | 1 ¹ / ₄ " | 7 lbs | |
| FH1100ANST | 100' x 1" Alum | 1 ¹ / ₄ " | 11 lbs | |
| HS01 | Hose Tote Strap System | | | |

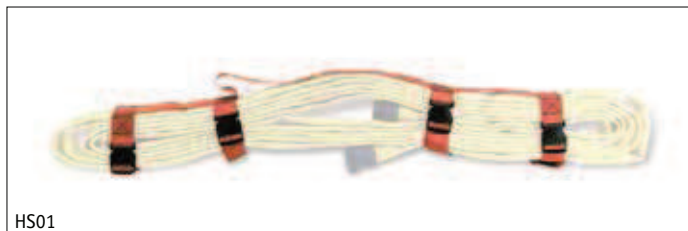

HS01

Designed for structural, vehicle, grass, and forestry firefighting, our **BOOSTER HOSE** has an outer jacket constructed from a specially compounded red neoprene (resists abrasion, ultraviolet light, ozone, and most petrochemicals) with two braids of high-tensile rayon yarn. The tube is constructed of smooth black SBR rubber for added performance. Hose has a proof test pressure of 1,600 psi and a service test of 800 psi. Aluminum couplings only. Meets NFPA 1961.

| P/N | DESCRIPTION | BOWL SIZE | WEIGHT COUPLED | EACH |
|------------|----------------|----------------------------------|----------------|------|
| BH150ANST | 50' x 1" Alum | 1 ⁹ / ₁₆ " | 31 lbs | |
| BH1100ANST | 100' x 1" Alum | 1 ⁹ / ₁₆ " | 60 lbs | |



BH150ANST

FIRE HOSE COUPLINGS, RINGS, AND GASKETS

RACK & REEL HOSE COUPLINGS are made of cast brass or aluminum and come with rings and gaskets.

| P/N | DESCRIPTION | BOWL SIZE | EACH |
|---------|--|-----------------------------------|------|
| RHCNST | 1 ¹ / ₂ " NST Brass | 1 ¹¹ / ₁₆ " | |
| ARHCNST | 1 ¹ / ₂ " NST Alum | 1 ¹¹ / ₁₆ " | |
| RHTG | Tail Gasket | 1 ¹¹ / ₁₆ " | |
| SJSG15 | 1 ¹ / ₂ " Swivel Hose Gasket | | |
| ER15 | 1 ¹ / ₂ " x ⁷ / ₈ " Expansion Ring | | |

SINGLE JACKET HOSE COUPLINGS are made of cast brass or aluminum and come with rings and gaskets.

| P/N | DESCRIPTION | BOWL SIZE | EACH |
|-------------|---|-----------------------------------|------|
| SJC15NST | 1 ¹ / ₂ " NST Brass | 1 ¹³ / ₁₆ " | |
| SJC15NPSHD | 1 ¹ / ₂ " NPSH Brass | 1 ¹³ / ₁₆ " | |
| ASJC15NST | 1 ¹ / ₂ " NST Alum | 1 ¹³ / ₁₆ " | |
| ASJC15NPSHD | 1 ¹ / ₂ " NPSH Alum | 1 ¹³ / ₁₆ " | |
| ASJC25NSTD | 2 ¹ / ₂ " NST Alum | 2 ¹³ / ₁₆ " | |
| SJC25NST | 2 ¹ / ₂ " NST Brass | 2 ¹³ / ₁₆ " | |
| SJTG15 | Tail Gasket | 1 ¹³ / ₁₆ " | |
| SJTG25 | Tail Gasket | 2 ¹³ / ₁₆ " | |
| SJSG15 | 1 ¹ / ₂ " Swivel Hose Gasket | | |
| SJSG25 | 2 ¹ / ₂ " Swivel Hose Gasket | | |
| SER15 | 1 ¹ / ₂ " x 1 ¹ / ₄ " Expansion Ring | | |
| SER25 | 2 ⁷ / ₁₆ " x 1 ¹ / ₄ " Expansion Ring | | |

DOUBLE JACKET HOSE COUPLINGS are made of cast brass or aluminum and come with rings and gaskets.

| P/N | DESCRIPTION | BOWL SIZE | EACH |
|------------|---|-----------------------------------|------|
| DJCNSTD | 1 ¹ / ₂ " NST Brass | 1 ¹⁵ / ₁₆ " | |
| DJCNPSHD | 1 ¹ / ₂ " NPSH Brass | 1 ¹⁵ / ₁₆ " | |
| ADJCNSTD | 1 ¹ / ₂ " NST Alum | 1 ¹⁵ / ₁₆ " | |
| DJC25NSTD | 2 ¹ / ₂ " NST Brass | 3" | |
| ADJC25NSTD | 2 ¹ / ₂ " NST Alum | 3" | |
| DJTG15 | Tail Gasket | 1 ¹⁵ / ₁₆ " | |
| DJTG25 | Tail Gasket | 3" | |
| SER15 | 1 ¹ / ₂ " x 1 ¹ / ₄ " Expansion Ring | | |
| DER25 | 2 ⁷ / ₁₆ " x 1 ¹ / ₂ " Expansion Ring | | |
| SJSG15 | 1 ¹ / ₂ " Swivel Hose Gasket | | |
| SJSG25 | 2 ¹ / ₂ " Swivel Hose Gasket | | |



RHCNST



GASKETS



SJC15NST



SER15, ER15



DJCNSTD



DER25



When you need to test hose, test it fast with one of our **SINGLE** or **TRIPLE ELECTRIC HOSE TESTERS**. Both accommodate 1½" and 2½" fire hoses and can be used in wet conditions with their 120V wash-down electric motors. Quick connect adapters are standard too. Can be used to meet NFPA Hose Testing Guidelines. Hose adapters sold separately, see page 45.

| P/N | DESCRIPTION | EACH |
|------------|-----------------------------|------|
| DDP59462GZ | Single Electric Hose Tester | |
| DDP58589GZ | Triple Electric Hose Tester | |
| DDP58524GZ | Cap, 1½" Hose Tester NST | |
| DDP58526GZ | Cap, 2½" Hose Tester NST | |
| DDP58585GZ | Plug, 1½" Hose Tester NST | |
| DDP58587GZ | Plug, 2½" Hose Tester NST | |



POLYCARBONATE FIRE HOSE NOZZLES

Brooks' high-impact **POLYCARBONATE NOZZLES** are an economical alternative to the more expensive brass models and come with the same array of spray patterns—straight stream to fog. Ideal for locations where brass theft is a concern.

NOTE: Intended for firefighting use only.

| P/N | UL RATING | EACH |
|--------|--|------|
| 15NST | UL Listed for Class A:B Fires Only | |
| 15IPT | UL Listed for Class A:B Fires Only | |
| E15IPT | UL Listed for Class A:B:C (Electrical) Fires | |
| E15NST | UL Listed for Class A:B:C (Electrical) Fires | |

| P/N | DESCRIPTION | EACH |
|---------|---|------|
| 10NST | 1" Adjustable Fog/Stream/Shut-Off, 30 gpm, NST | |
| 10IPT | 1" Adjustable Fog/Stream/Shut-Off, 30 gpm, NPSH | |
| 15NST | 1½" Adjustable Fog/Stream/Shut-Off, 78 gpm, NST | |
| 15IPT | 1½" Adjustable Fog/Stream/Shut-Off, 78 gpm, NPSH | |
| E15IPT | 1½" Adjustable Fog/Shut-Off Only, 78 gpm, NPSH | |
| E15NST | 1½" Adjustable Fog/Shut-Off Only, 78 gpm, NST | |
| 25NST | 2½" Adjustable Fog/Stream/Shut-Off, 210 gpm, NST | |
| 2520NST | 2½" Adjustable Fog/Stream/Shut-Off w/ Handles, 150 gpm, NST | |
| B250G | Nozzle Gasket for 2½" Nozzles | |
| GIPT | Nozzle Gasket for 1½" NPSH Nozzles | |
| GNST | Nozzle Gasket for 1½" NST Nozzles | |
| 10G | Gasket for 1" NST Nozzles | |

Rated gallons per minute (gpm) at 100 psi (wide open).



BRASS FIRE HOSE NOZZLES

Made just like they were in the old days, these **Underwriter PLAYPIPES** are constructed of cast brass with red Marlin trim and a swivel handle. The discharge end is supplied with **Underwriter's** thread (2³/₁₆" ODM x 12 threads per inch) and the whole pipe is 30" long. Inlet: 2½" NST with a standard 1¼" discharge tip (1¾" without tip).

| P/N | DESCRIPTION | EACH |
|-----|-------------|------|
| 221 | Playpipe | |



Our **BRASS STRAIGHT STREAM NOZZLE** comes with a ½" discharge at the tip for powerful sprays that reach a long way, making this 1½" x 10" nozzle ideal for industrial wash down. Satin brass finish.

| P/N | DESCRIPTION | EACH |
|------|------------------------------|------|
| 211N | Straight Stream Nozzle (NST) | |



3 FIRE HOSE, NOZZLES, BRASS, & HOSE VALVES



These industrial-grade **BRASS FOG NOZZLES** are precision machined to perform flawlessly—straight stream through full fog and shutoff. Satin brass finish. UL listed for Class A and B fires and FM approved, except 114N (UL listed only).

| P/N | DESCRIPTION | EACH |
|------|---|------|
| 117N | 1 1/2" Adjustable Fog Nozzle, 94 gpm, NST | |
| 117I | 1 1/2" Adjustable Fog Nozzle, 94 gpm, NPSH | |
| 114N | 2 1/2" Adjustable Fog Nozzle, 270 gpm, NST | |
| 113N | 1 1/2" Adjustable Fog Nozzle, 106 gpm, NST | |
| 113I | 1 1/2" Adjustable Fog Nozzle, 106 gpm, NPSH | |
| 118N | 1" Adjustable Fog Nozzle, 26 gpm, NST | |
| 118I | 1" Adjustable Fog Nozzle, 26 gpm, NPSH | |



Designed specifically for electrical fires (no straight stream), these industrial **BRASS ALL-FOG NOZZLES** are precision machined for optimum performance from shut off to 30° through 90° fog. Satin brass finish. UL listed for Class A, B, and C (Electrical) fires.

| P/N | DESCRIPTION | EACH |
|------|------------------------------------|------|
| 115N | 1 1/2" All-Fog Nozzle, 98 gpm, NST | |

BRASS PIN RACK NOZZLES are made to clip into any standard hose rack unit, providing easy, economical protection at the business end of the fire hose. Nozzles come standard with variable streams (shut off, straight stream, and fog). Satin brass finish. UL listed for Class A and B fires.

| P/N | DESCRIPTION | EACH |
|------|---|------|
| 116N | 1 1/2" Adjustable Rack Fog Nozzle, 60 gpm, NST | |
| 116I | 1 1/2" Adjustable Rack Fog Nozzle, 60 gpm, NPSH | |

UL rated gallons per minute (gpm) at 100 psi (wide open)



RACKS AND REELS

Brooks semi-automatic **PIN RACKS** offer all the quality and performance you need for a hanging rack and single jacket hose. Each one comes pre-loaded with movable pins and an automatic release mechanism that keeps water out of the hose until the last fold is removed. Red.

NOTE: Pin rack length is measured from center of nipple opening to end of hose clip.

| P/N | RACK HOSE | SJ HOSE | HOSE DIA | L | W |
|---------|-----------|---------|----------|---------|--------|
| DMHR4UL | 100' | — | 1 1/2" | 18" | 4" |
| HR4FMUL | 100' | — | 1 1/2" | 17 1/2" | 4 1/4" |
| HR5SJ | — | 100' | 1 1/2" | 22" | 4" |
| HR6FMUL | 100' | — | 1 1/2" | 17 1/2" | 4 1/4" |

| P/N | DESCRIPTION | EACH |
|---------|---|------|
| DMHR4UL | Pin Rack for Rack Hose, UL | |
| HR4FMUL | Pin Rack for Rack Hose, UL/FM | |
| HR5SJ | Pin Rack for SJ Hose | |
| HR6FMUL | Pin Rack w/ 2 1/2" Nipple Opening for Rack Hose, UL | |

PIN RACK ACCESSORIES include wall brackets, rack nipples, nozzle clips, and extra pins for supporting and maintaining hose rack assemblies. Use a wall bracket with a F x M valve and a rack nipple with a F x F valve.

| P/N | DESCRIPTION | EACH |
|------|---|------|
| FHWB | Wall Bracket for Pin Rack w/ 1 1/2" Opening | |
| 311I | 1 1/2" Rack Nipple, NPT x NPSH | |
| 311N | 1 1/2" Rack Nipple, NPT x NST | |
| 312N | 2 1/2" Rack Nipple, NPT x NST | |

| P/N | DESCRIPTION | EACH |
|------|-----------------------------------|------|
| FOGC | Fog Nozzle Clip for Pin Rack | |
| RPIN | Pin for Badger Powhatan Pin Rack | |
| BPIN | Pin for Brooks & Elkhart Pin Rack | |



Accommodates Up To 100' Of 2½" Fire Hose

These **FireTech™ HOSE HANGERS** are constructed of aluminum alloy and conveniently accommodate 100' of lined or unlined hose, up to 2½". The top shoulder is spring loaded so that water pressure or a single pull is sufficient to release the hose. It also stores hose close to walls or columns to minimize damage as well as allowing for fewer bends in the hose, prolonging its life. Mounting instructions included.

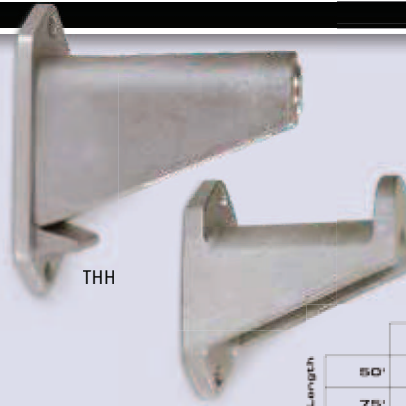

P/N **DESCRIPTION** **EACH**
 THH Hose Hanger

| Hose Length | Total Loops Of Hose | | |
|-------------|---------------------|----|----|
| | 2 | 3 | 4 |
| 50' | 12 | 8 | 6 |
| 75' | | 12 | 8 |
| 100' | | | 12 |

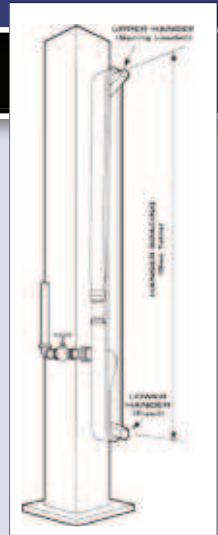

Brooks' steel **ECONOMY HOSE REELS** offer quality and value in a sturdy design. They come with a 16-gauge steel wall bracket that swings 180°. Red baked enamel finish.

| P/N | RACK HOSE | SJ HOSE | DJ HOSE | HOSE DIA | L | H | W |
|-------|-----------|---------|---------|----------|------|-----|-----|
| FHR | 100' | 75' | — | 1½" | 23½" | 18" | 6½" |
| FHR24 | 150' | 100' | — | 1½" | 29" | 24" | 6¼" |

P/N **DESCRIPTION** **EACH**
 FHR 18" Economy Hose Reel
 FHR24 24" Economy Hose Reel



FHR

Offering some serious storage for your fire hose, **Brooks'** **HEAVY-DUTY HOSE REELS** feature solid 16-gauge steel sides and hubs. The mounting hardware is tough, too, featuring a welded steel 1" x ¾" reel bracket with a 1½" x ¼" steel wall bracket for impressive support. The wall bracket swings 180° and easily adapts to pipes (1½"—3") with optional pipe bracket set **PBSET**. Each reel comes with a hook-and-loop back strap to keep hose securely wound. Red baked enamel finish.

| P/N | RACK HOSE | SJ HOSE | DJ HOSE | HOSE DIA | L | H | W |
|---------|-----------|---------|---------|----------|------|-----|-----|
| HDR19 | 100' | 75' | 50' | 1½" | 23¾" | 19" | 5¾" |
| HDR25 | 150' | 100' | 75' | 1½" | 30" | 25" | 5¾" |
| HDR25HC | 300' | 200' | 150' | 1½" | 30" | 25" | 8¾" |
| HDR25HC | 150' | 100' | 75' | 2½" | 30" | 25" | 8¾" |

P/N **DESCRIPTION** **EACH**
 HDR19 19" Heavy-Duty Hose Reel
 HDR25 25" Heavy-Duty Hose Reel
 HDR25HC 25" High-Capacity, Heavy-Duty Hose Reel



HDR19

P/N **DESCRIPTION** **EACH**
 PBSET Pipe Brackets for Heavy-Duty Reels, Pkg/2
 VBSBK Black Velcro Strap

Increase the service life of your hose with our red enameled steel **HUMP RACKS**. They provide easy, stress-free fire hose storage by supporting the hose weight at its center, relieving strain on the folded ends and couplings.

| P/N | RACK HOSE | SJ HOSE | DJ HOSE | HOSE DIA | L | H | W |
|------|-----------|---------|---------|----------|------|------|-----|
| HHR1 | 200' | 100' | 75' | 1½" | 33½" | 27⅞" | 4⅜" |
| HHR2 | 200' | 100' | 75' | 2½" | 33½" | 27⅞" | 5⅓" |

P/N **DESCRIPTION** **EACH**
 HHR1 Hump Rack for 1½" Hose
 HHR2 Hump Rack for 2½" Hose



HHR1



3 FIRE HOSE, NOZZLES, BRASS, & HOSE VALVES



RC25



RC25LS



HRC1



FHRC18



HH1



STW



W570



W580



W575



K48



AFS



RQR



RST1

Brooks' RACK COVERS are made of durable vinyl to protect your hose rack assemblies from dirt and grime. They're highly visible and that helps discourage tampering. Hook-and-loop closures ensure a proper fit and easy access in an emergency.

| P/N | DESCRIPTION | L X H X W | EACH |
|--------|-------------------------------------|------------------|------|
| RC25 | Cover for Pin Rack, Red | 21" x 24" x 5" | |
| RC25S | Cover for Pin Rack, Orange, Spanish | 21" x 24" x 5" | |
| RC25L | Cover for Pin Rack, Red | 21" x 30" x 5" | |
| RC25LS | Cover for Pin Rack, Orange, Spanish | 25" x 24" x 5" | |
| RC32 | Cover for Pin Rack, Red | 25" x 24" x 5" | |
| HRC1 | Cover for HHR1 Hump Rack, Red | 34" x 28½" x 5" | |
| HRC2 | Cover for HHR2 Hump Rack, Red | 34" x 28½" x 6¼" | |

Brooks' REEL COVERS are manufactured to the same standards as our rack covers, offering a custom fit for both our **Economy** and **Heavy-Duty Hose Reels**. These durable vinyl covers are a must for protecting a hose reel investment. Red.

| P/N | DESCRIPTION | EACH |
|----------|---|------|
| FHRC18 | Cover for FHR & HDR19 Hose Reels, 20"L x 19"H x 5"W | |
| FHRC24 | Cover for FHR24 & HDR25 Hose Reels, 26"L x 25"H x 5"W | |
| FHRC24DW | Cover for HDR25HC Hose Reel, 26"L x 25"H x 8"W | |

MUNICIPAL HAND TOOLS

Our **HOSE HOOK** is a multi-purpose tool that carries hose rolls (up to 5" in diameter) and pulls double duty as a wrench for pin and rocker lugs (up to 2½") as well as 4" and 5" storz fittings. It also opens foam bucket lids, drains hose, and holds doors open. It comes with a mounting bracket to help keep it handy too.

| P/N | DESCRIPTION | EACH |
|-----|-------------|------|
| HH1 | Hose Hook | |

Designed for today's fire department connections, this assortment of quality **WRENCHES** cover all the popular sizes and styles in storz and threaded adapters (pin or rocker lugs).

| P/N | DESCRIPTION | EACH |
|------|---|------|
| STW | Storz x Universal Spanner (Alum) Fits 4"-6" Storz & 1½"-3" Rocker Lugs | |
| STH | Storz Spanner Wrench Holder (Holder Only) | |
| W570 | Universal Spanner Wrench (Alum) Fits 1½"-3" Pin/Rocker Lugs | |
| W580 | Standard Hydrant/Spanner Wrench (Steel/Ductile Iron) Fits 1½"-6" Pin/Rocker Lugs | |
| W575 | Heavy-Duty Hydrant/Spanner Wrench (Steel/Ductile Iron) Fits 1½"-6" Pin/Rocker Lugs | |
| K48 | Hydrant/Spanner Wrench Holder (Holder Only) | |
| AFS | Folding Pocket Spanner Wrench (Plastic) Fits Pin/Rocker Lugs Thru 4" | |

This collection of **MULTI-PURPOSE RESCUE TOOLS** features the **Res-Q-Rench** that's five tools in one—universal spanner, pry tool, window punch, seat belt cutter, and gas shutoff. The small but effective **Res-Q-Me** tool easily shatters tempered glass and cuts through safety belts in seconds. A must-have for service techs and first responders alike.

| P/N | DESCRIPTION | EACH |
|------|--|------|
| RQR | Res-Q-Rench Fits 4", 5" Storz & Rocker Lugs thru 3" | |
| RST1 | Res-Q-Me Tool | |



FIRE AXES and **ACCESSORIES** include some of the finest emergency entry tools available today. The discriminating professional has a choice of four different axes—with or without pick heads (all with 6 lb heads) and either solid hickory or yellow fiberglass handles. Optional mounting bracket and hooks sold separately.

| P/N | DESCRIPTION | EACH |
|-------|---|------|
| 406M* | Pick Head Fire Axe w/ 36" Hickory Handle | |
| 406Y* | Pick Head Fire Axe w/ 30 ³ / ₄ " Fiberglass Handle | |
| 407Y* | Flat Head Fire Axe w/ 34" Fiberglass Handle | |
| D406M | Pick Head Fire Axe w/ 32 ¹ / ₄ " Hickory Handle (Domestic) | |
| D406Y | Pick Head Fire Axe w/ 32 ³ / ₄ " Fiberglass Handle (Domestic) | |
| D407Y | Flat Head Fire Axe w/ 33" Fiberglass Handle (Domestic) | |
| AB408 | Axe Bracket & Hook | |

*WHILE QUANTITIES LAST.

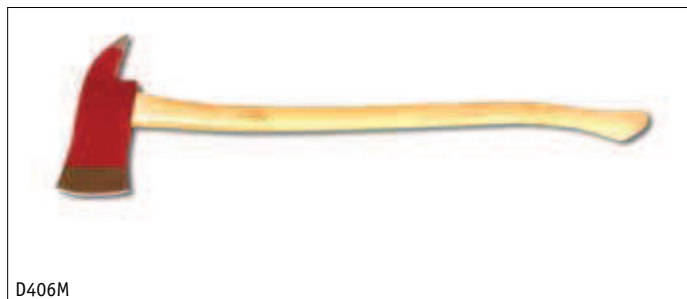

D406M

ADAPTERS, CAPS, AND PLUGS

Female x Male **BRASS HEXAGON ADAPTERS** are used to change threads. Rigid hexagon design in cast brass.

| P/N | DESCRIPTION | EACH |
|-----|--|------|
| 711 | 1 ¹ / ₂ " PCT(F) x 1 ¹ / ₂ " NST(M) | |
| 712 | 1 ¹ / ₂ " NPT(F) x 1 ¹ / ₂ " NST(M) | |
| 713 | 1 ¹ / ₂ " NST(F) x 1 ¹ / ₂ " NPT(M) | |
| 714 | 1 ¹ / ₂ " NPSH(F) x 1 ¹ / ₂ " NST(M) | |
| 715 | 2 ¹ / ₂ " NPT(F) x 2 ¹ / ₂ " NST(M) | |
| 716 | 2 ¹ / ₂ " NST(F) x 2 ¹ / ₂ " NPT(M) | |



AB408

Female x Male **BRASS REDUCERS** are used to change threads or size. Pin lug design in cast brass.

| P/N | DESCRIPTION | EACH |
|-----|--|------|
| 721 | 2 ¹ / ₂ " NST(F) x 1 ¹ / ₂ " NST(M) | |
| 722 | 2 ¹ / ₂ " NPSH(F) x 1 ¹ / ₂ " NST(M) | |
| 724 | 2 ¹ / ₂ " NST(F) x 3/4" GHT(M) | |
| 725 | 2 ¹ / ₂ " NST(F) x 1 ¹ / ₂ " NPSH(M) | |
| 726 | 1 ¹ / ₂ " NST(F) x 3/4" GHT(M) | |
| 727 | 1 ¹ / ₂ " NST(F) x 1" NST(M) | |



711

Male x Male **BRASS HEXAGON NIPPLES** are used to change configuration, threads, or size. Rigid hexagon design in cast brass.

| P/N | DESCRIPTION | EACH |
|-----|---|------|
| 731 | 1 ¹ / ₂ " NPT(M) x 1 ¹ / ₂ " NST(M) | |
| 732 | 2 ¹ / ₂ " NPT(M) x 2 ¹ / ₂ " NST(M) | |
| 733 | 2 ¹ / ₂ " NPT(M) x 1 ¹ / ₂ " NST(M) | |



721

Female x Female **BRASS DOUBLE SWIVEL ADAPTERS** are used to connect two male hose threads. Dual pin lug swivel design in cast brass. Made in the US.

| P/N | DESCRIPTION | EACH |
|------|---|------|
| B741 | 1 ¹ / ₂ " NST(F) x 1 ¹ / ₂ " NST(F) | |
| B742 | 2 ¹ / ₂ " NST(F) x 2 ¹ / ₂ " NST(F) | |



731

B741

Female x Male **BRASS HEXAGON BUSHINGS** are used to change threads or size. Rigid hexagon design in cast brass.

| P/N | DESCRIPTION | EACH |
|-----|---|------|
| 751 | 2" NPT(F) x 2 ¹ / ₂ " NST(M) | |
| 752 | 1 ¹ / ₂ " NST(F) x 2 ¹ / ₂ " NST(M) | |
| 753 | 1 ¹ / ₂ " NST(F) x 2 ¹ / ₂ " NPT(M) | |



752



3 FIRE HOSE, NOZZLES, BRASS, & HOSE VALVES



Female x Female **BRASS HEXAGON ADAPTERS** are used to change threads or connect two males. Rigid hexagon design in cast brass.

| P/N | DESCRIPTION | EACH |
|-----|-------------------------------|------|
| 761 | 2 1/2" NST(F) x 2 1/2" NPT(F) | |
| 762 | 1 1/2" NST(F) x 1 1/2" NPT(F) | |
| 763 | 1 1/2" NST(F) x 1 1/2" NST(F) | |

761



Female x Female **BRASS SNOOTS** are used to connect to flush inlet connections. Rigid hexagon design with pin lug swivel in cast, polished, or chrome-plated brass.

| P/N | DESCRIPTION | EACH |
|-------|---|------|
| 811 | 2 1/2" NPT(F) x 2 1/2" NST(F), Cast | |
| 811PB | 2 1/2" NPT(F) x 2 1/2" NST(F), Polished | |
| 811PC | 2 1/2" NPT(F) x 2 1/2" NST(F), Chrome | |

811PB



Female x Male **BRASS SNOOTS** are used to connect to flush hydrant connections. Rigid hexagon design with pin lug swivel in cast brass.

| P/N | DESCRIPTION | EACH |
|-----|-------------------------------|------|
| 821 | 2 1/2" NST(F) x 2 1/2" NPT(M) | |
| 822 | 1 1/2" NST(F) x 1 1/2" NPT(M) | |

822



BRASS CAPS & CHAINS are used on fire department connections, hydrants, valves, etc., to hold back water. Pin lug design in cast, polished, or chrome-plated brass.

| P/N | DESCRIPTION | EACH |
|----------|---------------------------------|------|
| 511I | 1 1/2" NPSH, Cast | |
| 511N | 1 1/2" NST, Cast | |
| 511NPB | 1 1/2" NST, Polished | |
| 511NPC | 1 1/2" NST, Chrome | |
| 512N | 2 1/2" NST, Cast | |
| B512N | 2 1/2" NST, Cast, Domestic | |
| 512NPB | 2 1/2" NST, Polished | |
| 512NPC | 2 1/2" NST, Chrome | |
| 512NPCRL | 2 1/2" NST, Chrome (Rocker Lug) | |

511N



BRASS PLUGS & CHAINS are used on fire department inlet connections to keep inlet ports free of debris. Pin lug design in cast, polished, or chrome-plated brass.

| P/N | DESCRIPTION | EACH |
|----------|---------------------------------|------|
| 513N | 2 1/2" NST, Cast | |
| B513N | 2 1/2" NST, Cast, Domestic | |
| 513NPB | 2 1/2" NST, Polished | |
| 513NPC | 2 1/2" NST, Chrome | |
| 513NPCRL | 2 1/2" NST, Chrome (Rocker Lug) | |
| 514N | 1 1/2" NST, Cast | |

512N



514N, 513N



PLASTIC CAPS & CHAINS are an inexpensive way to protect hydrant threads and a viable replacement for brass caps when theft is an issue. Models **B150** and **B250** thread on, while the **U250** pushes/pulls on and off. Red.

| P/N | DESCRIPTION | EACH |
|---------|------------------|------|
| B150IPT | 1 1/2" NPSH | |
| B150NST | 1 1/2" NST | |
| B250 | 2 1/2" NST | |
| U250 | 2 1/2" Universal | |
| B250G | Gasket for B250 | |

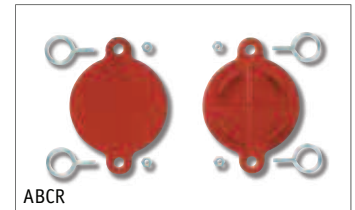
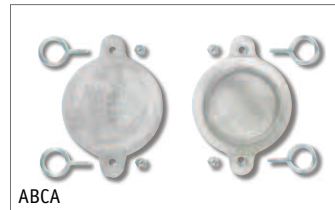
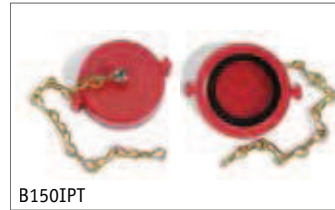

Our **ALUMINUM BREAK CAPS** serve the same function as the brass and plastic caps, but instead of screwing or pushing/pulling on and off, they are easily broken with a hydrant/spanner wrench. Caps attach to inlets courtesy of two eye bolts that slip over pin lugs.

| P/N | DESCRIPTION | EACH |
|------|-----------------------|------|
| ABCA | 2 1/2", Silver, Pkg/2 | |
| ABCR | 2 1/2", Red, Pkg/2 | |



The most economical way to protect fire dept. connection inlets is with **PLASTIC BREAK CAPS**. Choose either the **PAC**, which uses an adjustable bar that threads onto any hose thread or the **PBC2**, which uses eye bolts to secure the cap via the inlet's pin lugs. Both fit 2 1/2" inlets and are easily broken with a hydrant/spanner wrench. Red.

| P/N | DESCRIPTION | EACH |
|------|---------------------------------------|------|
| PAC | Adjust-A-Plug | |
| PBC2 | Plastic Break Cap w/ Eye Bolts, Pkg/2 | |



HOSE VALVES

These precision-made **GATED WYE LEADER LINE SIAMESE** come with ball valves built into the body so that either lead can be used independently of the other. **Gated Wyes** feature 2 1/2" NST female swivel inlets and 1 1/2" male outlets in two different threads. Other features include a cast brass body, painted red with polished-chrome trim and rocker lug swivels.

NOTE: Not recommended for charged pre-connected hose lines!

| P/N | DESCRIPTION | EACH |
|---------|---------------------------|------|
| 611 | Gated Wye, NST (Outlets) | |
| 611NPSH | Gated Wye, NPSH (Outlets) | |



Engineered for trouble-free operation, these **ANGLE HOSE VALVES** are designed for use with hose storage devices and hydrants. Each valve has a 300 lb rating and is UL listed and FM approved. Constructed of cast brass with red or silver handwheels.

| P/N | DESCRIPTION | EACH |
|------|---|------|
| 411 | 1 1/2" NPT(F) x 1 1/2" NPT(F) Valve, Red | |
| B411 | 1 1/2" NPT(F) x 1 1/2" NPT(F) Valve, Silver | |
| 412 | 2 1/2" NPT(F) x 2 1/2" NPT(F) Valve, Red | |
| 413 | 1 1/2" NPT(F) x 1 1/2" NST(M) Valve, Red | |
| B413 | 1 1/2" NPT(F) x 1 1/2" NST(M) Valve, Silver | |
| 414 | 2 1/2" NPT(F) x 2 1/2" NST(M) Valve, Red | |
| B414 | 2 1/2" NPT(F) x 2 1/2" NST(M) Valve, Silver | |
| 415 | 1 1/2" NPT(F) x 1 1/2" NPSH(M) Valve, Red | |



3 FIRE HOSE, NOZZLES, BRASS, & HOSE VALVES

Some of the finest **PRESSURE REDUCING ANGLE HOSE VALVES** you'll find in the industry. Can be adjusted to restrict pressures up to 175 lbs and come with locking pin devices that restrict full opening by untrained personnel. Pin may be removed by fire personnel for unrestricted operation in emergencies. UL listed. Cast brass construction with red handwheels.

| P/N | DESCRIPTION | EACH |
|-----|-------------------------------------|------|
| 421 | 1 1/2" NPT(F) x 1 1/2" NPT(F) Valve | |
| 422 | 2 1/2" NPT(F) x 2 1/2" NPT(F) Valve | |
| 423 | 1 1/2" NPT(F) x 1 1/2" NST(M) Valve | |
| 424 | 2 1/2" NPT(F) x 2 1/2" NST(M) Valve | |

Heavy-duty **GATE VALVES**, from **Brooks**, are designed for use on pump test headers and dry systems as a fire hose connection. Valves feature a straightway pattern and come with caps and chains. Other features include solid wedge discs with tapered seats and a 300 lb rating. UL listed and FM approved. Cast brass construction with red handwheels.

| P/N | DESCRIPTION | EACH |
|-----|--|------|
| 433 | 2 1/2" NPT(F) x 2 1/2" NST(M) Valve | |
| 434 | 3" NPT(F) x 2 1/2" NST(M) Valve, Rising Stem | |

SINGLE HYDRANT GATE VALVES are used on fire hydrant outlets for a slow and precise control of flow (throttling). Solid brass valves feature metal-to-metal seats and non-rising stems with an aluminum crank handle or red handwheel. They come standard in a straightway pattern and with a 300 lb rating.

| P/N | DESCRIPTION | EACH |
|------|---|------|
| 443 | 2 1/2" NST(F) x 2 1/2" NST(M) Gate Valve w/ Swivel | |
| B443 | 2 1/2" NST(F) x 2 1/2" NST(M) Valve w/ Swivel, Domestic | |

VALVE REPLACEMENT PARTS. Red handwheels fit **Giacomini** valves; silver handwheels fit **Powhatan**.

| P/N | DESCRIPTION | EACH |
|--------|--|------|
| PHW15 | Handwheel for Powhatan 1 1/2" Valve | |
| PHWN15 | Handwheel Nut for Powhatan 1 1/2" Valve | |
| GHW15 | Handwheel for Giacomini 1 1/2" Valve | |
| PHW25 | Handwheel for Powhatan 2 1/2" Valve | |
| PHWN25 | Handwheel Nut for Powhatan 2 1/2" Valve | |
| GHW25 | Handwheel for Giacomini 2 1/2" Valve | |
| GHWN | Handwheel Nut for Giacomini Valve | |
| GSRS15 | Rubber Seal for Giacomini 1 1/2" Angle Valve | |
| PSRS15 | Rubber Seal for Powhatan 1 1/2" Angle Valve | |
| PSRS25 | Rubber Seal for Powhatan 2 1/2" Angle Valve | |



REPLACEMENT PARTS



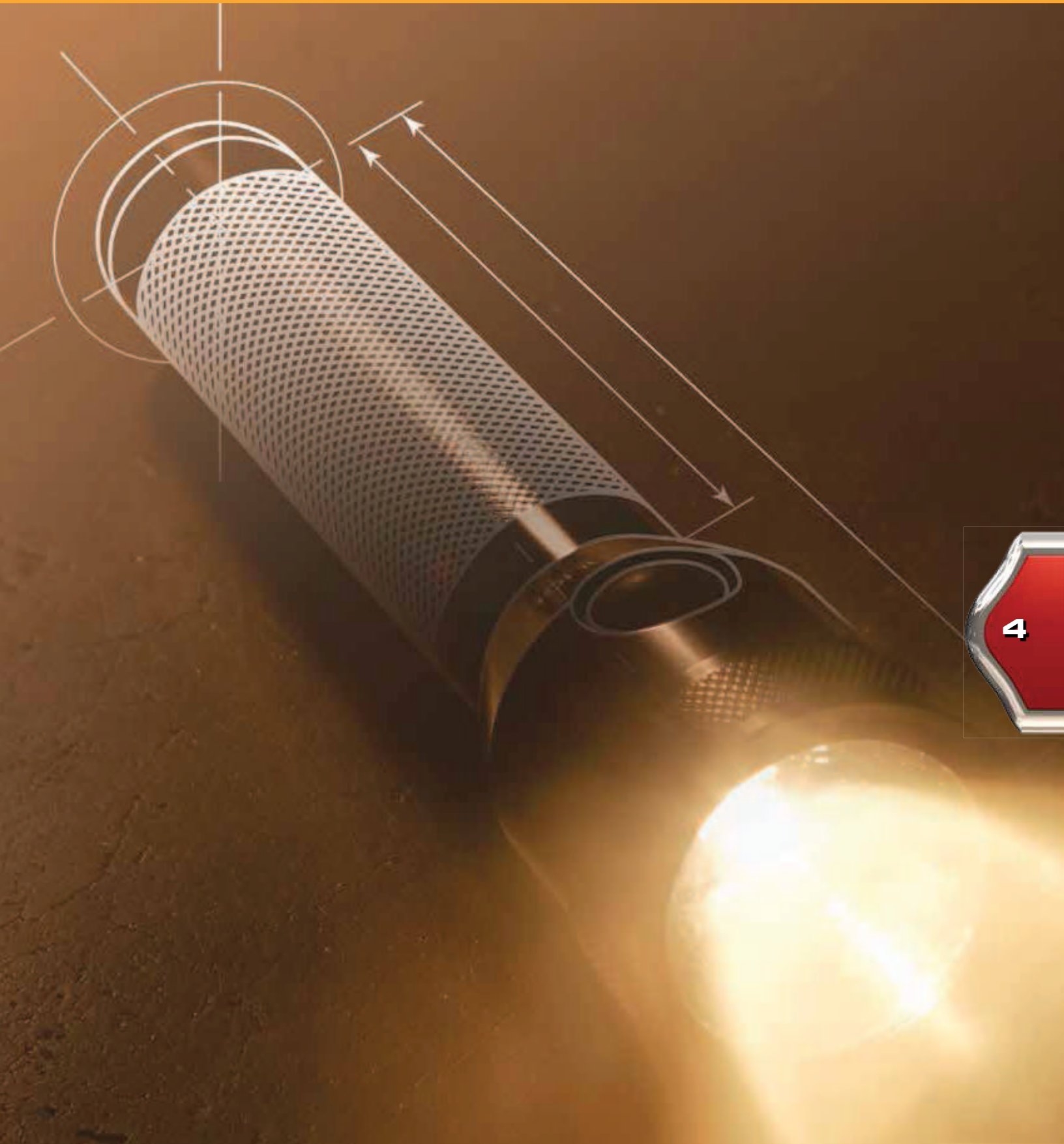

*Locations: Optimized for
delivery you can trust.*



2500L

Now those who work emergency, rescue, construction, and other extreme jobs have one less thing to worry about—their hands. With the help of **Kevlar®** and **Armortex®**, the **ProFlex® FIRE & RESCUE PERFORMANCE GLOVES**, from **Ergodyne®**, can be used for extrication rescues and other jobs that push the limits of endurance. Plus they're PVC-reinforced at the fingertip gripping zones to retain a tighter hold, while EVA padding cuts down on shock and impact to the hands. Stretch spandex shell makes for a comfortable fit. Lime/Black.

| P/N | DESCRIPTION | SIZE | EACH |
|--------|----------------------------------|------|------|
| 2500M | Performance Fire & Rescue Gloves | M | |
| 2500L | Performance Fire & Rescue Gloves | L | |
| 2500XL | Performance Fire & Rescue Gloves | XL | |



5228GFDP

PROTECTIVE GEAR

These premium **STRUCTURAL FIREFIGHTING GLOVES**, from **Shelby®**, are made from heavy-weight, fire-retardant, and heat-resistant midnight blue **Koala®** tanned cowhide for maximum performance under any conditions. They're also sewn with **Kevlar®** thread to hold things together. Inside, there's a fleece liner as well as **Gore** glove barrier fabric to keep things thermally stable. A gunn cut pattern with a wing thumb and wraparound index finger is standard too. Plus every pair features **Shelby FDP™** ("Fit + Durability = Performance"). Meets NFPA 1971–2013 standards.

| P/N | DESCRIPTION | SIZE | EACH |
|-------------|---|------|------|
| 5228GFDP S | Structural Firefighting Gloves w/ Gauntlets | S | |
| 5228GFDP M | Structural Firefighting Gloves w/ Gauntlets | M | |
| 5228GFDP L | Structural Firefighting Gloves w/ Gauntlets | L | |
| 5228GFDP XL | Structural Firefighting Gloves w/ Gauntlets | XL | |



5009XL

For quality, and economy, try **Shelby® STRUCTURAL FIREFIGHTING GLOVES**. They're made from wash-and-wear tan pigskin for extra toughness. And they're gunn cut with seamless palms, wing thumbs, and come with **Nomex®** wristlets for extra flame resistance. Meets CAL and Federal OSHA requirements.

| P/N | DESCRIPTION | SIZE | EACH |
|--------|--------------------------------|------|------|
| 5009S | Structural Firefighting Gloves | S | |
| 5009M | Structural Firefighting Gloves | M | |
| 5009L | Structural Firefighting Gloves | L | |
| 5009XL | Structural Firefighting Gloves | XL | |



PSV1

Be ready for any low-light situation with **Ergodyne's** hi-vis **GloWear® PUBLIC SAFETY VESTS**. These vests feature a two-tone, five-point breakaway design with Level 2 ANSI-certified tape set on a 4½" contrasting color background. There is one multi-division pocket on the inside and radio tabs/holders. Used for operations at local, state, and federal levels, **GloWear** safety vests help quickly identify people working in emergency response. ANSI 207-2011 compliant. Lime.

| P/N | DESCRIPTION | SIZE | EACH |
|------|----------------------------|---------|------|
| PSV1 | 8245PSV Public Safety Vest | L–XL | |
| PSV2 | 8245PSV Public Safety Vest | 2XL–3XL | |
| PSV3 | 8245PSV Public Safety Vest | 4XL–5XL | |



Firefighters' Top Pick

The **Cobra™ Classic™ FIREFIGHTING HOOD**, from **PGI**, is the top pick by firefighting professionals because it offers serious protection without sacrificing comfort. The hood accomplishes this by blending **Nomex®/Lenzing FR®** for superior flame and heat resistance with a **Comfort-Plus®** liner for unbeatable breathability, comfort, and moisture wicking properties. Flat stitched seams won't bunch or dig into your skin either. There's also an extra-heavyweight elastic face opening that stretches to a full 16" for easy donning and a snug fit—with or without an **SCBA** mask. Coverage extends to lower neck. UL classified to NFPA 1971. One size. White.

| P/N | DESCRIPTION | EACH |
|------|-------------------|------|
| BZ33 | Firefighting Hood | |



From **Bullard®**, one of the biggest names in **FIREFIGHTING HELMETS**, comes the **Firedome®**—life saving thermoplastic head protection for optimum impact and penetration resistance. They're very reliable under repeated heat exposure, and every helmet comes standard with the **Sure-Lock®** ratchet headband suspension for easy adjustment and superior comfort. Optically correct face shields are standard as well. Yellow. Certified to NFPA 1971 Standard on Protective Ensembles for Structural Fire Fighting, 2013 Edition.

| P/N | DESCRIPTION | EACH |
|-----|---------------------------|------|
| PXY | Thermoplastic Fire Helmet | |



StrikeTeam XTO™ GOGGLES are designed with wildland firefighting and technical rescue operations in mind, but they are an ideal choice for numerous other situations requiring dependable eye protection. They come with tons of premium features, too—**Speed-Clip™** quick strap adjustment, face padding, and replaceable lenses with tear-off covers. And speaking of lenses, they're virtually indestructible, thanks to polycarbonate construction. They're also fog-free with full-filter ventilation. Goggles will fit over most eyeglasses and are ANSI Z87.1+ and NFPA 1500–2007 compliant.

| P/N | DESCRIPTION | EACH |
|------|-------------------------|------|
| ESS1 | Black Frame, Clear Lens | |



New, Lower Price!



LBB10

Black Diamond® RUBBER FIRE BOOTS offer incredible comfort with stitched-down linings that don't pull out. And with their non-slip heels, they offer a better, more accurate fit, because the foot remains in place while working and walking. Plus the midsoles are coated with 9.5mm felt, which takes it easy on the feet. Other standard features include steel toes and shanks for added protection and lug outsoles for a better purchase on all types of terrain. Boots are also open cell foam insulated and meet or exceed NFPA 1971, ANSI Z41, and CSA Z195 requirements.

| P/N | DESCRIPTION | SIZE | EACH |
|-------|---------------------|-----------|------|
| LBB8 | 16" Insulated Boots | 8 Medium | |
| LBB9 | 16" Insulated Boots | 9 Medium | |
| LBB10 | 16" Insulated Boots | 10 Medium | |
| LBB11 | 16" Insulated Boots | 11 Medium | |
| LBB12 | 16" Insulated Boots | 12 Medium | |
| LBB13 | 16" Insulated Boots | 13 Medium | |
| LBB14 | 16" Insulated Boots | 14 Medium | |



HBS



LGB

ACCESSORIES

| P/N | DESCRIPTION | EACH |
|-----|---|------|
| HBS | Fully Adjustable, Red "H" Back Suspenders | |
| LGB | Firefighter's Gear Bag, Coated 1,000-Denier Nylon, 27"L x 18"H x 12"W | |



SL72001

PUBLIC SAFETY LIGHTING

Streamlight's KEY-MATE® is big on power (10 lumens), thanks to its high-intensity LED that lasts 100,000 hours. Its anodized-aluminum casing is virtually indestructible. Four high-capacity alkaline button cell batteries (included) power it for up to 96 hours. Measures 2⁵/₁₆". Black.

| P/N | DESCRIPTION | EACH |
|---------|---------------------------------------|------|
| SL72001 | Key-Mate Flashlight | |
| SL72030 | Key-Mate Replacement Batteries, Pkg/4 | |



73001SL

Truly tiny, a "small wonder", **Streamlight's NANO LIGHT®** is an extremely small and super-bright light. Less than two inches tall and made from aircraft aluminum, **Nano** provides up to eight hours of run time with a 100,000-hour white LED. Flashlight uses four coin cells (included) and comes with a clip to attach it to a key chain, a tool belt, and more. Measures 1¹/₂". Black.

| P/N | DESCRIPTION | EACH |
|---------|-----------------------|------|
| 73001SL | Nano Light Flashlight | |



For hands-free lighting, both indoors and out, the weatherproof and sturdy **360° LED CAP LIGHT**, from **Energizer®**, provides superior illumination for any task. Its clip attaches securely to both caps and helmets, and the unique swivel base allows 360° rotation. Provides three light modes—high and low white for general lighting or red for preserving night vision. Yellow/Black.

| P/N | DESCRIPTION | EACH |
|-----------|---|--------------|
| INCAP11EH | Outdoor Headlight w/ Clip, Yellow/Black | |
| ALK91 | Replacement AA Battery | SEE PAGE 142 |



INCAP11EH

Litebox® and **Vulcan® LANTERNS**, from **Streamlight®**, feature sealed-beam systems with halogen bulbs. They're constructed of ABS thermoplastic with rubberized impact bumpers, lens rings, and cushioned grip handles for extra toughness. Lanterns come with 8W spots and 80,000 candlepower.

| P/N | DESCRIPTION | EACH |
|---------|---|--------------|
| SL45116 | Litebox Standard System Flashlight, 11 1/2"L x 7"H x 5 1/8"W, Orange/Black <i>Includes: 120VAC, 12V Chargers, Shoulder Strap & Mounting Rack</i> | |
| SL44000 | Vulcan Standard System Flashlight, 7 1/2"L x 6 1/2"H x 5"W, Yellow/Black (FM) <i>Includes: 120VAC, 12V Chargers, Shoulder Strap & Charging Rack</i> | |
| SL44001 | Vulcan Vehicle Mount System Flashlight, 7 1/2"L x 6 1/2"H x 5"W, Yellow/Black (FM) <i>Includes: Truck-Mountable 12V Direct Wire Charging Rack & Shoulder Strap</i> | |
| PRB612 | 6V, 12A Battery for SL45116 | SEE PAGE 143 |
| S45901 | 8W Bi-Pin Bulb (100 hr) | |
| 45911 | 8W Spot Lamp Assembly for Litebox | |



SL45116



SL44001

E-Spot® Firebox® LANTERNS, from **Streamlight®**, feature three shockproof **C4®** LEDs with a 50,000 hour lifetime and up to 615 lumens. Also their jumper selectable high and low settings allow selection of more light output or more runtime. Other features include an ABS thermoplastic housing, rubberized impact bumper, lens ring, and cushion-grip handle. A toggle switch makes use with gloves a snap too.

| P/N | DESCRIPTION | EACH |
|-----------|--|------|
| → SL45861 | E-Spot Firebox Standard System Flashlight, 11 1/2"L x 7"H x 5 1/8"W, Orange/Black <i>Includes: 120VAC, 12V Chargers, Shoulder Strap & Mounting Rack</i> | |
| → SL45877 | E-Spot Firebox Standard System Flashlight, 11 1/2"L x 7"H x 5 1/8"W, Yellow/Black <i>Includes: 120VAC, 12V Chargers, Shoulder Strap & Mounting Rack</i> | |



SL45861



SL45877

The bright, right-angled **Survivor® LED FLASHLIGHT** from **Streamlight®**, is a lightweight hand-held flashlight, designed for use in hazardous situations. It uses **C4 LED™** technology for exceptional power. The **Survivor® LED** is also water resistant and has microprocessor-controlled high and low lighting modes, including a Moonlight mode and Emergency Flash mode.

| P/N | DESCRIPTION | EACH |
|-----------|---|------|
| → SL90513 | Survivor LED Flashlight, 120VAC/DC, Yellow <i>Includes: Steady Charger</i> | |
| → SL90503 | Survivor LED Flashlight, 120VAC/DC, Orange <i>Includes: Steady Charger</i> | |
| → SL90500 | Survivor LED Flashlight (only), DC, Orange | |
| → SL90541 | Survivor LED Flashlight (only), Alkaline, Yellow | |
| → SL90540 | Survivor LED Flashlight (only), Alkaline, Orange | |



SL90503





SL68202

Streamlight's 4AA Propolymer FLASHLIGHTS are waterproof, tough, and dependable, and they won't cost you an arm and a leg. These non-conductive flashlights feature super-bright LEDs (67 lumens) as well as non-slip grips and tough polymer cases. They also incorporate helmet clamps (sold separately) for hands-free operation and use four AA-cell alkaline batteries (included). Measures 6 $\frac{1}{2}$ ".

| P/N | DESCRIPTION | EACH |
|---------|----------------------------------|--------------|
| SL68202 | 4AA LED Flashlight, Yellow/Black | |
| ALK91 | Replacement AA Battery | SEE PAGE 142 |



SL65018

Besides conveniently clipping to things like your shirt pocket, **Streamlight® Stylus® PEN LIGHTS** produce 11 lumens of powerful white light when needed. Each pen light features a 100,000-hour LED that you can switch from constant-on to momentary blink with the click of a button. And with a knurled anodized aluminum body and pocket clip, they're easy to hang on to. They're also water-resistant and use three AAAA-cell batteries (included). Both lights are CE approved. Black.

| P/N | DESCRIPTION | EACH |
|---------|--|------|
| SL65018 | Pen Light, 6 $\frac{1}{4}$ " Long | |
| SL65618 | Reach Pen Light, 14" (Extended), 6 $\frac{3}{4}$ " (Retracted) | |
| SL65030 | Replacement AAAA Batteries, Pkg/6 | |



SL65618

The lightweight, versatile, and comfortable **3 LED HEADLIGHT**, from **Energizer®**, is perfect for work that requires free hands. With its swivel and tilt adjustment, it puts light where you need it. Choose white flood or red night-vision for the best illumination without changing lights. Mounts securely and can be comfortably worn around the head for long periods of time. Three AAA-cell **Max®** batteries included.

| P/N | DESCRIPTION | EACH |
|--------|----------------------------------|--------------|
| HD33A1 | 3 LED Headlight, Black/Gray/Blue | |
| ALK92 | AAA Alkaline Battery | SEE PAGE 142 |



HD33A1

For the ultimate in convenience, safety, and dependability, choose **Streamlight's** hands-free **Trident®** or **Enduro™** **HEADLAMPS**. The **Trident** combines a **C4® LED** (11 lumens) with three standard LEDs (35 lumens), providing three-way lighting for short, medium, and long distances. It also offers spot-to-flood focus. The **Enduro** is not to be outdone with its super-bright .5W LED (14.5 lumens) and high/low beam modes. All headlamps are water-resistant with scratch-resistant polycarbonate bodies and lenses. Plus each features an adjustable elastic head strap for maximum comfort. **Trident** headlamp is UL listed.

| P/N | DESCRIPTION | EACH |
|---------|---|--------------|
| SL61050 | Trident Headlamp, Red/Black/Yellow Includes: (3) AAA-Cell Alkaline Batteries | |
| SL61400 | Enduro Headlamp, Black Includes: (2) AAA-Cell Alkaline Batteries | |
| ALK92 | Replacement AAA Battery | SEE PAGE 142 |



SL61050



SL61400

For Replacement Batteries, See Section 10.



Energizer® HIGH INTENSITY LED FLASHLIGHTS are extremely dependable in extreme circumstances. Weatherproof and made of machined aluminum, these flashlights pack a lot of punch into a small package. Features include a pushbutton tail switch and a single high-intensity LED that delivers 150 lumens. They also include a slip-resistant knurled grip and a nylon lanyard for additional safety. Gunmetal Gray.

| P/N | DESCRIPTION | EACH |
|----------|--|------|
| ELMCL21L | High Intensity LED 2AA Aluminum Flashlight | |
| L91BP4 | Ultimate Lithium AA Batteries, Pkg/4 | |



In a class by itself, the **Stinger® FLASHLIGHT**, from **Streamlight®**, sets the standard by which all other flashlights are judged. To start with, it is virtually indestructible, making it ideal for routine use in any environment. It also possesses potent power, thanks to its 3.6V, 1.8AH battery (rechargeable up to 1,000 times) and its xenon bi-pin bulb (providing 11,000 candlepower). Other features include an anodized aluminum housing, polycarbonate lens, and a spare xenon bulb in the tail cap. Each flashlight weighs 10 ounces, measures 7⁷/₁₆" in length, and provides one hour of continuous use between charges. Black.

| P/N | DESCRIPTION | EACH |
|---------|-------------------------------------|------|
| SL75014 | Stinger Flashlight w/ AC/DC Charger | |
| SL75175 | Replacement Battery for SL75014 | |



WARNING TAPES

Our quality selection of **BARRICADE TAPE** is made of 2.5 mil polyethylene and comes in 3" x 1,000' rolls for easy handling and storage. It can be tied, stapled, or nailed in place to secure sensitive areas and warn of physical hazards or dangerous situations. Yellow.

| P/N | DESCRIPTION | EACH |
|---------|----------------------------|------|
| SLYFL | "Fire Line Do Not Cross" | |
| SLYPL | "Police Line Do Not Cross" | |
| TH1000 | Tape Holder | |
| TH42003 | Barricade Tape Dispenser | |



For Additional Warning Tapes, See Section 5.

MUNICIPAL FIRE HOSE AND FITTINGS

Get the ultimate in high-performance with municipal-grade fire hose from **Brooks**. These durable **DOUBLE JACKET** and **YELLOW COATED FIRE HOSES** are constructed of 100% high-tensile-strength polyester yarns—both warp and filler—and lined with a high-tech E.P.D.M. tube, so they weigh less but last longer. NST aluminum coupled.

| P/N | DESCRIPTION | BOWL SIZE | WEIGHT COUPLED | EACH |
|--------------|--|-----------------------------------|----------------|------|
| DJ50ANST | Double Jacket, 50' x 1 ¹ / ₂ " | 1 ¹³ / ₁₆ " | 18 lbs | |
| DJ2550ANST | Double Jacket, 50' x 2 ¹ / ₂ " | 3" | 34 lbs | |
| DJ50YHANST | Yellow Coated, 50' x 1 ¹ / ₂ " | 1 ¹³ / ₁₆ " | 21 lbs | |
| DJ2550YHANST | Yellow Coated, 50' x 2 ¹ / ₂ " | 3" | 39 lbs | |



4 EMERGENCY RESPONSE PRODUCTS

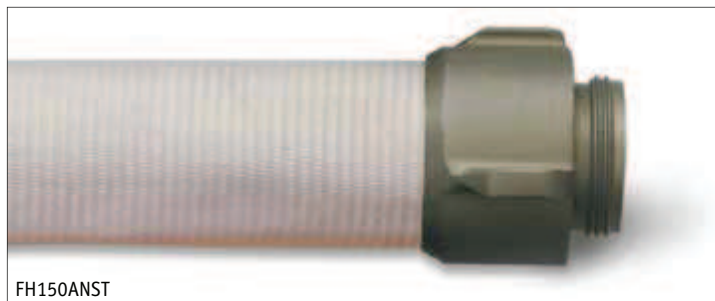

FH150ANST

For all of your **FORESTRY HOSE** needs, look to **Brooks**. Our selection of lightweight hose meets USDA-US Forest Service Specifications and features a burst pressure of 750 psi, an acceptance test pressure of 500 psi, and a service test pressure of 250 psi. NST aluminum coupled.

| P/N | DESCRIPTION | BOWL SIZE | WEIGHT COUPLED | EACH |
|------------|------------------------|---------------------------------|----------------|------|
| FH150ANST | 50' x 1" Alum | 1 ¹ / ₄ " | 7 lbs | |
| FH1100ANST | 100' x 1" Alum | 1 ¹ / ₄ " | 11 lbs | |
| HS01 | Hose Tote Strap System | | | |

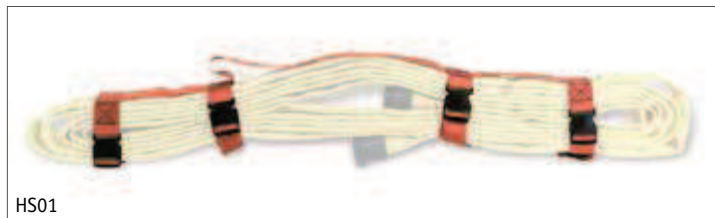

HS01

Designed for structural, vehicle, grass, and forestry firefighting, our line of **BOOSTER HOSE** can't be beat for quality and performance. Its outer jacket is constructed of a specially compounded red neoprene that resists abrasion, ultraviolet light, ozone, and most petrochemicals. It also has two braids of high-tensile rayon yarn for extra strength and a smooth Black SBR rubber tube for seamless flows. Each length has a burst pressure of 3,200 psi, an acceptance test pressure of 800 psi, and a service test pressure of 400 psi. NST aluminum coupled. Meets NFPA.



BH150ANST

| P/N | DESCRIPTION | BOWL SIZE | WEIGHT COUPLED | EACH |
|------------|-------------|----------------------------------|----------------|------|
| BH150ANST | 50' x 1" | 1 ⁹ / ₁₆ " | 31 lbs | |
| BH1100ANST | 100' x 1" | 1 ⁹ / ₁₆ " | 60 lbs | |



CG25



HH26

For Additional Hose Options, See Section 3.

Our selection of **HYDRAULIC TEST EQUIPMENT** features a variety of highly engineered products and instruments to handle your calculation needs. The **Inline** and **Cap Gauges** are easy to attach to hydrants, valves, etc. and provide a quick check of water pressure. The handheld **Pitot Gauge** and **Hydrant Test Kit** offer convenient methods of checking straight tip nozzle and hydrant pressures quickly and accurately.



HK25

| P/N | DESCRIPTION | EACH |
|------|---|------|
| CG25 | Cap Gauge (0–300 psi), 2 ¹ / ₂ " NST | |
| LG25 | Inline Gauge (0–300 psi), 2 ¹ / ₂ " NST | |
| HH26 | Pitot Gauge (0–160 psi) | |
| HK25 | Hydrant Test Kit (0–160 psi), 2 ¹ / ₂ " NST | |



HH1



HH1 In Use

MUNICIPAL HAND TOOLS

Very handy to have around, our **HOSE HOOK** is a multi-purpose tool that carries hose rolls and fits up to 5" hose. It doubles as a wrench for rocker and pin lug fittings (up to 2¹/₂") as well as 4" and 5" storz fittings. It also opens foam bucket lids, drains hose, and holds doors open. Comes with a bracket for apparatus mounting too.

| P/N | DESCRIPTION | EACH |
|-----|-------------|------|
| HH1 | Hose Hook | |



Designed for today's fire department connections, these popular **WRENCHES** cover a variety of sizes in both storz and threaded adapters (pin or rocker lugs).

| P/N | DESCRIPTION | EACH |
|------|---|------|
| STW | Storz x Universal Spanner (Alum) Fits 4"-6" Storz & 1½"-3" Rocker Lugs | |
| STH | Storz Spanner Wrench Holder | |
| W570 | Universal Spanner Wrench (Alum) Fits 1½"-3" Pin/Rocker Lugs | |
| W580 | Standard Hydrant/Spanner Wrench (Steel/Ductile Iron) Fits 1½"-6" Pin/Rocker Lugs | |
| W575 | Heavy-Duty Hydrant/Spanner Wrench (Steel/Ductile Iron) Fits 1½"-6" Pin/Rocker Lugs | |
| K48 | Hydrant/Spanner Wrench Holder (No Tools) | |
| AFS | Folding Pocket Spanner Wrench (Plastic) Fits Pin/Rocker Lugs Thru 4" | |

RESCUE TOOLS include the **Res-Q-Rench**, which is five tools in one: universal spanner, pry tool, window punch, seat belt cutter, and gas shut-off. There's also the **Res-Q-Me** that shatters tempered glass and cuts through safety belts in seconds.

| P/N | DESCRIPTION | EACH |
|------|---|------|
| RQR | Res-Q-Rench (Plastic) Fits 4", 5" Storz & 1½", 2½" Rocker Lugs | |
| RST1 | Res-Q-Me Tool | |

The **89 RESCUE TOOL**, from **Channellock®**, has a spanner wrench that works on storz and rocker lug couplings (up to 6"). There's also a tool steel punch to shatter safety glass, a pry bar for doors and windows, a gas shutoff, and hardened steel edges that easily shear through soft metal. And its narrow profile helps it work wonders in tight places.

| P/N | DESCRIPTION | EACH |
|------|----------------|------|
| TL89 | 89 Rescue Tool | |

Our collection of municipal-grade **FIRE AXES** includes four different styles with or without pick heads and solid hickory or yellow fiberglass handles—all with 6 lb heads. Optional mounting bracket and hooks available separately.

| P/N | DESCRIPTION | EACH |
|-------|---|------|
| 406M* | Pick Head Fire Axe w/ 36" Hickory Handle | |
| 406Y* | Pick Head Fire Axe w/ 36" Fiberglass Handle | |
| 407Y* | Flat Head Fire Axe w/ 34" Fiberglass Handle | |
| D406M | Pick Head Fire Axe w/ 36" Hickory Handle (Domestic) | |
| D406Y | Pick Head Fire Axe w/ 36½" Fiberglass Handle (Domestic) | |
| D407Y | Flat Head Fire Axe w/ 36½" Fiberglass Handle (Domestic) | |
| D407M | Flat Head Fire Axe w/ 36" Hickory Handle (Domestic) | |
| AB408 | Axe Bracket & Hook | |

*WHILE QUANTITIES LAST

MUNICIPAL VALVES

Both the **Gated Wye** and **Swivel Gate MUNICIPAL VALVES** are engineered from lightweight cast aluminum with powder coated bodies and hard anodized extruded aluminum inlets/outlets for maximum performance and corrosion resistance. The **Gated Wye** also has powder coated handles with an orange peel finish for easy gripping, while the **Swivel Gate Valve** features a non-rising brass stem with aluminum hand crank for fast, trouble-free operation.

| P/N | DESCRIPTION | EACH |
|------|---|------|
| 9443 | Swivel Gate Valve, 2½" NST(F) x 2½" NST(M) | |
| 9611 | Gated Wye, 2½" NST(F) x 1½" NST(M) x 1½" NST(M) | |



Available In Select Or Constant Gallonage



Brooks' collection of Viper FIREFIGHTING NOZZLES includes the very best municipal nozzles available. Offered in a variety of styles, sizes, and construction, these nozzles are the professional's choice for municipal and industrial applications.

Standard Features

- E-Lite aluminum construction with brass internal parts
- Fog-to-straight stream with a twist of the bumper
- Flushable without shutting down
- Full-time swivels and removable pistol grips
- Constant flow through fog and straight stream

| P/N | DESCRIPTION | EACH |
|--------|--|------|
| SG3012 | 1 1/2" Viper Select Gallonage, NST (30, 60, 95, 125 gpm) | |
| P45SV | 1 1/2" Viper, Constant Gallonage, NST (95 gpm) | |



POK1448

FOAM EDUCTORS

POK's IN-LINE EDUCTORS are easy to install and feature a metering knob for easy, economical dispersal of 0%–6% foam solutions. They're easy to maintain with a low-pressure drop too. Eductors also come complete with 10' pick-up tube and an NST inlet.

| P/N | DESCRIPTION | EACH |
|---------|------------------------------|------|
| POK1448 | 1 1/2" Foam Eductor, 95 gpm | |
| POK1444 | 1 1/2" Foam Eductor, 125 gpm | |



DDPPOK9957

The **POK LOW EXPANSION FOAM NOZZLE** is made from aluminum with a red **NITUFF™** finish. This 8" nozzle provides excellent reach and penetration with an expansion ratio of 10.

| P/N | DESCRIPTION | EACH |
|------------|---|------|
| DDPPOK9957 | 1 1/2" Air ASP Foam Nozzle, NST, 95 gpm | |



WBES45

BACKPACK EXTINGUISHING SYSTEM

The **Genfo-45 WILDLAND BACKPACK EXTINGUISHING SYSTEM** features a large 4 1/2 gal reservoir and internal baffle for a substantial yet stable transportable water supply. It also includes a double-action hand pump and a 40" x 1/4" hose with a fully adjustable nozzle, a carry handle, and shoulder straps for easy transportation. Weighs 4 lbs empty and measures 25 1/2"H x 19 5/16"W x 1"D.

| P/N | DESCRIPTION | EACH |
|-----------|------------------------------------|------|
| WBES45 | Genfo-45 Water Backpack | |
| WBES45FT* | Foam Application Tube for Genfo-45 | |
| | *SPECIAL ORDER | |

CHEMICAL

Brooks carries a wide selection of **FOAM** products to meet your specific needs. The **36AFFF** is all-synthetic film-forming foam, designed for use on water-soluble polar solvents and water-insoluble hydrocarbon flammable liquids. The **3AFFF** and **6AFFF** are synthetic aqueous film-forming foam concentrates, designed for use on non-polar hydrocarbon hazards.

NOTE: TFOAM is for live fire-training sessions only.

| P/N | DESCRIPTION | SIZE | EACH |
|--------|-------------------------------------|------------|------|
| 36AFFF | 3% or 6% AR-AFFF Foam | 5 gal Pail | |
| 3AFFF | 3% AFFF Foam | 5 gal Pail | |
| 6AFFF | 6% AFFF Foam | 5 gal Pail | |
| TFOAM | 3% or 6% AFFF Virtual Training Foam | 5 gal Pail | |
| AFOAM | Class A Foam | 5 gal Pail | |



36AFFF



3AFFF



6AFFF



AFOAM



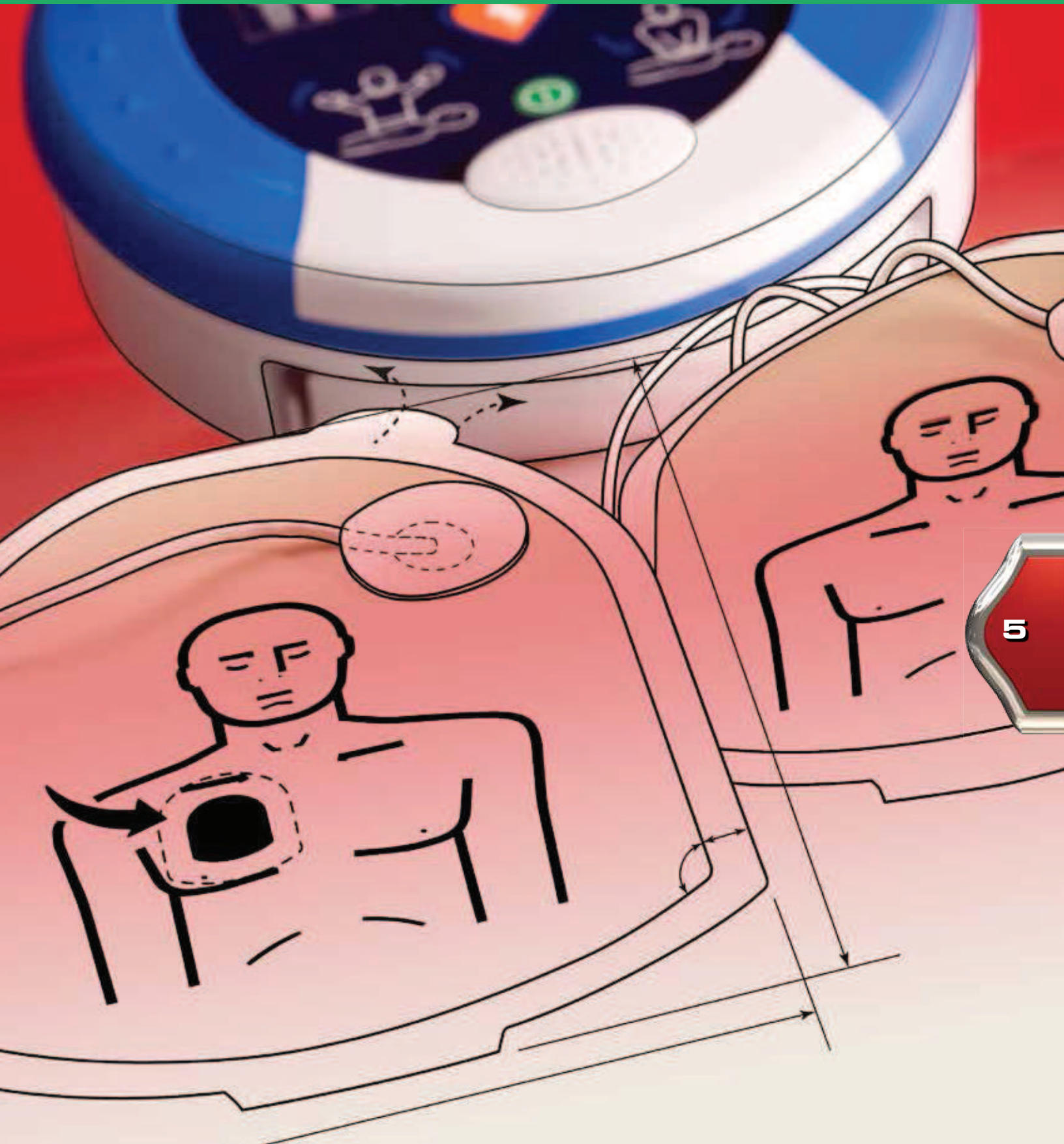

*Life Safety Products: Everything you need
to save more than money.*



NFPA1013, NFPA1713

CODES AND REGULATIONS

For nearly a century, people have relied on **NFPA® PUBLICATIONS**—your blueprints to safety.

| P/N | DESCRIPTION | EACH |
|------------|--|------|
| NFPA1013 | NFPA 10: Standard for Portable Fire Extinguishers, 2013 ed | |
| NFPA1713 | NFPA 17: Standard for Dry Chemical Extinguisher Systems, 2013 ed | |
| NFPA17A13 | NFPA 17A: Standard for Wet Chemical Extinguisher Systems, 2013 ed | |
| → NFPA9614 | NFPA 96: Standard for Ventilation Control & Fire Protection of Commercial Cooking Operations, 2014 ed | |
| NFPA10112 | NFPA 101: Life Safety Code, 2012 ed | |
| NFPA7213 | NFPA 72: National Fire Alarm and Signaling Code, 2013 ed | |
| NFPA196309 | NFPA 1963: Standard for Fire Hose Connections, 2013 ed | |
| NFPA196213 | NFPA 1962: Standard for the Inspection, Care & Use of Fire Hose, Couplings & Nozzles & the Service Testing of Fire Hose, 2013 ed | |
| NFPA1313 | NFPA 13: Standard for the Installation of Sprinkler Systems, 2013 ed | |

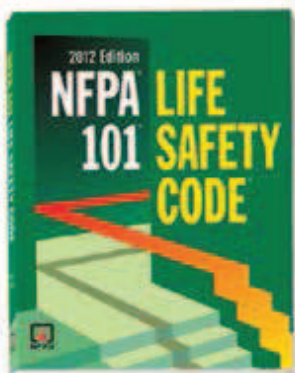

NFPA10112

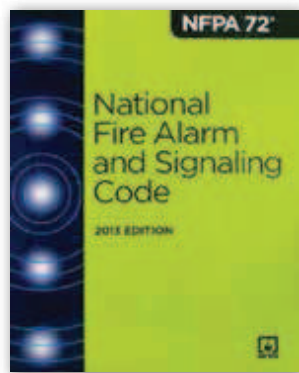

NFPA7213

CODE OF FEDERAL REGULATIONS TITLE 49,

Parts 100–185, as required for all DOT testing shops and persons transporting hazardous materials (including fire extinguishers). This manual is printed every spring and includes all changes through October 1st of the previous year.

| P/N | DESCRIPTION | EACH |
|-------|--|------|
| DOT13 | DOT Code of Regulations, Parts 100–185 | |

CODE OF FEDERAL REGULATIONS TITLE 29,

OSHA, Parts 1901.1–1910.999 and 1910.1000–End. Revised July 1, 2013, and covers OSHA's general industry safety and health standards for the workplace, including lockout/tagout, confined space entry procedures, personal protective equipment, fire extinguishers, permissible exposure limits, first aid, illnesses, and procedures for recording and reporting.

| P/N | DESCRIPTION | EACH |
|---------|---|------|
| CFR2913 | 2013 Code of Federal Regulations Title 29, 2-Volume Set | |

EMERGENCY RESPONSE GUIDEBOOK meets DOT 49CFR, section 172.602 requirement. Any person transporting hazardous materials must carry one of these (or all material safety data sheets pertaining to materials being transported in the vehicle).

| P/N | DESCRIPTION | EACH |
|------|------------------------------|------|
| ERGB | Emergency Guidebook, 2012 ed | |

FEDERAL MOTOR CARRIER SAFETY REGULATIONS,

Parts 40, 380, 382, 383, 387, 390–397, and 399. This book applies to any vehicle required to placard or any vehicle with a gross weight rating of 26,000 lbs or higher. Also necessary to meet driver training requirement in DOT 49CFR, section 177.816.

| P/N | DESCRIPTION | EACH |
|-------|--|------|
| FMCSR | Federal Motor Carrier Safety Regulations | |

Pocket-sized **BROOKS COMPLIANCE GUIDE** summarizes the most common NFPA Standards and OSHA Regulations found in our industry. Complete with product recommendations for specific standard, code, and regulation titles. Also available as an app. See page 1.

| P/N | DESCRIPTION | EACH |
|-----|-------------------------|------|
| BCG | Brooks Compliance Guide | |



DOT13

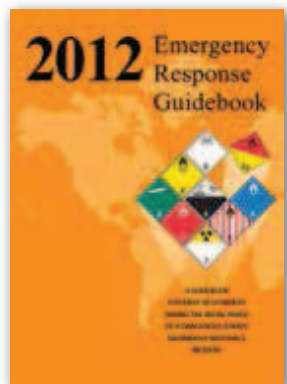

ERGB

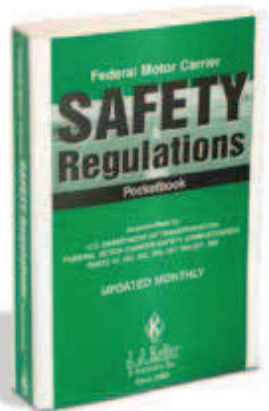

FMCSR



BCG



DOT SUPPLIES

VEHICLE INSPECTION REPORT, as required by 49CFR, sections 396.11 and 396.13. This is a three-part carbon form, consecutively numbered, measuring 9½" x 5¼".

| P/N | DESCRIPTION | EACH |
|--------|------------------------------------|------|
| VIR100 | Vehicle Inspection Report, Pkg/100 | |

Dry erase **SHIPPING DOCUMENT** is preprinted with the most common materials to meet 49CFR requirements, section 177.817. Updated to match most recent DOT changes.

| P/N | DESCRIPTION | EACH |
|--------|--|------|
| HMSPDE | Dry Erase Hazardous Materials Shipping Paper | |
| RDEP | Red Dry Erase Pen | |

Vinyl **SHIPPING PAPER DOOR POUCH** meets shipping paper accessibility requirement (49CFR, section 177.817). Includes snaps for door attachment and measures 15" x 10½". Department of Transportation requires that, "When the driver is not at the vehicle controls, the shipping paper shall be: (A) In a holder, which is mounted to the inside of the door on the driver's side of the vehicle; or (B) on the driver's seat in the vehicle."

| P/N | DESCRIPTION | EACH |
|-----|-----------------------------------|------|
| VDP | Vehicle Door Pouch for DOT Papers | |

CYLINDER VALVE GUARD and **CAP** meet DOT, OSHA, and MSHA requirements. **GT11** can be fitted and padlocked over cylinder valve with regulator attached. The **CCAP** can be fitted over cylinder valves only. Measures 3¼" x 11 threads per inch.

| P/N | DESCRIPTION | EACH |
|------|----------------------|------|
| GT11 | Cylinder Valve Guard | |
| CCAP | Cylinder Cap | |

CYLINDER RACK SYSTEM can be used to meet DOT 49CFR, section 177.840 requirement for transporting compressed gas cylinders. Series E horizontal track is finished with a gray primer, ready to install. The 2" cylinder belt straps come with ratchet buckle and spring-loaded fittings.

| P/N | DESCRIPTION | EACH |
|-----|--------------------------------------|------|
| ETK | 5' Section E-Track | |
| CB2 | Cylinder Belt 6" Fixed x 3' Adj. | |
| CB1 | Cylinder Belt 23" Fixed x 6' Adj. | |

Save-A-Load® CARGO BAR keeps your cargo in place. Features a maintenance-free pump with pushbutton instant release and a pressure-limiting valve that protects the walls of the vehicle. The pivoting feet and non-slip rubber pads enable the bar to grip any surface, even bedliners. Adjusts from 47"-75" in length.

| P/N | DESCRIPTION | EACH |
|------|-----------------------|------|
| PUCB | Save-A-Load Cargo Bar | |

PLACARD for meeting DOT 49CFR, section 172.519 requirement of placarding when carrying more than 1,000 lbs aggregate gross weight of hazardous materials. Placard can display the following: Oxygen, Flammable Gas, Non-Flammable Gas, Inhalation Hazard, and one blank.

| P/N | DESCRIPTION | EACH |
|------|-----------------------------|------|
| VHP1 | "Non-Flammable Gas" Placard | |

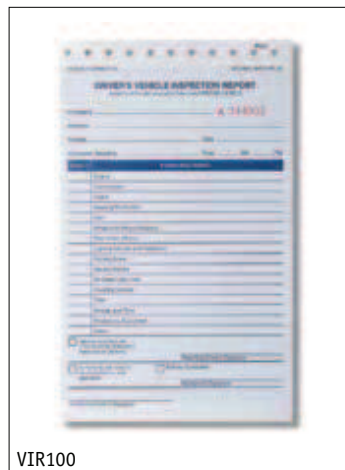

VIR100



HMSPDE, VDP



RDEP



GT11



CCAP

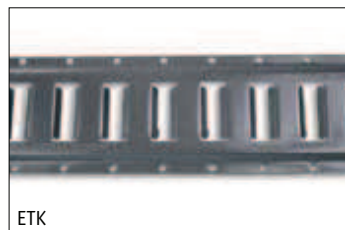

ETK



CB1



ETK, CB1 IN USE



PUCB



VHP1



Works on Ice and Snow



HDWC

Keep your service truck or van in place with this heavy-duty rubber **WHEEL CHOCK**. This gripping chock features a fluted design for increased downward pressure, assuring your tire stays locked in place, even on ice and snow.

| P/N | DESCRIPTION | EACH |
|------|-------------|------|
| HDWC | Wheel Chock | |



TC18R, TC18



TCH In Use



TD42

TRAFFIC SAFETY

Our **TRAFFIC CONES** are molded of polyvinyl chloride with the cone and base being one continuous layer to prevent separation. Cones are designed for easy stacking (without sticking) and return to shape when crushed. High-Vis Red/Orange.

| P/N | DESCRIPTION | EACH |
|--------|--|------|
| TC12 | 12" Cone | |
| TC18R | 18" Cone w/ 6" Reflective Stripe | |
| TC18 | 18" Cone | |
| TC28 | 28" Cone | |
| TC2864 | 28" Cone w/ 4" & 6" Reflective Stripes | |
| TC36 | 36" Cone | |
| TCH | Traffic Cone Holder | |
| TD42 | 45" Traffic Delineator Post & Base | |

COLLAPSIBLE CONES are extraordinarily bright and easy to see, thanks to their hi-vis orange material, reflective bands, and battery-powered LED light inside the cone. The light also features three modes—flashing, on, and off. Cones collapse flat for easy storage and include two AAA batteries for LED light. **CTC528TS** meets NFPA 1901 requirements.

| P/N | DESCRIPTION | EACH |
|----------|-----------------------------|------|
| CTC418TS | 18" Collapsible Cone, Pkg/4 | |
| CTC428TS | 28" Collapsible Cone, Pkg/4 | |
| CTC528TS | 28" Collapsible Cone, Pkg/5 | |

REFLECTOR TRIANGLE KIT, as required by FMCSR, section 393.95, consists of three triangles in a plastic storage box. Box weighs 15 lbs.

| P/N | DESCRIPTION | EACH |
|------|---------------------------------|------|
| 3TKD | 3-Piece Reflective Triangle Kit | |

These handy **MEASURING WHEELS** accurately track inches and feet and are fully automatic. Each wheel comes with a mechanical counter, push-button zero reset, impact-resistant wheels, and a telescoping aluminum handle. The **Single Wheel** model reads up to 10,000' and measures 16³/₄" (collapsed) and 38¹/₄" (extended). The **Double Wheel** model reads up to 10,000' and measures 21³/₄" (collapsed) and 38" (extended), and its pistol grip design reduces wrist fatigue.

| P/N | DESCRIPTION | EACH |
|------|------------------------|------|
| DMWC | Single Measuring Wheel | |
| DMWM | Double Measuring Wheel | |



CTC428TS



3TKD



DMWC



DMWM



These **STANDARD SAFETY FLARES** can be used day or night in thick fog, snow, or rain. Flares burn bright red. Sold in package quantities only.

NOTE: Additional hazardous material shipping charges apply to these products.

| P/N | DESCRIPTION | PKG QTY | EACH |
|----------|-------------------------------|---------|------|
| SF2072 | 20-Minute Flare, Non-Spiked | 72 | |
| SF3036 | 30-Minute Flare, Non-Spiked | 36 | |
| SF2072S | 20-Minute Flare, Spiked | 72 | |
| SF3036S | 30-Minute Flare, Spiked | 36 | |
| SF3036WS | 30-Minute Flare w/ Wire Stand | 36 | |



Keep flares handy in case of emergency with a **SAFETY FLARE CONTAINER**. The red plastic container is water-resistant and virtually indestructible. Holds up to a dozen 30-minute flares. A must for fire trucks, rescue, and police. Excellent for personal use as well. Flares not included.

| P/N | DESCRIPTION | EACH |
|------|------------------------|------|
| FC30 | Safety Flare Container | |



Snaplight® LIGHTSTICKS don't produce heat or sparks, only bright, hazard-free light with a single snap. Illumination is created through a non-toxic, non-flammable chemical reaction. They are weatherproof and maintenance free with 360° of illumination a mile away. Magnetic holder (sold separately) holds both 6" and 10" lightsticks.

| P/N | DESCRIPTION | EACH |
|--------|-------------------------------|------|
| LSBL8 | 6" Blue Lightstick, 8-Hour | |
| LSWH8 | 6" White Lightstick, 8-Hour | |
| LSY12 | 6" Yellow Lightstick, 12-Hour | |
| LSG12 | 6" Green Lightstick, 12-Hour | |
| LSR12 | 6" Red Lightstick, 12-Hour | |
| LSOR12 | 6" Orange Lightstick, 12-Hour | |
| MLSH | Magnetic Lightstick Holder | |



FORM HOLDER holds and organizes loose forms, invoices, work orders, etc. Swivel bar clip with a writing plate makes it easy to fill out invoices and other forms.

| P/N | DESCRIPTION | EACH |
|--------|-------------|------|
| FH8512 | Form Holder | |

The **NOTEBOOK MOBILE DESK** is ideal for anyone who uses their vehicle as an office and needs a comfortable writing surface. It installs over any 16" steering wheel in seconds. Perfect for laptops and tablets. Measures 15 1/4" x 13 1/4" .

| P/N | DESCRIPTION | EACH |
|------|-------------|------|
| MDWG | Mobile Desk | |





I222U

PERSONAL SAFETY

The **Work Master™ LIFE VEST**, from **Stearns®**, is a must for the many marine-type jobs encountered in the fire safety industry. Constructed from closed-cell foam with encircling body belt, these work vests feature a snag-resistant buckle for quick adjustment and marine mesh lining for breathability. A flotation collar and **SOLAS**-grade reflective tape are added for additional protection. USCG approved, Type III/V work vest.

| P/N | DESCRIPTION | EACH |
|--------|--|------|
| I222U | Work Master Life Vest, Adult Universal | |
| I222OS | Work Master Life Vest, Adult Oversize | |



MPHONES

These **MEGAPHONES** have a superior audio system with an acoustic range of up to one mile for loud and clear messaging. They also feature a comfortable pistol-grip with trigger switch for one-handed operation. Each comes standard with an adjustable volume control, microphone, and alarm siren. Units are powered by eight C-cell alkaline batteries (not included) and measure 14½"L x 9"Dia.

| P/N | DESCRIPTION | EACH |
|---------|--------------------|------|
| MPHONES | Megaphone w/ Siren | |
| ALK93 | C Alkaline Battery | |

SEE PAGE 142



SDS

Convenient **SELF-DEFENSE SPRAY** goes with you anywhere—in your pocket or on your key ring. When needed, it fires a powerful cone-shaped stream of **3-in-1® Formula** with highly effective results. Every ½ oz self-defense spray includes a snap-close holster and key ring for easy concealment/attachment.

NOTE: See product listing on brooksequipment.com for shipping prohibitions.

| P/N | DESCRIPTION | EACH |
|-----|--------------------|------|
| SDS | Self-Defense Spray | |



KRSW1

PLASTIC SAFETY WHISTLE with attached lanyard.

| P/N | DESCRIPTION | EACH |
|-------|----------------|------|
| KRSW1 | Safety Whistle | |

The **ProFlex® 400 UNIVERSAL WRIST WRAP** supports your wrists and prevents strains and pains with its durable woven elastic construction. Adjust hook-and-loop closure to exact tension and fit. Works for both left and right wrists. One size.

| P/N | DESCRIPTION | EACH |
|------|-----------------------------|------|
| WRST | Universal Wrist Wrap, Black | |

ProFlex® BACK SUPPORTS feature adjustable/detachable suspenders, non-conductive polypropylene stays, and 7½" elastic body. Their design also helps remind the wearer to lift properly. There's a single-layer 5", elastic cinch strap for positive tension as well. Black.

| P/N | DESCRIPTION | SIZE | EACH |
|-------|------------------------------|------|------|
| BSBS | Back Support Belt 25"-30" | S | |
| BSBM | Back Support Belt 30"-34" | M | |
| BSBL | Back Support Belt 34"-38" | L | |
| BSBXL | Back Support Belt 38"-42" | XL | |



WRST



BSBS



LADDERS, BLANKETS, AND RETARDANT

Portable emergency **ESCAPE LADDERS** store easily for quick access in an emergency. No assembly required—just hang the brackets over the window sill, toss out the ladder, and climb down. Features anti-slip rungs and five-year warranty. Tested to 1,000 lbs. **NOTE:** One time use only.

| P/N | DESCRIPTION |
|------|----------------------------------|
| KL2S | 13' Emergency Fire Escape Ladder |
| KL3S | 25' Emergency Fire Escape Ladder |



KL2S

Inspecta-Shield™ FIRE RETARDANT, by **N.Y. Fire Shield**, is a Class A fire retardant for fibers, lumber, and wood materials. Pre-mixed, easy to apply, non-toxic, non-allergenic, colorless, odorless (when dried), durable, and UV stable. UL classified and approved by the CA State Fire Marshal. Works by slowing horizontal and vertical flame spread. Does not prevent charring, but treated items will not support ignition. Directions are included. Not recommended for outdoor use.

NOTE: UL Letter of Certification can be granted up to two years after the date of manufacture.

| P/N | DESCRIPTION | EACH |
|------|----------------------------|-------|
| FRQS | Fire Retardant, 1 qt Spray | |
| FRG | Fire Retardant, 1 gal | |
| FRP5 | Fire Retardant, 5 gal | ----- |



FRQS



FRG

FIBERGLASS BLANKET comes in a low-profile plastic **CABINET**, complete with instruction labels and pull straps for quick withdrawal. Cabinet measures 14 1/4"H x 6 1/4"W x 1 1/2"D. Blanket measures 72" x 48". One-time use only.

| P/N | DESCRIPTION | EACH |
|------|------------------------|------|
| 64FB | Fire Blanket & Cabinet | |



64FB FRONT VIEW



64FB BACK VIEW

WOOL BLANKET measures 80" x 56" and is treated for fire retardancy. **VINYL BAG** measures 17"L x 12"W x 4"D. Features four mounting holes with brass grommets and hook-and-loop closure. Items sold separately.

| P/N | DESCRIPTION | EACH |
|------|-----------------------|------|
| FBB1 | Fire Blanket Bag Only | |
| FBR2 | Fire Blanket for FBB1 | |

Roller-mounted **WOOL BLANKET** with arm loop measures 80" x 56" and is treated for fire retardancy. **ALL-STEEL CABINET** with red-enamel finish measures 68"H x 6 1/2"W x 4 7/8"D. Items sold separately.

| P/N | DESCRIPTION | EACH |
|------|------------------------------------|------|
| 1FB | Fire Blanket Roll-Out Cabinet Only | |
| FBR1 | Fire Blanket for 1FB | |



FBB1, FBR2



1FB



Flame-Resistant Quality



M2FBC

ABS CABINET with **WOOL BLANKET** features a brass lock and screenprinted labeling. Cabinet is made of high-impact, flame-retardant ABS. Blankets are 80" x 56" and treated for fire retardancy. No dangerous glass to break, rustproof, and theft-resistant. Red tub with clear cover.

| P/N | DESCRIPTION | EACH |
|-------|---------------------------------|------|
| M2FBC | Fire Blanket Cabinet w/ Blanket | |
| M2RFC | Fire Blanket Tub Only | |
| FBR2 | Fire Blanket | |
| M2C | Clear Replacement Cover | |
| M12L | Brass Padlock, Keyed-Alike | |

SEE PAGE 33



2FB, FBR2

WOOL BLANKET is treated for fire retardancy and measures 80" x 56". **ALL-STEEL CABINET** features a tailgate-style door and red enamel finish. Cabinet measures 10"H x 16"W x 7³/₈"D. Items sold separately.

| P/N | DESCRIPTION | EACH |
|------|-------------------------------------|------|
| 2FB | Drop-Down Fire Blanket Cabinet Only | |
| FBR2 | Fire Blanket for 2FB | |

EMERGENCY PREPAREDNESS

Brooks' Ready Tube™ PERSONAL EVACUATION KIT provides water and protection from particulate contaminants in an economical, space-saving package, and it meets Department of Homeland Security recommendations for emergency preparedness. Plus it includes a family communications plan and extra room for personal items and medication.

READY TUBE CONTENTS

| | |
|--------------------------|-------------------------------|
| (1) N95 Mask | (1) Tissue Pack |
| (1) Flashlight | (1) Biohazard Bag |
| (1) First Aid Kit | (1) Family Communication Plan |
| (1) Pair Sanitary Gloves | (2) Drinking Water Pouch |
| (1) Thermal Blanket | (1) Snap Light |
| (1) Poncho | (2) Batteries AAA, Pkg/2 |
| (1) Whistle | (2) Batteries AA, Pkg/2 |

| P/N | DESCRIPTION | L X DIA | EACH |
|--------|------------------------------------|----------|------|
| READY1 | Ready Tube Personal Evacuation Kit | 10" x 5" | |

Brooks' Ready Kit™ 5-PERSON EMERGENCY PREPAREDNESS

provides food, water, and protection from particulate contaminants for five people, and it meets the Department of Homeland Security recommendations for particulate contaminants emergency preparedness. Housed in a hi-vis-orange backpack, the **Ready Kit** has a five-year shelf life and includes an emergency manual to keep you informed.

READY KIT CONTENTS

| | |
|----------------------------|--------------------------|
| (5) N95 Masks | (5) Thermal Blankets |
| (5) Food Bars | (5) Ponchos |
| (10) Water Pouches, 4.3 oz | (5) Whistles |
| (5) Lightsticks | (5) Tissue Packs, Pkg/10 |
| (1) Pair Safety Gloves | (2) Biohazard Bags |
| (2) Pairs Sanitary Gloves | (1) Emergency Manual |

| P/N | DESCRIPTION | L X H X D | EACH |
|--------|---|----------------|------|
| READY5 | Ready Kit, 5-Person Emergency Preparedness | 12" x 10" x 8" | |



READY1



READY5



HEAD PROTECTION

Football fans across the country can have on-the-job protection, while showing loyalty to their favorite team. Officially-licensed **NFL® LOGO V-GARD® HELMETS**, from **MSA**, are fun to wear, and each one meets or exceeds the requirements for Type 1 helmets, per ANSI Z89.1-2009 (Class E) and CSA Z94.1-2005 (Class E). Plus every cap features **1-Touch®** suspension, guaranteeing easy adjustment with superior comfort. Available in all 32 NFL teams.

| P/N | DESCRIPTION | EACH | P/N | DESCRIPTION | EACH |
|--------|----------------------|------|---------|----------------------|------|
| ARZHAT | Arizona Cardinals | | MIAHAT | Miami Dolphins | |
| ATLHAT | Atlanta Falcons | | MINHAT | Minnesota Vikings | |
| BALHAT | Baltimore Ravens | | NEPHAT | New England Patriots | |
| BUFHAT | Buffalo Bills | | NOSHAT | New Orleans Saints | |
| CARHAT | Carolina Panthers | | NYGHAT | New York Giants | |
| CHIHAT | Chicago Bears | | NYJHAT | New York Jets | |
| CINHAT | Cincinnati Bengals | | OAKHAT | Oakland Raiders | |
| CLVHAT | Cleveland Browns | | PHLHAT | Philadelphia Eagles | |
| DALHAT | Dallas Cowboys | | PITHAT | Pittsburgh Steelers | |
| DENHAT | Denver Broncos | | SDCHAT | San Diego Chargers | |
| DETHAT | Detroit Lions | | SF49HAT | San Francisco 49ers | |
| GBPHAT | Green Bay Packers | | SEAHAT | Seattle Seahawks | |
| HOUHAT | Houston Texans | | SLRHAT | St. Louis Rams | |
| INDHAT | Indianapolis Colts | | TBBHAT | Tampa Bay Buccaneers | |
| JACHAT | Jacksonville Jaguars | | TENHAT | Tennessee Titans | |
| KCCHAT | Kansas City Chiefs | | WSHHAT | Washington Redskins | |

MSA Freedom Series™ HELMET shows your patriotism and protects your head at the same time. **Fas-Trac®** suspension ensures your helmet is lightweight, durable, and comfortable. Accessory slots accept all **MSA V-Gard** accessories.

| P/N | DESCRIPTION | EACH |
|-------|--|------|
| USAHH | V-Gard Helmet w/ Fas-Trac, Stars & Stripes | |
| CAMOH | V-Gard Helmet w/ Fas-Trac, Camo | |

HARD HATS are made of high-density polyethylene. The ratchet suspension models won't fall off, even when working upside down. The **HH1**, **HH2**, and **HH4** models meet ANSI Z89.1-2009, Type I, Class E and CSA Z94.1-2005, while the **HH3** meets Type II, Class E requirements with an inner foam liner for off-center (front, back, and side) impact. Hard hats will accept most visors and hearing protection devices listed elsewhere (except **HH4**).

| P/N | DESCRIPTION | EACH |
|------|-------------------------------------|------|
| YHH1 | Yellow Hard Hat | |
| WHH1 | White Hard Hat | |
| YHH2 | Yellow Hard Hat w/ Ratchet | |
| WHH2 | White Hard Hat w/ Ratchet | |
| OHH2 | Orange Hard Hat w/ Ratchet | |
| WHH3 | White Hard Hat w/ Ratchet (Type II) | |
| WHH4 | White Full-Brim Hard Hat w/ Ratchet | |

HARD HAT ACCESSORIES include a visor adapter, made of tough aluminum, that fits all **Brooks'** hard hats (except **WHH3** and **WHH4**). The **A8150** face shield, made of clear 0.040"-thick PET-G and the **A8154** face shield, formed from clear 0.040"-thick polycarbonate, are recommended for general eye and face protection. Both measure 8" x 15½". They also work with hard-hat-mounted earmuffs.

| P/N | DESCRIPTION | EACH |
|--------|---------------------------------|------|
| HHA102 | Hard Hat Visor Adapter | |
| A8150 | Clear PETG Face Shield | |
| A8154 | Clear Polycarbonate Face Shield | |



DALHAT



GBPHAT



NOSHAT



PITHAT



USAHH



CAMOH



YHH1



WHH2



OHH2



WHH4



HHA102 W/ A8150





BK114C



BK118C



BKH10C



BKH25GC



EW108



EW102

EYE PROTECTION

Crews BearKat® SAFETY GLASSES get their tenacity from flexible temples and their hold from non-slip rubber head grips. Add to that, their unobstructed view (courtesy of wraparound lenses coated in scratch-resistant **Duramass®**), really cool colors, and very affordable prices. Meets ANSI Z87.1+ requirements. 99.9% UV protection.

| P/N | DESCRIPTION |
|----------|-----------------------------|
| BK110AFC | Clear, Anti-Fog |
| BK110C | Clear |
| BK112AFC | Gray, Anti-Fog |
| BK112C | Gray |
| BK113C | Light Blue |
| BK114C | Amber |
| BK117C | Silver Mirror |
| BK118C | Blue Mirror |
| BK119C | Indoor/Outdoor Clear Mirror |

BearKat® MAGNIFIER SAFETY GLASSES, from **Crews**, provide a lightweight fit that's comfortable and safe. The snug fit protects eyes, while wraparound lenses create a wide, unobstructed peripheral view. Flexible temples and non-slip rubber head grips keep things secure and comfortable, while a **Duramass®** scratch-resistant coating keeps lenses clearer longer. Meets ANSI Z87.1+ requirements. 99.9% UV protection.

| P/N | DESCRIPTION |
|---------|-------------------------------|
| BKH10C | Clear Magnifiers, 1.0 Diopter |
| BKH10GC | Gray Magnifiers, 1.0 Diopter |
| BKH15C | Clear Magnifiers, 1.5 Diopter |
| BKH15GC | Gray Magnifiers, 1.5 Diopter |
| BKH20C | Clear Magnifiers, 2.0 Diopter |
| BKH20GC | Gray Magnifiers, 2.0 Diopter |
| BKH25C | Clear Magnifiers, 2.5 Diopter |
| BKH25GC | Gray Magnifiers, 2.5 Diopter |

Crews Storm® SAFETY GLASSES offer extreme comfort in a face-flattering design. Ratchet-action temples combined with non-slip rubber head grips create a customized fit for virtually any head size. Wraparound lenses are constructed of lightweight, scratch-resistant polycarbonate for extra toughness. Meets ANSI Z87.1+ requirements. 99.9% UV protection.

| P/N | DESCRIPTION |
|-------|------------------------------------|
| EW107 | Black Frame w/ Clear Anti-Fog Lens |
| EW108 | Black Frame w/ Gray Anti-Fog Lens |

Crews Tomahawk® SAFETY GLASSES provide an affordable alternative in eyeglass comfort, protection, and style. They feature five-position, ratchet-action temples; a wraparound, polycarbonate lens; and integral side shields. Frame is lightweight too, which adds to the comfort. Meets ANSI Z87.1+ requirements. 99.9% UV protection.

| P/N | DESCRIPTION |
|--------|---------------------------|
| EW102 | Black Frame w/ Clear Lens |
| TK112C | Black Frame w/ Gray Lens |



Sleek, Stylish Eye Protection

Nemesis™ SAFETY GLASSES offer a sleek, sporty style that's designed for safety and comfort. Lightweight with flex temples for an effortless fit. Single, wraparound lens offers excellent impact protection too. Comes with a neck cord to keep them handy. Meets ANSI Z87.1+ standards. 99.9% UV protection.



NEMSM

| P/N | DESCRIPTION | EACH |
|----------|---|------|
| NEMBM | Black Frame w/ Blue Mirror Lens | |
| NEMC | Black Frame w/ Clear Lens | |
| NEMIO | Black Frame w/ Indoor/Outdoor Clear Lens | |
| NEMSM | Black Frame w/ Smoke Mirror Lens | |
| → NEMCAF | Black Frame w/ Clear Anti-Fog Lens | |
| → NEMSAF | Black Frame w/ Smoke Mirror Anti-Fog Lens | |

Harley-Davidson® HD800 Series SAFETY GLASSES

provide a new attitude in safety compliance. Its super-lightweight frameless design with one-piece wraparound lens ensures comfortable, all-day wear. Meets ANSI Z87.1-2010 and is certified to the requirements of the CSA Z94.3 standards. 99.9% UV protection. ©2014 H-D. All rights reserved. Manufactured by Honeywell Safety Products under license from Harley-Davidson Motor Co. **WARNING:** Not intended for use when riding a motorcycle. Improper use may result in serious personal injury or death.



Honeywell



HD801SN

| P/N | DESCRIPTION | EACH |
|---------|----------------------------------|------|
| HD801SN | Silver Frame w/ Blue Mirror Lens | |

With **Tacoma® SAFETY GLASSES**, from **Crews**, get low-cost protection without giving up quality, comfort, or durability. Made of strong, lightweight polycarbonate with a one-piece wraparound lens for a wider field of vision and maximum protection. Fits over most personal eyewear. Meets ANSI Z87.1+ requirements. 99.9% UV protection.



EW101

| P/N | DESCRIPTION |
|-------|--------------------------------------|
| EW101 | Black Temples w/ Clear Uncoated Lens |

LAW® OTG (Over The Glass) PROTECTIVE EYEWEAR

features durable dielectric nylon frames with five-position ratcheting temples. They also include an exclusive Duramass® scratch-resistant coating and non-slip temple inserts. Silver temple. Meets ANSI impact standards and blocks 99.99% of harmful UV rays.



→ NEW

OG112AFC

| P/N | DESCRIPTION |
|------------|---------------------|
| → OG110AFC | Clear Anti-Fog Lens |
| → OG112AFC | Gray Anti-Fog Lens |

These economical **SAFETY GOGGLES** feature a comfortable, soft frame; direct ventilation; and a wide one-piece clear polycarbonate lens. Meets ANSI Z87.1+ requirements. 99.9% UV protection.



EW201

| P/N | DESCRIPTION |
|-------|------------------------|
| EW201 | Economy Safety Goggles |

Crews premium **Verdict® SAFETY GOGGLES** can be worn with most half-mask respirators, while fitting over most prescription eyeglasses. Goggles feature a gray PVC frame, clear anti-fog lens, indirect ventilation, and adjustable elastic strap. Meets ANSI Z87.1+ requirements. 99.9% UV protection.



EW241

| P/N | DESCRIPTION | EACH |
|-------|------------------------|------|
| EW241 | Premium Safety Goggles | |



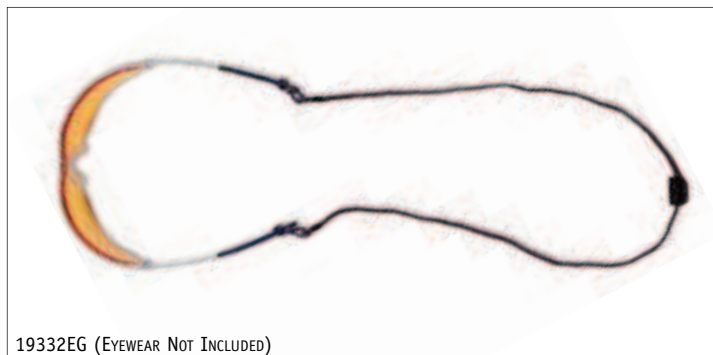

Ergodyne® EYEWEAR LANYARDS feature a slip-fit style that accommodates most eyewear frames. Made of 3mm nylon rope with a single breakaway safety design.

| P/N | DESCRIPTION | EACH |
|---------|------------------------|------|
| 19332EG | Eyewear Lanyard, Black | |

19332EG (EYEWEAR NOT INCLUDED)



MCR Safety's LENS CLEANING STATION is perfect for the care and maintenance of safety eyewear. Containing two boxes of 300 tissues and one 8 oz bottle of anti-fog/anti-static cleaning spray, this station extends the life of protective eyewear by keeping it clean.

| P/N | DESCRIPTION | EACH |
|------|-----------------------|------|
| LCS1 | Lens Cleaning Station | |

LCS1



The **PureFlow 1000 EYEWASH STATION** delivers **Eyesaline®** solution purified, contaminant-free, and physiologically correct from a sealed integrated delivery module. The cartridge has a 24-month shelf life and unit has a 15-minute flush time. Must purchase fluid cartridges separately. Meets ANSI Z358.1.

| P/N | DESCRIPTION | EACH |
|--------|--|--------------|
| 1000ES | PureFlow 1000 (Eyewash Station Only) | |
| 1000FC | PureFlow 1000 Fluid Cartridges, Pkg/2 | |
| RP176 | "Emergency Eye Wash" Sign, 8" x 10" | SEE PAGE 154 |
| PTD176 | "Emergency Eye Wash" 3-D Sign, 18" x 10" | SEE PAGE 154 |

1000ES



RP176



PTD176

Eyesaline® EYEWASH PRODUCTS provide immediate flushing of the eyes with sterile buffered saline solution. Wall stations hold bottles in place for quick, easy access in emergencies. Twist-off tabs mean there are no seals to remove and no leaking caps. Tabs cannot be replaced after removing, indicating product has been used or tampered with. Three-year shelf life.



461ES



462ES

| P/N | DESCRIPTION |
|-------|-------------------------------------|
| 460ES | Single 16 oz Eyesaline Wall Station |
| 461ES | Single 32 oz Eyesaline Wall Station |
| 462ES | Double 32 oz Eyesaline Wall Station |
| 454EB | Replacement 16 oz Eyesaline Bottle |
| 455EB | Replacement 32 oz Eyesaline Bottle |



WELDING APPAREL

From full leather jackets to leather bib aprons and sleeves, **Memphis LEATHER WELDING APPAREL** fits your protective apparel needs perfectly. Jacket and aprons are riveted at all major stress points, while sleeves feature full coverage from above the elbow down to the wrist. Plus all button snaps are anodized to prevent arc flashback. Jacket and aprons also sport various pockets for all of your odds and ends. Cross back straps standard on bib apron. Gray.

| P/N | DESCRIPTION | EACH |
|-------------|--------------------------------------|------|
| 38030MWLMG | Leather Welding Jacket, 30", L | |
| 38030MWXLMG | Leather Welding Jacket, 30", XL | |
| 38142MWMG | Leather Welding Bib Apron, 24" x 42" | |
| 38418MWMG | Leather Welding Sleeves (Pair), 18" | |



38030MWLMG

These flame-retardant **COTTON WELDING SLEEVES**, from **Memphis**, feature 9 oz treated green cotton fabric with 2 1/4" heavy-duty elastic bands at the tops and wrists for a secure, comfortable fit. Sold in pairs. Green.

| P/N | DESCRIPTION | EACH |
|---------|-----------------------------|------|
| 39418MG | Cotton Welding Sleeves, 18" | |
| 39423MG | Cotton Welding Sleeves, 23" | |



39418MG

These economy **Memphis LEATHER WELDING GLOVES** are generously cut in a gunn pattern with welts in the high-stress areas. The **MG4300B** features full-sock linings that are sewn in at the fingertips. The **MG4500** features 4 mil foam and red jersey sock linings. One-piece leather back also adds toughness. Sold in pairs.

| P/N | DESCRIPTION | EACH |
|---------|--|------|
| MG4300B | Leather Welding Gloves, Russet, L | |
| MG4500 | Leather Welding Gloves w/ Dbl Reinforced Palm & Thumb & Kevlar Thread, Blue, L | |



MG4500



MG4950L

Memphis Mustang™ WELDING GLOVES feature all-leather construction with grain cow leather palms and backs plus split leather 4 1/2" gauntlet cuffs. They are also sewn with **Kevlar®** thread for extra toughness. Cream/Russet. Sold in pairs.

| P/N | DESCRIPTION | EACH |
|----------|----------------------------|------|
| MG4950L | Mustang Welding Gloves, L | |
| MG4950XL | Mustang Welding Gloves, XL | |



38505MWMG

LEATHER SHOE PROTECTORS, from **Memphis**, go easily over tops of shoes or boots and use two straps around the ankle and one under the sole for a snug fit. One size. Gray.

| P/N | DESCRIPTION | EACH |
|-----------|-------------------------|------|
| 38505MWMG | Leather Shoe Protectors | |





EP07



EPQD30

HEARING PROTECTION

Easy-to-use **EAR PLUGS** come in a dispenser-style box and are moisture resistant. Ear plugs form a constant and effective Noise Reduction Rating when used as directed. Boxed in individually wrapped pairs.

| P/N | DESCRIPTION | EACH |
|--------|---|------|
| EP07 | Disposable Foam Ear Plug, Uncorded (NRR29), Pkg/200 | |
| EPQD30 | Reusable Ear Plugs, Corded (NRR26), Pkg/100 | |



EMTHHB



EMTHCM

Headband and hard-hat-mounted **EARMUFFS**, for basic hearing protection, are lightweight and durable with soft-sealing cushions and a unique cup design for good sound level reduction. Headband earmuffs have a Noise Reduction Rating of 26 dB, and hard-hat-mounted earmuffs have a 25 dB rating when used as directed. Mounted earmuffs are compatible with **HH1**, **HH2**, and **HH3** hard hats on page 67.

| P/N | DESCRIPTION | EACH |
|--------|---------------------------|------|
| EMTHHB | Headband Earmuffs | |
| EMTHCM | Hard-Hat-Mounted Earmuffs | |



RP9500



RP1730

RESPIRATORY PROTECTION

Disposable **COMFORT MASKS** for relief from nuisance and non-toxic dusts, powders, and pollen. Lightweight with adjustable metal forming strip over nose for comfort.

| P/N | DESCRIPTION | EACH |
|--------|----------------------------|------|
| RP9500 | Nuisance Dust Mask, Pkg/50 | |



RP9200

Disposable **PARTICULATE RESPIRATORS** are maintenance free with soft, smooth inner linings and nose cushions for increased worker comfort. Custom shapes, nose pieces, and head straps offer a superior fit. Collapse-resistant double-shell construction for extended product life. NIOSH certified respirators have a 95% efficiency level.

| P/N | DESCRIPTION | EACH |
|--------|------------------------------------|------|
| RP1730 | N95 Particulate Respirator, Pkg/20 | |

DUAL CARTRIDGE HALF-MASK RESPIRATORS

are masterpieces of design, performance, and comfort. The facepiece has a soft non-allergenic material that seals smoothly and a **Form Guard™** that holds the shape, keeping it clean when it's not in use. Get a perfect fit, thanks to the cradle suspension and adjustable head straps. Cartridges and filters keep a low and swept-back profile, so they don't get in the way of glasses or goggles. Comes in a reusable storage bag, ensuring compliance with OSHA storage requirements. Consult chemical MSDS for proper cartridge use. Mask and cartridges are NIOSH certified.



RPF01



RPG01



RPG95N

| P/N | DESCRIPTION | EACH |
|--------|---|------|
| RP9200 | Half-Mask Respirator, Medium | |
| RP9300 | Half-Mask Respirator, Large | |
| RPF01 | Pre-Filter Retainer, Pkg/2 | |
| RPG01 | Organic Vapor Cartridge, Pkg/2 | |
| RPG03 | Organic Vapor, Acid Gas Cartridge, Chlorine, Hydrogen Chloride, Sulfur Dioxide, Pkg/2 | |
| RPG95N | Pre-Filter (All Particulate Aerosols including oil w/ 95% Efficiency), Pkg/10 | |



HAND PROTECTION

Ergodyne® ProFlex® 710 MECHANICS GLOVES feature soft, flexible, and durable synthetic leather palms, fingers, and reinforced thumb/index finger saddles. PVC palms offer a secure grip and longer wear, while EVA foam palms absorb impacts. Other features include woven elastic cuffs, pull tabs, and micro-injected closures for quick cinching. Machine washable. Black.

| P/N | DESCRIPTION | SIZE | EACH |
|------------|------------------------------|------|------|
| 16144MWGL | ProFlex 710 Mechanics Gloves | L | |
| 16144MWGXL | ProFlex 710 Mechanics Gloves | XL | |



16144MWGL

MCR WORK GLOVES offer a perfect fit for all of your hand protection needs. Heavy duty and rugged, these gloves are ideal for a wide variety of jobs.

| P/N | DESCRIPTION | SIZE | EACH |
|-----------|---|------|------|
| 8808LMG | 7 oz Cotton Canvas, Dotted Work Glove, Natural/Black | L | |
| 9688MMG | 10 ga Cotton/Poly, Flex Tuff Glove w/ Latex Palm, Gray | M | |
| 9688LMG | 10 ga Cotton/Poly, Flex Tuff Glove w/ Latex Palm, Gray | L | |
| 9688XLMG | 10 ga Cotton/Poly, Flex Tuff Glove w/ Latex Palm, Gray | XL | |
| 3130MMG | Split-Leather Work Glove w/ Keystone Thumb, Tan | M | |
| 3130LMG | Split-Leather Work Glove w/ Keystone Thumb, Tan | L | |
| 3130XLMG | Split-Leather Work Glove w/ Keystone Thumb, Tan | XL | |
| 12010LMG | Leather/Canvas Work Glove, Gunn Cut w/ Rubberized Safety Cuff, Gray/Striped | L | |
| 12010XLMG | Leather/Canvas Work Glove, Gunn Cut w/ Rubberized Safety Cuff, Gray/Striped | XL | |



8808LMG



9688LMG



3130LMG



12010LMG

These powder-free **DISPOSABLE NITRILE GLOVES**, from **MCR**, are perfect for people who have latex allergies. Super strong with a secure fit, these gloves provide tactile sensitivity plus protection from bloodborne pathogens. Textured surface (4 mil). Blue.

| P/N | DESCRIPTION | SIZE | EACH |
|----------|------------------------------------|------|------|
| NIPFT102 | Disposable Nitrile Gloves, Pkg/100 | S | |
| NIPFT103 | Disposable Nitrile Gloves, Pkg/100 | M | |
| NIPFT104 | Disposable Nitrile Gloves, Pkg/100 | L | |
| NIPFT105 | Disposable Nitrile Gloves, Pkg/100 | XL | |



NIPFT104

Get dependable, quality hand protection at an affordable price with **MCR DISPOSABLE LATEX GLOVES**. They're easier to pull on, thanks to a thin layer of dusting powder, and come standard with rolled cuffs (5 mil). Natural.

| P/N | DESCRIPTION | SIZE | EACH |
|------|----------------------------------|------|------|
| P103 | Disposable Latex Gloves, Pkg/100 | M | |
| P104 | Disposable Latex Gloves, Pkg/100 | L | |
| P105 | Disposable Latex Gloves, Pkg/100 | XL | |



P105



A Cleaner Way To Clean



KCW180

KCHWM w/
KCHDW475KCHDD w/
KCHDW475

WypAll® WIPERS provide better absorption than a shop rag and come in different thicknesses for different jobs. And since they're disposable, they keep workers healthier and shops cleaner. **WypAll** uses **Hydraknit®** technology to combine excellent absorbing power in a lightweight wiper that is reusable. They also take up less space than rags and install anywhere with a **JUMBO ROLL DISPENSER**.

| P/N | DESCRIPTION | EACH |
|----------|---|------|
| KCW180 | Pop-Up Box Wipers, White, 12 ¹ / ₂ " x 16 ³ / ₄ ", 180 ea Replaces 25 lbs of Scrap Rags | |
| KCHDW475 | Jumbo Roll Wipers, Red, 12 ¹ / ₂ " x 13 ³ / ₈ ", 475 ea Replaces 75 lbs of Scrap Rags | |
| KCHDD | Jumbo Roll Dispenser, 16 ³ / ₄ "L x 33"H x 18 ¹ / ₂ "W | |
| KCHWM | Jumbo Roll Wall Mount Dispenser, 16 ³ / ₄ "L x 8 ³ / ₄ "H x 10 ³ / ₄ "W | |



HANDSAN8



GJS095806

Alcohol-based **Purell® Advanced INSTANT HAND SANITIZER** works in seconds to kill 99.99% of the most common germs that cause illness. And **Purell** can be used anywhere, since no water or towels are needed. Specially formulated with four different skin conditioning agents to leave hands soft without a sticky residue.

| P/N | DESCRIPTION | EACH |
|----------|----------------------------------|------|
| HANDSAN8 | Hand Sanitizer, 8 oz Pump Bottle | |



GJW629804

Gojo HANDCARE/CLEANERS are dermatologist tested and specially formulated to gently remove a variety of soils and effectively cleanse hands.

| P/N | DESCRIPTION | EACH |
|-----------|---|------|
| GJS095806 | Orange Pumice Hand Cleaner w/ Pump Dispenser, 1/2 gal | |
| GJW629804 | Fast Wipes Multi-Purpose Towels, Bucket/130 | |



KCRB200



KCST55

Ideal for all of your toughest tasks, **Scott® TOWELS** are strong, soft, absorbent, and work like a cloth. For a quick solution to any mess, **Rags In A Box** and **Shop Towels** are great for wiping hands, cleaning tools, and absorbing liquids, oil, and grease. For consistent quality and affordability, no other brand beats **Scott**.

| P/N | DESCRIPTION | EACH |
|---------|--|------|
| KCRB200 | Rags In A Box, White, 10" x 13", Box/200 | |
| KCST55 | Shop Towels, Blue, 10 ³ / ₈ " x 11", Roll/55 | |

PROTECTIVE CLOTHING AND RAINWEAR

Protect your clothing with this 36" **DENIM APRON**. Two pockets carry your essentials. One size.

| P/N | DESCRIPTION | EACH |
|---------|-------------|------|
| 39836MG | Denim Apron | |

PROTECTIVE COVERALLS with serged seams, front zipper, and collar. The most popular disposable protective clothing available.

| P/N | DESCRIPTION | SIZE | EACH |
|--------|----------------------|-----------|------|
| 555L | Coverall | L | |
| 555XL | Coverall | XL | |
| 555XXL | Coverall | 2XL | |
| TYBC | Boot Cover, Non-Skid | L/XL | |
| → TYSC | Shoe Cover | Universal | |

→ **More PROTECTIVE COVERALLS Available - Call for Pricing.**



39836MG



555L



TYBC



MCR's 16" STEEL TOE PVC BOOTS feature a heavy-duty, over-the-sock design and cleated soles with traction grips. They're 100% waterproof with polyester linings and kick-off lugs for easy on and off. They're flexible, too, for excellent comfort and abrasion resistance. Black.

| P/N | DESCRIPTION | SIZE | EACH |
|-------|--------------|------|------|
| STB10 | 16" PVC Boot | 10 | |
| STB11 | 16" PVC Boot | 11 | |
| STB12 | 16" PVC Boot | 12 | |
| STB13 | 16" PVC Boot | 13 | |
| STB14 | 16" PVC Boot | 14 | |



STB10

These over-the-shoe 17" **RUBBER SLUSH BOOTS** are cotton-lined with black cleated outsoles. Top straps and buckles provide easy-on comfort and fit too. Yellow.

| P/N | DESCRIPTION | SIZE | EACH |
|------------|----------------|------|------|
| BYR10010RC | 17" Slush Boot | 10 | |
| BYR10011RC | 17" Slush Boot | 11 | |
| BYR10012RC | 17" Slush Boot | 12 | |
| BYR10013RC | 17" Slush Boot | 13 | |
| BYR10014RC | 17" Slush Boot | 14 | |
| BYR10015RC | 17" Slush Boot | 15 | |
| BYR10016RC | 17" Slush Boot | 16 | |



BYR10012RC

SCHOONER II PONCHOS come with an attached hood and side snap closures. Made of .35mm PVC with polyester fabric base for heavy-duty splash situations. Yellow.

| P/N | DESCRIPTION | SIZE | EACH |
|--------|--------------------|-----------|------|
| 2000RC | Schooner II Poncho | 52" x 80" | |



2000RC

3-PIECE RAINSUITS include a detachable hood, jacket, and fly-front bib overalls. Features include double heat welded seams, take up snaps on sleeves, two flapped jacket pockets, and non-conductive hardware. Rainsuits are made of waterproof .35mm PVC/ polyester. Yellow.

| P/N | DESCRIPTION | SIZE | EACH |
|----------|------------------|------|------|
| RW353M | 3-Piece Rainsuit | M | |
| RW353L | 3-Piece Rainsuit | L | |
| RW353XL | 3-Piece Rainsuit | XL | |
| RW353XXL | 3-Piece Rainsuit | 2XL | |
| RW3533XL | 3-Piece Rainsuit | 3XL | |
| RW3534XL | 3-Piece Rainsuit | 4XL | |



RW353L





TV15

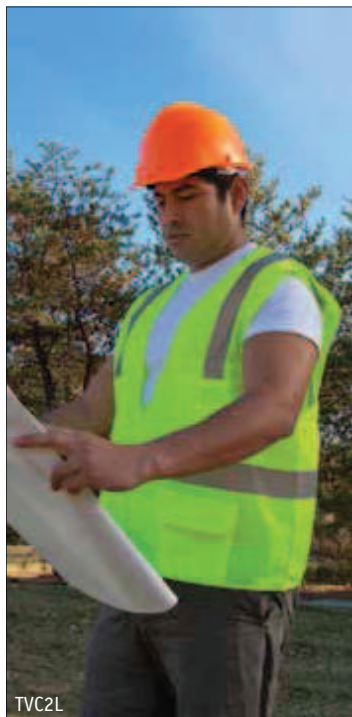

TVC2L

GENERAL-PURPOSE SAFETY VESTS are made from 100% polyester mesh fabric with a matching tricot binding. Comes with 1" silver reflective stripes for high visibility. Features include a hook-and-loop front and elastic-strapped sides. 19" x 48".

| P/N | DESCRIPTION | EACH |
|------|-------------------------------------|------|
| TV15 | General-Purpose Safety Vest, Orange | |
| TV55 | General-Purpose Safety Vest, Lime | |

Class 2 **SURVEYOR'S VESTS** feature 100% polyester mesh/solid fabric with zipper closures. Contrasting 2" glass-bead reflective tape can be found on the waist and shoulders. Six pockets—two chest, two inside, and two flap with hook-and-loop closures—are fitted around the vests. ANSI 107 Certified. Lime.

| P/N | DESCRIPTION | SIZE | EACH |
|---------|-----------------|---------|------|
| TVC2S | Surveyor's Vest | S/M | |
| TVC2L | Surveyor's Vest | L/XL | |
| TVC2XXL | Surveyor's Vest | 2XL/3XL | |
| TVC24XL | Surveyor's Vest | 4XL/5XL | |

WARNING TAPES

Our **BARRICADE TAPE** is made of 2.5 mil polyethylene and comes in 3" x 1,000' rolls for easy handling and storage.

| P/N | DESCRIPTION | EACH |
|--------|------------------------------------|------|
| SLYCC | "Caution", Yellow | |
| SLYDNE | "Caution Do Not Enter", Yellow | |
| SLYPL | "Police Line Do Not Cross", Yellow | |
| SLYFL | "Fire Line Do Not Cross", Yellow | |
| TR38 | "Danger Do Not Enter", Red | |

→ **More BARRICADE TAPE Available - Call for Pricing.**



SLYFL



TR38



TH42003



TH1000

Dispense barricade tape quickly, safely, and efficiently with our

BARRICADE TAPE DISPENSER or **TAPE HOLDER**.

The **TH42003** dispenser can hold 1,000' of 2, 3, or 4 mil tape, is made of polyethylene plastic with notches to secure tape, and cuts a serrated edge for easy dispensing. The **TH1000** holder dispenses 1,000' of 2" or 3" barricade tape and includes a steel safety blade for smooth, fast cuts.

| P/N | DESCRIPTION | EACH |
|---------|--------------------------|------|
| TH42003 | Barricade Tape Dispenser | |
| TH1000 | Barricade Tape Holder | |

AISLE MARKING TAPE is made of tough scuff-resistant vinyl plastic, combined with a strong self-adhesive. Great for aisle marking, pipe coding, and many other uses. Rolls are 2" x 108'.

| P/N | DESCRIPTION | EACH |
|--------|----------------------------|------|
| YAT704 | Aisle Marking Tape, Yellow | |

STRIPED WARNING TAPE is made of self-adhesive PVC with a laminated clear film for maximum resistance to traffic, abrasion, and many chemicals. Rolls are 2" x 54'.

| P/N | DESCRIPTION | EACH |
|--------|------------------------------------|------|
| BY7502 | Striped Warning Tape, Black/Yellow | |



YAT704



BY7502



FALL PROTECTION

Basic **Workman® FULL-BODY HARNESS** for fall protection. Features **Qwik-Fit™** chest and leg buckles and a back D-ring. This lightweight harness meets or exceeds CSA, ANSI, and OSHA standards. 400 lb capacity.

| P/N | DESCRIPTION | SIZE | EACH |
|---------|-------------------|----------|------|
| FPHNSTD | Full-Body Harness | Standard | |
| FPHNXL | Full-Body Harness | XL | |

Workman® ENERGY-ABSORBING LANYARDS are lightweight with a pack-type shock absorber. They are designed to limit the maximum arrest forces to less than 900 lbs with a maximum deployment distance of 42". Both models are 6', single leg. The **FP6LLS** comes with a double-locking snap at both ends, and the **FP6LLR** comes with a double-locking snap and rebar hook. Meets ANSI A10.32 and OSHA regulations. 310 lb capacity.

| P/N | DESCRIPTION | EACH |
|--------|------------------------------|------|
| FP6LLS | Lanyard w/ Double Snap | |
| FP6LLR | Lanyard w/ Snap & Rebar Hook | |

Workman® PFL LANYARD features a solid design with a fast-acting brake mechanism. It also comes with rugged, impact-absorbing bumpers and a 12' web lifeline with a locking snaphook. 400 lb capacity.

| P/N | DESCRIPTION | EACH |
|---------|-------------|------|
| FP12PFL | PFL Lanyard | |



LOCKOUT/TAGOUT

Safety **LOCKOUT HASPS** provide a safe, proven method of locking out energy sources. Two models are available: the red heavy-duty nylon style or the aluminum scissors type. The nylon model is flexible, unbreakable, dielectric, and heat and cold resistant. The aluminum models have rubber-dipped handles and are available with two different jaw-opening sizes. Both models accommodate up to six padlocks.

| P/N | DESCRIPTION | EACH |
|------|-------------------------------|------|
| MS01 | Lockout Hasp, Nylon | |
| 0G80 | Lockout Hasp, 1" Aluminum | |
| 0G82 | Lockout Hasp, 1 1/2" Aluminum | |



We carry a full range of **BALL** and **BUTTERFLY VALVE LOCKOUTS**, including **BS03D**—the largest ball valve lockout available. All are made of strong polypropylene plastic, which is highly resistant to cracking and abrasion. Fully dielectric and resistant to extreme temperature changes (-50°F–360°F). Ball valve lockout **BS01** can be used to lock valves in the open or closed position. Red.

| P/N | DESCRIPTION | EACH |
|-------|-----------------------------------|------|
| BS01 | Ball Valve Lockout, 3/8"–1 1/4" | |
| BS02 | Ball Valve Lockout, 1 1/2"–2 1/2" | |
| BS03D | Ball Valve Lockout, 2"–8" | |
| BS04D | Universal Butterfly Valve Lockout | |





ML480

Ideal for tight spaces and insulated pipes, **Master Lock® ROTATING GATE VALVE LOCKOUTS** come in various diameters to fit over different size valve handles. They can be locked to protect against accidental opening and feature tough yet lightweight dielectric **Zenex™** thermoplastic construction, which easily withstands chemicals and temperature extremes. Their unique, patented rotating design is also what makes it easy to fit them in tight spaces. Hi-vis safety labels come in English, French, and Spanish, and the center knockout can be removed to fit over a rising stem gate valve.

| P/N | DESCRIPTION | EACH |
|-------|--------------------------------|------|
| ML480 | Gate Valve Lockout, 1"-3" Dia | |
| ML481 | Gate Valve Lockout, 2"-5" Dia | |
| ML482 | Gate Valve Lockout, 4"-6½" Dia | |



MLS3910

The **Master Lock® PRESSURIZED GAS VALVE LOCKOUT** fits most pressurized gas valve handles up to 3" in diameter. This patented product is designed to work with the valve guard in place too. It also works with multiple lockout hasps and accepts any **Master Lock** or **American Lock®** safety padlocks.

| P/N | DESCRIPTION | EACH |
|---------|---|------|
| MLS3910 | Pressurized Gas Valve Lockout (Lock Not Included) | |



WHEEL VALVE LOCKOUTS

V-Safe® WHEEL VALVE LOCKOUTS consist of two half moons that completely cover the valve handwheel. Made of strong dielectric polypropylene plastic, making them highly resistant to cracking, abrasion, and extreme temperature changes (-50°F-360°F). Easily modified for rising-stem-type valves too. Red.

| P/N | DESCRIPTION | EACH |
|-------|------------------------------------|------|
| VS02 | Wheel Valve Lockout, Up to 2½" Dia | |
| VS04 | Wheel Valve Lockout, 2½"-5" Dia | |
| VS06 | Wheel Valve Lockout, 5"-6½" Dia | |
| VS09D | Wheel Valve Lockout, 6½"-10" Dia | |
| VS13D | Wheel Valve Lockout, 10"-14" Dia | |



CB03



CB01

C-Safe® CIRCUIT BREAKER LOCKOUTS are made of tough molded plastic. Available to fit single and double pole breakers. **CB03** can be used with all single pole breakers without the through hole. **CB01** fits most major brands of electrical circuit breakers with a padlock hole through the breaker toggle. The **CB04** will fit most major brands of electrical circuit breakers. **CB02** fits double pole breakers.

| P/N | DESCRIPTION | EACH |
|------|--|------|
| CB03 | Single Pole Lockout for Toggles w/o Hole | |
| CB01 | Single Pole Lockout for Toggles w/ Hole | |
| CB04 | Double Pole Lockout w/o Crossbar | |
| CB02 | Double Pole Lockout w/ Crossbar | |



CB04



CB02



LOCKOUT/TAGOUT CENTERS offer a convenient way to locate and store lockout items. Made of double-molded polystyrene with hanging lock hooks. Small center measures 24" x 18". The large center measures 35" x 24".

NOTE: Tags do not have grommets.

| CONTENTS DESCRIPTION | P/N | P/N | P/N | P/N |
|--------------------------|--------|--------|--------|-------|
| Wheel Valve Lockouts | VS02 | VS04 | VS06 | VS09D |
| Large Center | 2 | 1 | 1 | 1 |
| Small Center | 2 | 1 | 1 | - |
| Ball Valve Lockouts | BS01 | BS02 | - | - |
| Large Center | 1 | 1 | - | - |
| Small Center | 1 | - | - | - |
| Electrical Plug Lockouts | LP110 | LP550 | - | - |
| Large Center | 2 | 1 | - | - |
| Small Center | 2 | 1 | - | - |
| Lockout Tags, Pkg/25 | ELA250 | ELA290 | ELA255 | - |
| Large Center | 1 | 1 | 1 | - |
| Small Center | - | 1 | 1 | - |
| Hasps | MS01 | OG80 | - | - |
| Large Center | 6 | 2 | - | - |
| Small Center | 4 | 1 | - | - |
| Padlocks | L40 | - | - | - |
| Large Center | 4 | - | - | - |
| Small Center | 1 | - | - | - |

| P/N | DESCRIPTION | EACH |
|------|------------------------------|------|
| LTC1 | Lockout/Tagout Center, Small | |
| LTC2 | Lockout/Tagout Center, Large | |



LTC1



LTC2



L051

LOCKOUT STATION PANEL for storing locks, padlocks, and tags. Unit measures 11" x 14" and will hold the items pictured (not included).

| P/N | DESCRIPTION | EACH |
|------|-----------------|------|
| L051 | Lockout Station | |

LOCKOUT TAGS measure 3" x 5 3/4" and are made of rugged, stain- and mildew-resistant .020 mil styrene. Grommets are standard on tags for greater strength. All tags have the "DANGER" heading, striped red border, and come with zip ties. The textured surface allows you to write your name and other important information easily.

| P/N | DESCRIPTION | EACH |
|--------|--------------------------|------|
| ELA290 | "Do Not Operate", Pkg/25 | |
| ELA255 | "Do Not Open", Pkg/25 | |
| ELA250 | "Do Not Start", Pkg/25 | |



ELA250 FRONT & BACK

GROUP LOCK BOX is used for work-team lockout situations, where multiple employees are working on the same lockout. All keys are stored in the lock box. The group leader or foreman then locks the box until the job is complete and all group members are cleared from the work area. Solid steel construction with red enamel finish. Lock not included.

| P/N | DESCRIPTION | L X H X D | EACH |
|-------|----------------|-------------------|------|
| GLB01 | Group Lock Box | 11" x 6" x 4 1/2" | |



GLB01

The **E-Safe® "LOCK-A-PLUG"** is a practical, positive-locking system that prevents accidental reconnection by unauthorized personnel. Made of dielectric polypropylene plastic, it resists extreme temperature changes (up to 300°F). Features a sliding closure with integrated multiple lockout. The **LP110** will accept plugs up to 3 1/4"L x 1 3/4"W x 1 3/4"D, with a maximum cable diameter of 1/2". **LP550** will accept plugs up to 6 3/4"L x 3"W x 3"D, with a maximum cable diameter of 1".

| P/N | DESCRIPTION | EACH |
|-------|-------------------------|------|
| LP110 | Lock-A-Plug, 110VAC | |
| LP550 | Lock-A-Plug, 220/550VAC | |



LP110





L40

PADLOCKS

LAMINATED PADLOCK, from **Master Lock®**, features a four-pin cylinder nickel-plated steel body and hardened steel shackle. Shackle is 1/4" thick with an inside measure 7/8" x 13/16". All locks are keyed differently. Ideal for group lock box and high-security applications.

| P/N | DESCRIPTION | EACH |
|-----|---------------------------------|------|
| L40 | Laminated Padlock, 3/4" Shackle | |



M12L

PADLOCK for cabinets and other security requirements. Corrosion-resistant, all-brass shackle, and keyed-alike.

| P/N | DESCRIPTION | SEE PAGE 33 |
|------|-----------------------|-------------|
| M12L | Padlock, 5/8" Shackle | |



ML500KA

Master Lock® is a name synonymous with top-quality padlocks. The keyed-alike **BREAKAWAY STEEL PADLOCK** has a 1 3/4"-wide laminated steel body for superior strength and comes with two keys, a steel shackle for strong cut resistance, and a warded locking mechanism that helps minimize jamming from foreign matter, like dirt and grime. And it's rustproof for extended wear.

| P/N | DESCRIPTION | SEE PAGE 33 |
|---------|--|-------------|
| ML500KA | Keyed-Alike Breakaway Steel Padlock, 1 3/16" Shackle | |



SBL66

BREAKAWAY BRASS PADLOCK for securing cabinets and other equipment. Designed to be opened with a key (included), but can be broken away in an emergency.

| P/N | DESCRIPTION | SEE PAGE 33 |
|-------|---------------------------------------|-------------|
| SBL66 | Breakaway Brass Padlock, 7/8" Shackle | |

Abus' ECONOMY PADLOCK with nickel plated steel shackle for cabinets. Keyed-alike. Blue.

| P/N | DESCRIPTION | SEE PAGE 33 |
|--------|-------------------------------|-------------|
| 1635AB | Economy Padlock, 3/4" Shackle | |



1635AB



PPL

Plastic PADLOCK must be cut or broken for access. Red.

| P/N | DESCRIPTION | SEE PAGE 34 |
|-----|-----------------------------------|-------------|
| PPL | Red Plastic Padlock, 3/4" Shackle | |



1106R



1107B

American Lock® ALUMINUM PADLOCKS are spark and corrosion resistant, keyed differently with five-pin rekeyable cylinders, and case-hardened boron alloy steel shackles.

| P/N | DESCRIPTION | EACH |
|-------|--|------|
| 1106B | Aluminum Padlock, 1 1/2" Shackle, Blue | |
| 1106R | Aluminum Padlock, 1 1/2" Shackle, Red | |
| 1107B | Aluminum Padlock, 3" Shackle, Blue | |
| 1107R | Aluminum Padlock, 3" Shackle, Red | |



SAFES

Keep valuables and important documents under lock and key, or code, with any of these **Honeywell SAFES**. Different models fit different needs, from vehicle to home security.

NOTE: Keys are located in the Styrofoam at the box bottom.

| P/N | DESCRIPTION | EACH |
|-------|---|------|
| S1101 | 30 Minute Fire Document Chest, 0.15 cu. ft. | |
| S6104 | Steel Security Box, 0.17 cu. ft. | |
| S5101 | Steel Security Box, 0.35 cu. ft. | |
| S5113 | Steel Security Box, 0.50 cu. ft. | |
| S2101 | Brigade Series Steel Fire & Security Safe | |
| S6114 | Car Safe w/ Removable Key | |



S1101

SAFETY MATS

Safewalk-Light™ FLOOR SAFETY MAT proves that it's possible to combine anti-fatigue with drain-through capabilities. Mat is 1/2" thick, easy-to-clean, and recommended for use in medium-to-heavy-duty oily, wet, and dry areas. Black.

| P/N | DESCRIPTION | EACH |
|------------|-----------------------------|------|
| WSCT35BKCM | Safewalk-Light Mat, 3' x 5' | |



WSCT35BKCM

INDUSTRIAL DECK PLATE MATTING is durable and features a slip-resistant surface. Mat is 9/16" thick, resistant to most common fluids and chemicals, and comes with beveled edges and yellow borders for greater visual awareness and improved safety. For use in medium-to-heavy-duty dry areas. Black/Yellow.

| P/N | DESCRIPTION | EACH |
|------------|------------------------------------|------|
| CD0035YBCM | Industrial Deck Plate Mat, 3' x 5' | |



CD0035YBCM

STORAGE

Sure-Grip® EX SAFETY STORAGE CABINETS, by **Justrite®**, are redesigned with a padlockable handle, reflective labeling, and safety shelving. They're made to store flammable liquids safely. The three-point lock has a fail-safe closing mechanism, dual vents with flame arresters, leveling feet, and a 2" leakproof sill in the base. Some units come with a fusible link-actuated door that's self-closing at 165°F. 30 gal cabinets have one shelf; larger cabinets have two. FM, OSHA, and NFPA approved. Yellow.

| P/N | DESCRIPTION | WEIGHT | H X W X D | EACH |
|-------------|---|---------|-----------------|------|
| DDPJR893000 | 30 gal Cabinet Manual Doors | 221 lbs | 44" x 43" x 18" | |
| DDPJR893020 | 30 gal Cabinet Self-Closing Doors - Uniform Fire Code | 223 lbs | 44" x 43" x 18" | |
| DDPJR893300 | 30 gal "Short" Cabinet Manual Doors | 204 lbs | 35" x 36" x 24" | |
| DDPJR894500 | 45 gal Cabinet Manual Doors | 299 lbs | 65" x 43" x 18" | |
| DDPJR894520 | 45 gal Cabinet Self-Closing Doors - Uniform Fire Code | 301 lbs | 65" x 43" x 18" | |
| DDPJR894580 | 45 gal Cabinet Self-Closing Sliding Door - Uniform Fire Code | 301 lbs | 65" x 43" x 18" | |
| DDPJR896000 | 60 gal Cabinet Manual Doors | 366 lbs | 65" x 34" x 34" | |
| DDPJR896020 | 60 gal Cabinet Self-Closing Doors - Uniform Fire Code | 368 lbs | 65" x 34" x 34" | |
| DDPJR899000 | 90 gal Cabinet Manual Doors | 421 lbs | 65" x 43" x 34" | |
| DDPJR899020 | 90 gal Cabinet Self-Closing Doors - Uniform Fire Code | 423 lbs | 65" x 43" x 34" | |
| DDPJR29937 | Replacement Steel Shelf for 30, 40, & 45 gal Cabinets | | | |

➔ **More SAFETY STORAGE CABINETS Available - Call for Pricing.**



DDPJR893020



DDPJR894520





DDPJR893400

Justrite® WALL MOUNT/BENCH CABINETS store small containers without taking up floor space and have the same great features as the **Safety Storage Cabinets**. 20 gal cabinet has five adjustable shelves and 17 gal has one. NFPA and OSHA approved. Yellow.

| P/N | DESCRIPTION | WEIGHT | H X W X D | EACH |
|--------------|--|---------|-----------------|------|
| DDPJR8917008 | 17 gal Wall/Bench Manual Doors | 153 lbs | 24" x 43" x 18" | |
| DDPJR893400 | 20 gal Wall/Bench Manual Doors - FM | 205 lbs | 44" x 43" x 12" | |

Justrite® UNDERCOUNTER CABINETS mount flush with other cabinetry and come with vent openings in their back wall. Stores 22 gallons of flammable liquids. Self-closing doors activate automatically at 165°F. FM, OSHA, and NFPA approved. Yellow.

| P/N | DESCRIPTION | WEIGHT | H X W X D | EACH |
|-------------|---|---------|-----------------|------|
| DDPJR892300 | 22 gal Undercounter Manual Doors | 190 lbs | 35" x 35" x 22" | |
| DDPJR892320 | 22 gal Undercounter Self-Closing Doors - Uniform Fire Code | 192 lbs | 35" x 35" x 22" | |

Justrite® "COMPAC" CABINETS fit almost anywhere and provide protection where space is limited. Self-closing doors activate at 165°F. FM, OSHA, and NFPA approved. Yellow.

| P/N | DESCRIPTION | WEIGHT | H X W X D | EACH |
|-------------|---|---------|--|------|
| DDPJR891200 | 12 gal Compac Manual Doors | 120 lbs | 35" x 23 ¹ / ₄ " x 18" | |
| DDPJR891220 | 12 gal Compac Self-Closing Doors - Uniform Fire Code | 122 lbs | 35" x 23 ¹ / ₄ " x 18" | |
| DDPJR891500 | 15 gal Compac Manual Doors | 154 lbs | 44" x 23 ¹ / ₄ " x 18" | |

Justrite® PIGGYBACK/COUNTERTOP CABINETS

are designed to mount on top of standard 30 and 45 gal safety cabinets. They can be used singly or stacked to provide expanded or segregated storage of flammables. These cabinets are also wall mountable with manual or self-closing doors. Designed and manufactured to the same specifications as **Justrite's** standard-size safety storage cabinets with one adjustable shelf (except 12 gal). NFPA and OSHA approved. Yellow.

| P/N | DESCRIPTION | WEIGHT | H X W X D | EACH |
|-------------|---|---------|-----------------|------|
| DDPJR890400 | 4 gal Countertop Manual Door | 62 lbs | 22" x 17" x 17" | |
| DDPJR890420 | 4 gal Countertop Self-Closing Door - Uniform Fire Code | 64 lbs | 22" x 17" x 17" | |
| DDPJR891300 | 12 gal Piggyback Manual Doors | 129 lbs | 18" x 43" x 18" | |
| DDPJR891700 | 17 gal Piggyback Manual Doors | 148 lbs | 24" x 43" x 18" | |



DDPJR891200



DDPJR890420

CLASS III STORAGE CABINETS, from **Justrite®**, provide central storage and organization for your paints, inks, or other combustible liquids. Features 18-gauge double-wall construction with insulating air barrier, three-point lock with fail-safe closing mechanism, dual vents with built-in flame arresters, adjustable (1¹/₂") leveling feet, and a 2" leakproof sill in base of cabinet. Self-closing fusible-link-actuated door releases automatically at 165°F. Cabinets come with three adjustable shelves. FM, OSHA, and NFPA approved. Red.

| P/N | DESCRIPTION | WEIGHT | H X W X D | EACH |
|-------------|--|---------|-----------------|------|
| DDPJR893011 | 40 gal Class III Manual Doors | 223 lbs | 44" x 43" x 18" | |
| DDPJR893031 | 40 gal Class III Self-Closing Doors - Uniform Fire Code | 225 lbs | 44" x 43" x 18" | |



DDPJR893011



Heavy-Duty Flammable Fuel Storage



TYPE I SAFETY CANS, from **Justrite®**, are an economical choice for flammable liquids. All have a self-closing, leak-proof lid to prevent ruptures from pressure build-up and control vapors and spills. Sidewalls are strengthened with high-grade coated steel for “bumper guard” protection. To avoid misuse and reduce the potential for incompatible mixtures, different color cans differentiate liquids and are affixed with warning labels that have an extra-large ID zone for user labeling of contents. Meets OSHA and NFPA requirements and are certified by FM, UL, and ULC. Carb compliant TUV certified.

| P/N | DESCRIPTION | WEIGHT | H X DIA (OUTER) | EACH |
|--------------|--------------------------|--------|-------------------|------|
| JR7110100 | 1 gal Type I, Red | 4 lbs | 11" x 9 1/2" | |
| DDPJR7110300 | 1 gal Type I, Blue | 4 lbs | 11" x 9 1/2" | |
| DDPJR7110200 | 1 gal Type I, Yellow | 4 lbs | 11" x 9 1/2" | |
| DDPJR7110400 | 1 gal Type I, Green | 4 lbs | 11" x 9 1/2" | |
| JR7120100 | 2 gal Type I, Red | 5 lbs | 13 3/4" x 9 1/2" | |
| JR7120300 | 2 gal Type I, Blue | 5 lbs | 13 3/4" x 9 1/2" | |
| JR7120200 | 2 gal Type I, Yellow | 5 lbs | 13 3/4" x 9 1/2" | |
| JR7125100 | 2 1/2 gal Type I, Red | 6 lbs | 11 1/2" x 11 3/4" | |
| JR7125300 | 2 1/2 gal Type I, Blue | 6 lbs | 11 1/2" x 11 3/4" | |
| JR7125200 | 2 1/2 gal Type I, Yellow | 6 lbs | 11 1/2" x 11 3/4" | |
| JR7150100 | 5 gal Type I, Red | 8 lbs | 16 7/8" x 11 3/4" | |
| JR7150300 | 5 gal Type I, Blue | 8 lbs | 16 7/8" x 11 3/4" | |
| JR7150400 | 5 gal Type I, Green | 8 lbs | 16 7/8" x 11 3/4" | |
| JR7150200 | 5 gal Type I, Yellow | 8 lbs | 16 7/8" x 11 3/4" | |

CHOOSING THE RIGHT SAFETY CAN

Red is used, and OSHA accepted, for flammable liquids. **Blue** is often used to store kerosene. **Yellow** cans usually store diesel fuel, and **Green** cans are mostly used to store oil.

Justrite® FLAMMABLE WASTE STORAGE CABINETS

are designed for temporary on-site storage of flammable or combustible wastes. Features double-wall construction, adjustable leveler feet, three-point door lock with key, and a 2" leakproof sill. Cabinets are designed for vertical storage of any 55 gal drum equipped with a **Justrite** pump. Each cabinet comes with a single shelf. NFPA and OSHA approved. White.

| P/N | DESCRIPTION | WEIGHT | H X W X D | EACH |
|--------------|---|---------|-----------------|------|
| DDPJR8930053 | Holds 6, 5 gal Cans Manual Doors - FM | 221 lbs | 44" x 43" x 18" | |
| DDPJR8962053 | Holds 1, 55 gal Drum Manual Doors - FM | 391 lbs | 65" x 34" x 34" | |
| DDPJR8991053 | Holds 2, 55 gal Drums Manual Doors | 610 lbs | 65" x 59" x 34" | |



DDPJR8991053

It's crucial to protect important papers and publications. And nothing secures them better than **Justrite's DOCUMENT STORAGE BOX**. Impervious to dirt and moisture, this handy storage unit is tough, boasting rustproof polyethylene construction. There's also heavy-duty double-sided tape for easy installation. Unit features a flip top with easy snap latches for instant access too.

Storage Box measures 12 1/2"H x 10 1/4"W x 2 1/4"D (outside) and 11 1/2"H x 8 3/4"W x 1 5/8"D (inside). Red.

| P/N | DESCRIPTION | EACH |
|---------|-----------------------------------|------|
| JR23303 | Document Storage Box | |
| JR23310 | (2) MSDS Label & (2) Blank Labels | |



JR23303, JR23310





DDPJ23007

Justrite® CYLINDER LOCKERS safely secure LPG and oxygen cylinders, deterring theft and unauthorized access. Constructed of 100% welded aluminum. Will not rust, corrode, or discolor. Comes with a solid aluminum roof panel that slants to the back to shed water and ice. Complies with NFPA 58 and OSHA 1910.110 requirements.

| P/N | DESCRIPTION | WEIGHT | H X W X D | EACH |
|-----------|----------------------------|---------|--------------------------------|------|
| DDPJ23001 | Horizontal Cylinder Locker | 79 lbs | 33 $\frac{1}{2}$ " x 30" x 32" | |
| DDPJ23002 | Horizontal Cylinder Locker | 97 lbs | 49 $\frac{1}{2}$ " x 30" x 32" | |
| DDPJ23003 | Horizontal Cylinder Locker | 114 lbs | 65" x 30" x 32" | |
| DDPJ23004 | Horizontal Cylinder Locker | 178 lbs | 49 $\frac{1}{2}$ " x 60" x 32" | |
| DDPJ23005 | Horizontal Cylinder Locker | 211 lbs | 65" x 60" x 32" | |
| DDPJ23006 | Vertical Cylinder Locker | 102 lbs | 65" x 30" x 32" | |
| DDPJ23007 | Vertical Cylinder Locker | 187 lbs | 65" x 60" x 32" | |
| DDPJ23008 | Combo Vert/Horiz Locker | 198 lbs | 65" x 60" x 32" | |

The **"I'M EASY" FUNNEL**, by **Justrite®**, is easy to attach, easy to fill, and easy to pour into small openings. A hinged design allows the user to fill the can without removing the funnel. Made of durable polypropylene. Yellow.

| P/N | DESCRIPTION | WEIGHT | H X DIA (OUTER) | EACH |
|----------|--|--------|--|------|
| JR11202Y | "I'm Easy" Funnel Fits Type I Steel Cans 1 gal & Up | 1 lb | 11 $\frac{1}{4}$ " x 1 $\frac{1}{2}$ " | |



JR11202Y



JR11202Y IN USE

Justrite's TYPE I OVAL SAFETY CAN is for carrying flammable liquids. Features high-density polyethylene construction with stainless steel fittings. Dent-proof and puncture-resistant polyethylene stands up to tough acids and corrosives. Designed and manufactured with a current-carrying carbon insert embedded in the rib of the container, preventing the creation of an arc. Red.

| P/N | DESCRIPTION | WEIGHT | H X W X D | EACH |
|----------|--------------|---------------------|--|------|
| JR14160D | 1 gal Type I | 2 $\frac{1}{2}$ lbs | 12 $\frac{3}{4}$ " x 7 $\frac{5}{8}$ " x 4 $\frac{5}{8}$ " | |



JR14160D



JR7250130

Justrite's TYPE II SAFETY CANS are for carrying flammable liquids. Leak-proof terne plate (lead/tin coated steel) construction resists solvents, acids, and alkalis. Features a **Safe-Squeeze®** trigger and built-in flexible metal hose for spill-free pouring, swinging handle design for easy handling, free-flow flame arrester to stop flashback ignition, and a relief mechanism that vents pressure at 5 psi. UL listed and FM approved. Red.

| P/N | DESCRIPTION | WEIGHT | H X DIA | EACH |
|-----------|---|--------|---|------|
| JR7210120 | 1 gal Type II, $\frac{5}{8}$ " x 9" Hose | 7 lbs | 10 $\frac{1}{2}$ " x 9 $\frac{1}{2}$ " | |
| JR7220120 | 2 gal Type II, $\frac{5}{8}$ " x 9" Hose | 8 lbs | 13 $\frac{1}{4}$ " x 9 $\frac{1}{2}$ " | |
| JR7225130 | 2 $\frac{1}{2}$ gal Type II, 1" x 9" Hose | 8 lbs | 12" x 11 $\frac{3}{4}$ " | |
| JR7250120 | 5 gal Type II, $\frac{5}{8}$ " x 9" Hose | 10 lbs | 17 $\frac{1}{2}$ " x 11 $\frac{3}{4}$ " | |
| JR7250130 | 5 gal Type II, 1" x 9" Hose | 10 lbs | 17 $\frac{1}{2}$ " x 11 $\frac{3}{4}$ " | |

TYPE II TRANSPORT SAFETY CAN, from **Justrite®**, has the same great features as the standard **Type II Cans** plus heavy-duty roll bar construction protecting the fill and pouring mechanisms from damage, while providing handholds. Dual fusible linked bracket with easy-to-operate hand mechanism protects against content spillage in shock-load conditions. Meets DOT HM-181 requirements and is FM approved. Red.

| P/N | DESCRIPTION | WEIGHT | H X DIA | EACH |
|-------------|------------------------------------|--------|---|------|
| DDPJ2350130 | 5 gal DOT Safety Can, 1" x 9" Hose | 15 lbs | 17 $\frac{1}{4}$ " x 11 $\frac{3}{4}$ " | |



DDPJ2350130



DISPENSING BOTTLE features low-density polyethylene construction. Squeezing the bottle produces a fine stream of liquid. Stem can be shaped as needed to dispense into tight areas.

| P/N | DESCRIPTION | H X DIA | EACH |
|---------|-----------------------|--------------------------------------|------|
| JR14009 | Squeeze Bottle, 16 oz | 7 ¹ / ₂ " x 3" | |

The **DRUM WRENCH**, from **Justrite®**, is made of rugged, non-sparking, and corrosive-resistant brass alloy. Fits any of seven alternate 2" or 3/4" styles commonly used on drums. Handle design protects the hand when in use.

| P/N | DESCRIPTION | WEIGHT | EACH |
|----------|-------------|---------|------|
| JR08805D | Drum Wrench | 2.3 lbs | |



JR14009



JR08805D

DISPOSAL

Justrite® OILY WASTE CANS feature terne plate (lead/tin coated steel) construction and foot pedals for hands-free operation. Ventilated base helps prevent combustion too. UL listed and FM approved. OSHA compliant. Red.

| P/N | DESCRIPTION | WEIGHT | H X DIA | EACH |
|-----------|-----------------------|----------|--|------|
| JR09100 | 6 gal Oily Waste Can | 9.5 lbs | 15 ⁷ / ₈ " x 11 ⁷ / ₈ " | |
| JR09300 | 10 gal Oily Waste Can | 12.5 lbs | 18 ¹ / ₄ " x 14" | |
| JR09500 | 14 gal Oily Waste Can | 15.5 lbs | 20 ¹ / ₄ " x 16" | |
| DDPJ09700 | 21 gal Oily Waste Can | 22 lbs | 23 ³ / ₁₆ " x 18 ³ / ₄ " | |



JR09100



JR09100 IN USE

Justrite's DRUM FUNNEL features a large 10³/₄" mouth for fast-dumping with minimal spills and a hinged fusible-link-actuated cover. Steel funnel comes with 6" brass flame arrester and 2" NPS thread. FM approved. EPA and OSHA compliant. Red.

| P/N | DESCRIPTION | H X DIA | EACH |
|-----------|-------------|--|------|
| DDPJ08207 | Drum Funnel | 10" x 10 ³ / ₄ " | |



DDPJ08207



JR26750

Justrite® DRUM COVERS provide an inexpensive way to convert open-top 55 gal steel drums into fire-safe receptacles for combustible trash. Only a screwdriver and wrench are needed for attachment or removal. Features a replaceable fusible link assembly that automatically shuts the cover in the event of fire. Covers are steel with a chemically-resistant powder coat paint. Fits drums 22¹/₂" to 22³/₄" in diameter. Red.

| P/N | DESCRIPTION | WEIGHT | EACH |
|---------|-------------|------------------------------------|------|
| JR26750 | Drum Cover | 13 ¹ / ₂ lbs | |

Smokers Cease-Fire™ CIGARETTE BUTT RECEPTACLES are a safe, attractive method of cigarette disposal. Oxygen-restricting design quickly extinguishes butts, reducing the risk of fire. Hooded 1¹/₂" opening keeps out the rain and other types of trash. Made of high-density flame-retardant polyethylene, these receptacles won't rust, dent, crack, or peel. Twist-on lid and removable galvanized steel liner pail provide trouble-free cleaning. Includes tie-down notches for additional security. Fire tested and approved by Factory Mutual (FM). Measures 38¹/₂"H x 16¹/₂"Dia.

| P/N | DESCRIPTION | EACH |
|-----------|---|------|
| JR26800BK | Cigarette Butt Receptacle, Deco Black | |
| JR26800BG | Cigarette Butt Receptacle, Adobe Beige | |
| JR26800T | Cigarette Butt Receptacle, Terra Cotta | |
| JR26800P | Cigarette Butt Receptacle, Pewter Gray | |
| JR26800G | Cigarette Butt Receptacle, Forest Green | |



JR26800BK, JR26800BG, JR26800T, JR26800P, JR26800G





FA13014



FA12024



FA14924

FIRST AID KITS AND CABINETS

Our **FIRST AID METAL CABINETS** have been specially designed to provide the most complete first aid protection available in each particular size. The balanced assortment of supplies will handle most first aid needs. Each cabinet is dust proof and wall mountable.

| P/N | DESCRIPTION | H X W X D | EACH |
|---------|---------------------------|---|------|
| FA12014 | 2-Shelf, Empty w/ Pockets | 12" x 18 ¹ / ₄ " x 5 ¹ / ₂ " | |
| FA13014 | 3-Shelf, Empty w/ Pockets | 16 ¹ / ₄ " x 15 ¹ / ₄ " x 5 ⁵ / ₈ " | |
| FA14014 | 4-Shelf, Empty w/ Pockets | 22 ² / ₈ " x 15 ¹ / ₄ " x 5 ⁵ / ₈ " | |
| FA12024 | 2-Shelf, Full | 12" x 18 ¹ / ₄ " x 5 ¹ / ₂ " | |
| FA13924 | 3-Shelf, Full | 16 ¹ / ₄ " x 15 ¹ / ₄ " x 5 ⁵ / ₈ " | |
| FA14924 | 4-Shelf, Full | 22 ² / ₈ " x 15 ¹ / ₄ " x 5 ⁵ / ₈ " | |
| FA14329 | 4-Shelf, Restaurant, Full | 28 ¹ / ₄ " x 19 ¹ / ₄ " x 6 ⁵ / ₈ " | |

CABINET CONTENTS

| | FA12024 | FA13924 | FA14924 | FA14329 |
|--|---------|---------|---------|---------|
| Alcohol Wipes (50) | - | 1 | 1 | - |
| Antiseptic Wipes (20) | - | 1 | 1 | - |
| Ammonia Inhalants (10) | 1 | - | - | - |
| Antiseptic Spray, 2 oz | 1 | 1 | 1 | 1 |
| Burn Spray, 2 oz | 1 | 1 | 1 | 1 |
| Cold Spray, 4 oz | 1 | - | 1 | 1 |
| Hydrogen Peroxide Spray, 2 oz | - | - | 1 | 1 |
| Adhesive Bandages, 3/4" x 3" (100) | 1 | - | - | - |
| Adhesive Bandages, 7/8" x 3" (50) | - | - | 1 | - |
| Adhesive Bandages, 1" x 3" | - | 50 | 75 | 50 |
| Visi-Blue Adhesive Bandage, 1" x 3" (40) | - | - | - | 1 |
| Elastic Strip Bandages, 7/8" x 3" (50) | - | 1 | - | - |
| Extra-Long Strip Bandages (25) | - | 1 | 1 | 1 |
| Finger Tip Bandages (40) | 1 | 1 | 1 | - |
| Visi-Blue Finger Tip Bandages (30) | - | - | - | 1 |
| Knuckle Bandages (40) | 1 | 1 | 1 | - |
| Visi-Blue Knuckle Bandages (30) | - | - | - | 1 |
| Non-Sterile Triangular Bandage | - | 1 | 1 | 1 |
| Sterile Non-Stick Pads, 2" x 3" (10) | - | - | 1 | 1 |
| Sterile Gauze Pads, 2" x 2" | 25 | 10 | 10 | - |
| Sterile Gauze Pads, 3" x 3" | - | 10 | 10 | 10 |
| Sterile BloodStopper Compress | 1 | 1 | 1 | 1 |
| Burn & Blister Relief Dressings (6) | - | - | - | 1 |
| Elastic Wrap, 2" (Ace Type) | - | 1 | 1 | - |
| Non-Sterile Clean Wrap, 2" | - | 1 | 1 | - |
| Non-Sterile Clean Wrap, 3" | - | - | 1 | - |
| Tri-Cut Adhesive Tape, 15 yds | 1 | 1 | 1 | 1 |
| Medi-Rip, 2" | - | - | - | 1 |
| Finger Cots, Blue, Large (144) | - | - | - | 1 |
| Eyewash, 4 oz | 1 | 1 | 1 | 1 |
| Flushing Solution, 8 oz | 1 | 1 | 1 | - |
| Emergency Medical Gloves, Pair (2) | 1 | 1 | 1 | 1 |
| Instant Ice Pack, Large | 1 | 1 | 1 | 1 |
| Antacid Tablets (100) | - | - | - | 1 |
| Anti-Diarrheal Caplets (12) | - | - | - | 1 |
| Cough Drop Lozenges (50) | - | - | - | 1 |
| Cold Tablets (100) | - | - | - | 1 |
| Ibuprofen Tablets (100) | 1 | - | - | 1 |
| Non-Aspirin Tablets (100) | - | 1 | 1 | 1 |
| PainAway Tablets (100) | - | 1 | 1 | 1 |
| PepTum Tablets (36) | - | - | 1 | - |
| CPR Microshield Mouth Barrier | - | 1 | 1 | - |
| NexTemp Thermometers (4) | - | - | 1 | 1 |
| POCKET FILLS | | | | |
| Heavy Fabric Bandages, 2" x 3" (5) | 1 | - | 1 | 1 |
| Butterfly Wound Closures | - | 5 | 10 | 10 |
| First Aid Cream (5) | - | 1 | 1 | 1 |
| Hydrocortisone Itch Relief Cream (5) | - | 1 | 1 | 1 |
| Triple Antibiotic Ointment (10) | - | 1 | 1 | 1 |
| Burn Relief Gel | - | 5 | 6 | 5 |
| Hand Sanitizer Gel (5) | - | - | 1 | 1 |
| Skin Lotion (5) | - | 1 | 1 | 1 |
| Dental Relief Cream (5) | - | - | 1 | 1 |
| Biofreeze Cold Therapy (5) | - | 1 | - | - |
| Lip Aid (5) | - | 1 | 1 | 1 |
| TheraTears Eye Drops (4) | - | 1 | - | - |
| CPR Face Shield | - | - | 1 | 1 |
| Kit Scissors | 1 | 1 | 1 | 1 |
| Disposable Tweezers | - | 1 | 1 | 1 |
| Splinter Out Splinter Removers (2) | - | 1 | - | - |
| First Aid Guide | - | 1 | 1 | 1 |



Our **FIRST AID RESPONDER KIT** easily accommodates trauma kit supplies in a lightweight, easy-to-carry soft pack that protects valuable supplies from dirt and grime. Interior expandable side straps keep supplies organized.

| P/N | DESCRIPTION | L X H X W | EACH |
|---------|-------------------------|----------------|------|
| FA21624 | First Aid Responder Kit | 13" x 10" x 8" | |

KIT CONTENTS

| | |
|---------------------------------------|------------------------------------|
| Alcohol Wipes (50) | Sterile Trauma Dressing, 10" x 30" |
| Antiseptic Wipes (20) | Sterile BloodStopper Compress |
| Cohesive Bandage, 3" x 5 yds | Tri-Cut Adhesive Tape, 15 yds |
| Elastic Strip Bandages, 7/8" x 3"(50) | Emergency Survival Wrap, 52" x 84" |
| Triangular Bandage | Eye & Skin Wash, 16 oz |
| Conforming Gauze Dressing, 2" x 5 yds | Emergency Medical Gloves, Pair (2) |
| Conforming Gauze Dressing, 3" x 5 yds | Instant Ice Pack, Small |
| Large Patch, 2" x 3" (25) | CPR Mask |
| Sterile ABD Pad, 5" x 9" | Bandage Scissors |
| Sterile Gauze Pads, 4" x 4" (10) | Kit Tweezers |
| Burn Dressing, 4" x 4" | EMT Utility Scissors |
| | First Aid Guide |



FA21624

FIRST AID SIGNS come in a variety of sizes and styles to help meet your particular job requirements. Durable and fade resistant, these signs mount to almost anything—indoors or out.

| P/N | DESCRIPTION | L X H |
|----------|---|-----------|
| G261 | Glow-in-the-Dark AED Label | 6" x 8" |
| PTD261 | "Automated External Defibrillator" 3-D Sign | 5" x 6" |
| BL144 | "First Aid Station" Arrow Sign | 8" x 12" |
| RP144 | "First Aid" Sign | 8" x 10" |
| PTD262 | "First Aid" 3-D Sign | 5" x 6" |
| FAPOSTER | First Aid Poster | 24" x 18" |

| P/N | DESCRIPTION | L X H |
|-------|-----------------------------|---------|
| BL157 | "First Aid Kit Inside" Sign | 4" x 4" |



G261



BL144



RP144



PTD262

FIRST AID VEHICLE AND UNITIZED KITS

FIRST AID KITS contain essential first aid products for the care of occupational injury and illness. Meets or exceeds OSHA regulations and ANSI Z308.1-2009 standards.

| P/N | DESCRIPTION | H X W X D | EACH |
|---------|-------------------------|---|------|
| FA20030 | 25-Person First Aid Kit | 7 ³ / ₁₆ " x 10 ¹¹ / ₁₆ " x 2 ³ / ₈ " | |

KIT CONTENTS

| | |
|-----------------------------------|--|
| Alcohol Wipes (8) | Conforming Gauze Dressing, 2" x 5 yds |
| Antiseptic Wipes (10) | Sterile Gauze Pads, 4" x 4" (2) |
| Ammonia Inhalants (10) | Waterproof Adhesive Tape, 1/2" x 5 yds |
| Burn Jel Packets (6) | Eyewash, 1 oz |
| Triple Antibiotic Ointment (6) | Disposable Latex Gloves, Pair (2) |
| Adhesive Bandages (16) | Ice Pack, Small, Boxed |
| Fingertip Flexible Bandages (10) | Tylenol Caplets (2) |
| Triangular Bandage | Kit Tweezers |
| ABD Pad, 5" x 9" | Wire Scissors |
| Absorbent Gauze Pads, 3" x 3" (4) | First Aid Guide |



BL157



FAPOSTER



FA20030





FA206007

This **DELUXE 25-PERSON FIRST AID KIT** has a greater variety and more products than most other first aid kits, enabling personnel to respond to emergencies quicker and more efficiently. Meets or exceeds OSHA regulations and ANSI Z308.1-2009 standards.

| P/N | DESCRIPTION | H X W X D | EACH |
|----------|--------------------------------|---------------|------|
| FA206007 | Deluxe 25-Person First Aid Kit | 7" x 10" x 3" | |

KIT CONTENTS

| | |
|------------------------------------|----------------------------------|
| Antiseptic Wipes (10) | Non-Stick Pads, 3" x 4" (2) |
| Antibiotic Cream (10) | Adhesive Tape, 1/2" x 2 1/2" yds |
| Burn Cream (6) | Absorbent Compress, 32 sq. in. |
| PVP Iodine Swabs (2) | Instant Cold Compress |
| Adhesive Bandages, 2" x 3" (5) | Nitrile Gloves, Pair (2) |
| Adhesive Bandages, 1" x 3" (30) | Blood Lancets (2) |
| Woven Knuckle Bandages (5) | Eye Wash, 1 oz |
| Woven Fingertip Bandages (5) | Kit Forceps, Plastic |
| Triangular Bandage | Kit Scissors |
| Sterile Gauze Dressing, 2" x 6 yds | CPRotector Barrier |
| Sterile Gauze Pads, 3" x 3" (4) | Biohazard Bag w/ Tie |
| Eye Pads (2) | First Aid Facts Guide |
| Non-Stick Pads, 2" x 3" (2) | |



FA20424

FIRST AID KITS contain essential first aid products for the care of occupational injury and illness.

| P/N | DESCRIPTION | H X W X D | EACH |
|----------|---|-----------------------|------|
| FA20424 | #16 Standard Vehicle First Aid Kit, Metal | 7" x 9 1/2" x 2 1/2" | |
| FA20924 | #36 Deluxe Vehicle First Aid Kit, Metal | 9 1/2" x 14" x 2 1/2" | |
| FAS40127 | Handyman Econo First Aid Kit, Plastic | 5" x 8" x 3" | |

KIT CONTENTS

| | FA20424 | FA20924 | FAS40127 |
|-----------------------------------|---------|---------|----------|
| Antiseptic Wipes (4) | - | - | 1 |
| Ammonia Inhalants | - | 10 | - |
| Antiseptic Spray, 2 oz | - | 1 | - |
| Burn Spray, 2 oz | - | 1 | - |
| Adhesive Bandages, 1" x 3" (16) | 1 | 1 | 1 |
| Elastic Strip Bandages, 7/8" x 3" | 10 | 50 | - |
| Triangular Bandage | - | 1 | - |
| Flex Gauze, 2" | - | - | 1 |
| Sterile Gauze Pads, 2" x 2" (25) | - | 1 | - |
| Sterile Gauze Pads, 3" x 3" | 4 | - | 3 |
| Sterile BloodStopper Compress | 1 | 1 | - |
| Non-Sterile Clean Wrap, 2" | 1 | 1 | - |
| Adhesive Tape | 1 | 1 | 1 |
| Eyewash, 4 oz | 1 | 1 | - |
| Emergency Medical Gloves, Pair | 1 | 1 | 1 |
| Instant Ice Pack, Small | 1 | - | 1 |
| Instant Ice Pack, Large | - | 1 | - |
| Tylenol Caplets (2) | - | - | 2 |
| Triple Antibiotic Cream (4) | - | - | 1 |
| Kit Scissors | - | 1 | - |
| Kit Tweezers | - | 1 | - |



FA20924



FAS40127



UNITIZED VEHICLE FIRST AID KIT

| P/N | DESCRIPTION | H X W X D | EACH |
|---------|-------------------------------------|----------------------|------|
| FA20174 | #10 Unitized First Aid Kit, Plastic | 5 1/2" x 8" x 2 1/2" | |

KIT CONTENTS

- Alcohol Wipes (10)
- Antiseptic Wipes (10)
- Insect Sting Relief Wipes (10)
- Triple Antibiotic Ointment (10)
- Adhesive Bandages, 1" x 3" (16)
- Elastic Strip Bandages, 7/8" x 3" (10)
- Knuckle Bandages (10)
- Sterile Gauze Pads, 3" x 3" (4)
- Bandage Compress, 4"
- Emergency Medical Gloves, Pair



FA20174

UNITIZED FIRST AID KITS come with color-coded unitized packages to keep first aid products clean and easy to identify. Each kit is portable, easy to mount, and they're dust and moisture resistant.

| P/N | DESCRIPTION | H X W X D | EACH |
|---------|---|---------------|------|
| FA20674 | #16 Unitized Econo First Aid Kit, Plastic | 7" x 10" x 3" | |

KIT CONTENTS

- Alcohol Wipes (10)
- Antiseptic Wipes (10)
- Insect Sting Relief Wipes (10)
- Ammonia Inhalants (10)
- Triple Antibiotic Ointment (10)
- Adhesive Bandages, 1" x 3" (16)
- Elastic Strip Bandages, 7/8" x 3" (10)
- Finger Tip Bandages (10)
- Knuckle Bandages (10)
- Sterile Gauze Pads, 3" x 3" (4)
- Bandage Compress, 4"
- Emergency Medical Gloves, Pair (2)
- First Aid Guide



FA20674

Our **DELUXE SNAKE BITE KIT** has everything to treat venomous snake bites. Packed in a water-resistant plastic carrying case for safe keeping.

| P/N | DESCRIPTION | H X W X D | EACH |
|----------|-----------------------|----------------------|------|
| FA182060 | Deluxe Snake Bite Kit | 4" x 2 3/4" x 1 1/4" | |

KIT CONTENTS

- Certi-Suction Pump w/ Adapters
- Antiseptic BZK Towelette
- PVP Iodine Wipe-Ups (2)
- 1" x 3" Plastic Adhesive Strips (2)
- Venomous Bite Wipe-Ups (2)
- Ammonia Inhalant
- Tourniquet
- Cutting Blade



FA182060





FA250100

CPR/BIOHAZARD KITS AND SUPPLIES

The **BODILY FLUID CLEAN-UP KIT** provides economical protection against communicable diseases, containing the necessary items to protect the areas of the body most likely to come in contact with infectious agents.

| P/N | DESCRIPTION | EACH |
|----------|---------------------------|------|
| FA250100 | Bodily Fluid Clean-Up Kit | |

KIT CONTENTS

Clean-Up Absorbent Pack
 Disposable Apron
 Disposable Goggles w/ Top & Side Shields
 Medical-Grade Disposable Gloves, Pair
 Scoop (Waterproof Michelman Coated)
 Scraper (Waterproof Michelman Coated)
 Biohazard Red Plastic Bags w/ Twist Ties (2)
 Pour Bottle Chlorine Concentrate, 8 oz
 Disposable Paper Towels (3)
 Chlorhexidine Towelettes (2)
 Disposable Shoe Covers
 Disposable, High-Performance Splash Protector (99% Filtration)



FA200912

This **BLOODBORNE PATHOGEN/PERSONAL PROTECTION KIT** meets OSHA standards. It comes with eye and mouth protection for safer CPR as well as a waste bag for safe, easy clean up. Kit is wall mountable and made of polypropylene for durability.

| P/N | DESCRIPTION | H X W X D | EACH |
|----------|-------------------------|--|------|
| FA200912 | Bloodborne Pathogen Kit | 8 ³ / ₈ " x 9" x 2 ¹ / ₂ " | |

KIT CONTENTS

Antiseptic Cleansing Wipe (3)
 Disposable Gown w/ Full Sleeves
 Disposable Bonnet
 Disposable Shoe Covers, Pair
 Eye Shield w/ Ear Loop Mask
 Fluid Control Solidifier Pack, 21gm
 Biohazard Scoop
 Biohazard Bags, 24" x 24" (2)
 Clear Plastic Bags, 8" x 12" (2)
 Disposable Clean-Up Towels (3)
 Germicidal Wipes, 5" x 8" (2)
 Exam-Quality Vinyl Gloves, Pair (2)
 Bodily Fluid Pick-Up Guide
 Twist Ties (2)
 CPR Pack (1): CPR One-Way Face Shield (1), Exam Quality Vinyl Gloves (2), Antiseptic Wipes (3), All Latex-free.



FA216083

Incineration-safe, these **DISPOSABLE BIOHAZARD BAGS** are double sealed at the bottom to help prevent breakthroughs.

Plus each bag is printed with the universal biohazard symbol and "INFECTIOUS WASTE" in English/Spanish. Bags hold 7–10 gal each.

The **SHARPS BIOHAZARD CONTAINER** is the ideal solution for biohazard containment. Easily holds bio bags and syringes. Container is puncture resistant, leak-proof, and nestable. It also comes with a needle remover and translucent lid that seals shut when full. OSHA compliant.

| P/N | DESCRIPTION | EACH |
|----------|---|------|
| FA216083 | Disposable Biohazard Bags, Pkg/25 | |
| FA70211 | Sharps Biohazard Disposal Container, 1 qt | |



FA70211



BANDAGES

These durable **BANDAGES** are designed to hold up under the most difficult conditions. They are not affected by grease, oil, water, or dirt. Ventilated to promote healing, these flexible bandages feature a non-stick pad in many shapes and sizes.

| P/N | DESCRIPTION |
|---------|--|
| FA44254 | Woven Bandage, 7/8" x 3", Pkg/50 |
| FA31064 | Plastic Strip Bandage, 1" x 3", Pkg/75 |
| FA43044 | Fingertip Woven Bandage, Pkg/40 |
| FA43124 | Fingertip Woven Bandage, Large, Pkg/25 |
| FA44424 | Woven Patch, Large, 2" x 3", Pkg/25 |
| FA43244 | Knuckle Woven Bandage, Pkg/40 |
| FA43724 | Extra-Long Strip Bandage, Pkg/25 |

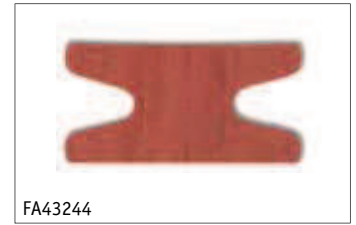

BLUE METAL DETECTABLE ADHESIVE BANDAGES

come in a highly visible blue fabric and contain a metallized film in the wound pad for metal detectability. A special hypoallergenic adhesive helps bandages stick to even moist skin, yet the **PTFE** coated pad won't stick to the wound.

| P/N | DESCRIPTION |
|----------|---|
| FA032540 | Visi-Blue MD Foam Strips, 1" x 3", Pkg/40 |
| FA032730 | Visi-Blue MD Foam Knuckles, Pkg/30 |
| FA032630 | Visi-Blue MD Foam Fingertips, Pkg/30 |



ADHESIVE TAPE, WRAPS, AND GAUZE

ADHESIVE TAPE, WRAPS, and COMPRESS.

| P/N | DESCRIPTION |
|----------|---|
| FA80060 | 1/2" x 5 yds Waterproof Adhesive Tape |
| FA240032 | 1" x 2 1/2 yds Waterproof Adhesive Tape, Pkg/12 |
| FA80424 | Waterproof Tri-Cut Tape |
| FA70010 | Cotton Tip Applicators, Pkg/100 |
| FA82020 | Cohesive Bandage, 2" x 5 yds |
| FA82620 | Elastic Bandage, 2" |
| FA82630 | Elastic Bandage, 3" |
| FA180614 | Triangular Bandage |
| FA72810* | ABD Pad, 5" x 9" |
| FA73450 | Sterile Trauma Dressing, 10" x 30" |

*WHILE QUANTITIES LAST!



GAUZE PADS

| P/N | DESCRIPTION |
|---------|-------------------------------------|
| FA70614 | Sterile Gauze Pads, 2" x 2", Pkg/10 |
| FA70624 | Sterile Gauze Pads, 2" x 2", Pkg/25 |
| FA70814 | Sterile Gauze Pads, 3" x 3", Pkg/10 |
| FA70824 | Sterile Gauze Pads, 3" x 3", Pkg/25 |
| FA71014 | Sterile Gauze Pads, 4" x 4", Pkg/10 |
| FA72220 | Conforming Gauze, 2" x 5 yds |
| FA72230 | Conforming Gauze, 3" x 5 yds |
| FA72240 | Conforming Gauze, 4" x 5 yds |



See Page 92 for Unitized Items.





FA111155



FA119260



FA113524, FA113534



FA115034, FA115044



FA115255



FA121200



FA119310



UNITIZED ITEMS

MEDICATIONS

GENERIC MEDICATIONS provide a high-quality alternative to costlier name brands. **Buffered Aspirin** is a specially formulated analgesic with 5 grains of aspirin, buffered for sensitive stomachs and hyperacidity. Sugar- and salt-free.

| P/N | DESCRIPTION |
|-----------|--|
| FA111830 | Back Pain Relief, Pkg/80 |
| FA111155 | Aspirin, Non-Buffered, Pkg/100 |
| FA111334 | Maximum Strength Non-Aspirin, Pkg/100 |
| FA111434 | Ibuprofen, Pkg/100 |
| FA111444 | Ibuprofen, Pkg/250 |
| FA111534 | Pain Away, Pkg/100 |
| FA111544 | Pain Away, Pkg/250 |
| FA119260 | Allergy Relief, Pkg/20 |
| FA112034 | Pseudoephedrine-Free Cold Tablets, Pkg/100 |
| FA112044 | Pseudoephedrine-Free Cold Tablets, Pkg/250 |
| FA112234 | Sine-Eez Sinus Tablets, Pkg/100 |
| FA112245 | Sine-Eez Sinus Tablets, Pkg/250 |
| FA112434 | Pseudoephedrine-Free Decongestant Tablets, Pkg/100 |
| FA112444* | Pseudoephedrine-Free Decongestant Tablets, Pkg/250 |
| FA113524 | Cherry Cough Drops, Box/50 |
| FA113534 | Cherry Cough Drops, Box/125 |
| FA115034 | Antacid Tablets, Pkg/100 |
| FA115044 | Antacid Tablets, Pkg/250 |
| FA121800* | Alka Seltzer Generic, Pkg/36 |
| FA119310 | Peptum, Pkg/36 |
| FA323483 | Sore Throat Lozenges, Pkg/18 |
| FA115255 | Heat Relief Electrolyte, Box/250 |

*WHILE QUANTITIES LAST!

NAME BRAND MEDICATIONS

| P/N | DESCRIPTION |
|----------|-------------------------------|
| FA121600 | Alka Seltzer Original, Pkg/36 |
| FA121700 | Pepto Bismol Tablets, Pkg/48 |
| FA121200 | Aleve, Pkg/100 |

UNITIZED ITEMS

| P/N | DESCRIPTION |
|-----------|--|
| FA182304 | First Aid Nitrile Gloves, 2 Pair |
| FA180004 | Plastic Strip Bandage 1" x 3", Pkg/16 |
| FA180074 | Woven Bandage, 7/8" x 3", Pkg/10 |
| FA180614 | Triangular Bandage |
| FA180220* | Adhesive Tape, 1/2" x 2 1/2 yds, Pkg/2 Rolls |
| FA181420 | Eye Pads, Pkg/4 |
| FA181200 | Burn Jel, Pkg/6 |
| FA182224 | CPR Pack: "CPRotector" & Gloves |
| FA181024* | Wire Splint |
| FA440* | Emergency Tourniquet |
| FA91014 | Instant Ice Pack, Small |
| FA180100 | Butterfly Closures, Pkg/16 |
| FA180520 | Gauze, 2" x 6 yds, Pkg/2 |
| FA180924 | Compress, 36" x 36" |
| FA181620 | Alcohol Swabs, Pkg/10 |
| FA181664 | Antiseptic Towelettes, Pkg/10 |
| FA181860 | PVP Iodine Wipes, Pkg/10 |
| FA181820 | Ammonia Inhalant, Pkg/10 |
| FA182014 | Sting Relief, Pkg/10 |

*WHILE QUANTITIES LAST!



MISCELLANEOUS FIRST AID

These powder-free **DISPOSABLE NITRILE GLOVES**, from **MCR**, are perfect for people who have latex allergies. Super strong with a secure fit, these gloves provide tactile sensitivity plus protection from bloodborne pathogens. Textured surface (4 mil). Blue.

| P/N | DESCRIPTION | SIZE | EACH |
|----------|------------------------------------|------|------|
| NIPFT102 | Disposable Nitrile Gloves, Pkg/100 | S | |
| NIPFT103 | Disposable Nitrile Gloves, Pkg/100 | M | |
| NIPFT104 | Disposable Nitrile Gloves, Pkg/100 | L | |
| NIPFT105 | Disposable Nitrile Gloves, Pkg/100 | XL | |



NIPFT104

Get dependable, quality hand protection at an affordable price with **MCR DISPOSABLE LATEX GLOVES**. They're easier to pull on, thanks to a thin layer of dusting powder and come standard with rolled cuffs (5 mil). Natural.

| P/N | DESCRIPTION | SIZE | EACH |
|------|----------------------------------|------|------|
| P103 | Disposable Latex Gloves, Pkg/100 | M | |
| P104 | Disposable Latex Gloves, Pkg/100 | L | |
| P105 | Disposable Latex Gloves, Pkg/100 | XL | |



P105

These **LATEX FINGER GUARDS** are ideal for food service work.

| P/N | DESCRIPTION | SIZE |
|-----------|-----------------------|------|
| FA260030* | Finger Guard, Plastic | L |
| FA318320 | Finger Cots, Pkg/144 | M |
| FA318330 | Finger Cots, Pkg/144 | L |

*WHILE QUANTITIES LAST!



FA318320

Purell® HAND SANITIZERS are America's #1 instant hand sanitizer, featuring a complete and innovative product line that includes individually wrapped wipes and gel. Alcohol based, they work in seconds to kill 99.99% of most common germs that cause illness. Use **Purell** anywhere, since no water or towels are needed. Specially formulated with moisturizers to leave hands soft without a sticky residue.

| P/N | DESCRIPTION | EACH |
|----------|---|------|
| FA34400 | Sanitizing Wipes, Individually Wrapped, Pkg/100 | |
| FA34410 | Sanitizing Wipes, Canister/175 | |
| HANDSAN8 | Hand Sanitizer, 8 oz Pump Bottle | |



FA34400



FA34410

Bio Med Wash®, an all-natural, biocompatible sterile **FIRST AID WASH**, is invaluable in the initial washing of skin that has come into contact with irritating chemicals, such as gasoline, pepper spray, and plant toxins, as well as eyes irritated by foreign particles, heavy smoke, dust, or perspiration. Contains 100% **Bio-Logic Aqua®** tissue-culture-grade water, proven to have the ideal content to maximize moisture absorption and promote healing. Great for chemical and manufacturing plants, first aid kits, schools, and offices. And a valuable addition for firefighters, police officers, medics, and military personnel.

| P/N | DESCRIPTION | EACH |
|----------|--------------------|------|
| FA130630 | Bio Med Wash, 3 oz | |



HANDSAN8



FA130630





FA103040



FA102430



FA100014

ANTISEPTICS and OINTMENTS.

| P/N | DESCRIPTION |
|----------|--|
| FA103040 | QR Plus Blood Stopper w/ Applicator, Pkg/2 |
| FA50424 | Alcohol Wipes, Pkg/50 |
| FA50004 | Antiseptic Wipes, Pkg/20 |
| FA050800 | Sani-Dex Hand Wipes, Pkg/100 |
| FA102430 | Lip Aid, Bag/10 |
| FA100014 | Triple Antibiotic Ointment, Pkg/25 |
| FA100414 | Hydrocortisone Cream, Pkg/25 |
| FA101214 | First Aid Cream, Pkg/25 |
| FA050840 | Sani-Cloth Germ Cloth, 5" x 8", Pkg/50 |
| FA051030 | Antiseptic Hand Sanitizer, 9gm, Pkg/10 |



FA050840



FA051030



FA213019

BUG REMEDIES

| P/N | DESCRIPTION |
|----------|----------------------------------|
| FA213019 | Insect Sting Swabs, Box/10 |
| FA61100 | Extra-Strength Itch Relief, 2 oz |



FA050510, FA050220



FA063034



FA91014

MEDICATED SPRAYS

| P/N | DESCRIPTION |
|----------|------------------------------------|
| FA050510 | Alcohol Pump Spray, 2 oz |
| FA050220 | Hydrogen Peroxide Pump Spray, 2 oz |
| FA061020 | Antiseptic Pump Spray, 2 oz |
| FA4017 | Burn Pump Spray, 2 oz |
| FA4016 | Antiseptic Pump Spray, 2 oz |
| FA063034 | Cold Aerosol Spray, 4 oz |
| FA064034 | Blood Stopper Aerosol Spray, 3 oz |



FA4032



FA234014



FA94000

HOT/COLD PACKS

| P/N | DESCRIPTION |
|-----------|-------------------------------------|
| FA91014 | Instant Ice Pack, Small, Boxed |
| FA4032 | Instant Ice Pack, Large |
| FA234014* | Instant Hot Pack |
| FA94000 | Reusable Hot/Cold Compress, 6" x 9" |

*WHILE QUANTITIES LAST!

FIRST AID INSTRUMENTS

| P/N | DESCRIPTION |
|----------|--|
| FA150940 | First Aid Kit Scissors |
| FA5054 | Dumont Splinter Tweezers, 5" w/ Case |
| FA150080 | Safe-Tweez Disposable Tweezer |
| FA5051 | Tweezers, Kit |
| FA150620 | Splinter-Out 10 Probes/Reclosable Plastic Case |
| FA5053 | Eye Magnet & Loop w/ Case |
| FA151110 | Nextemp Disposable Thermometer, Pkg/4 |
| FA151400 | Disposable Penlight |



FA5054



FA5053

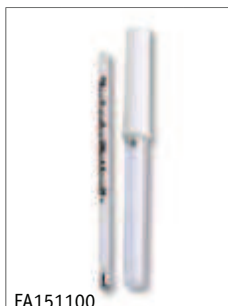

FA151100

Space® Brand COMPACT EMERGENCY BLANKET

comes in a small package, fitting easily in a pocket, glove compartment, or first aid kit. This tough, durable blanket utilizes space-age technology to fight off cold, rain, wind, and sun, and it's ideal for treating hypothermia or shock. Made of vacuum-deposited metal with a polyester film surface, blanket can reflect radar or be used as a signal mirror. Measures 84" x 56".

| P/N | DESCRIPTION | EACH |
|--------|-------------------|------|
| FA9926 | Emergency Blanket | |



FA9926



The **PURE FLOW 1000** delivers **Eyesaline®** solution purified, contaminant-free, and physiologically correct from a sealed integrated delivery module. The cartridge has a 24-month shelf life. Must purchase fluid cartridges separately. Meets ANSI Z358.1-2009.

| P/N | DESCRIPTION | EACH |
|--------|--|------|
| 1000ES | Pure Flow 15 Min. (Eyewash Station Only) | |
| 1000FC | Pure Flow 1000 Fluid Cartridges, Pkg/2 | |



1000ES In Use



460ES

Eyesaline® EYEWASH PRODUCTS

| P/N | DESCRIPTION |
|-------|-------------------------------------|
| 460ES | Single 16 oz Eyesaline Wall Station |
| 461ES | Single 32 oz Eyesaline Wall Station |
| 462ES | Double 32 oz Eyesaline Wall Station |
| 454EB | Replacement 16 oz Eyesaline Bottle |
| 455EB | Replacement 32 oz Eyesaline Bottle |

EYE CARE PRODUCTS include eye drops for quick, soothing relief from minor eye irritations; disposable eye cups for washing out particles in the eye; and **TheraTears®** for exceptional relief of dry, tired, irritated eyes.

| P/N | DESCRIPTION |
|----------|---|
| FA130824 | Personal Eyewash, 8 oz |
| FA131600 | Eye Cups, Vial/6 |
| FA13000 | TheraTears Eye Lubricants, Pkg/4 |
| RP176 | "Emergency Eye Wash" Sign, 8" x 10" |
| PTD176 | "Emergency Eye Wash" 3D Sign, 18" x 10" |

*WHILE QUANTITIES LAST!



FA131600



FA13000



RP176



PTD176

BURN RELIEF

Water-Jel® FIRE BLANKETS and **WRAPS** offer a one-step system for emergency first aid on a burn victim. Available in three sizes, wraps cover a victim's limb or torso, while the blankets completely cover a person, up to 6' tall. **Water-Jel** fire blankets are 100% worsted wool and thoroughly saturated in a cooling gel. They protect against heat and flame, put out the fire, stop burn progression, and cool the skin.

| P/N | DESCRIPTION | EACH |
|---------|--------------------------------------|------|
| FA3630* | Burn Wrap, 2 1/2' x 3', Canister | |
| FA3631* | Burn Wrap, 2 1/2' x 3', Pouch | |
| FA7260 | Fire Blanket Plus, 5' x 6', Canister | |

*WHILE QUANTITIES LAST!



FA3630



FA7260



FA3631

BURN GEL

| P/N | DESCRIPTION |
|----------|------------------------------|
| FA6500 | Burn Jel, Pkg/25 |
| FA4240B | Burn Jel (Minor Burns), 4 oz |
| FA181200 | Burn Jel, Pkg/6 |
| FA160940 | Cool Jel, Pkg/25 |
| FA4240C | Cool Jel (Minor Burns), 4 oz |



FA4240B, FA4240C



Cools The Burn, Eases The Pain



FA081820

Medical-grade **Water-Jel®** **STERILE BURN DRESSINGS** ease pain, cool the burn, and help protect against airborne contamination.

| P/N | DESCRIPTION |
|----------|-------------------------|
| FA020660 | Burn Dressing, 2" x 6" |
| FA6502 | Burn Dressing, 4" x 4" |
| FA041628 | Burn Dressing, 4" x 16" |
| FA081820 | Burn Dressing, 8" x 18" |



FA1WK5

Cover most burn situations with **Water-Jel®** **BURN KITS**.

Featuring sterile **Water-Jel** burn dressings in the most popular sizes, each kit contains a host of water-based/water-soluble gel dressings that won't stick to wounds or trap heat.

| P/N | DESCRIPTION |
|--------|---|
| FA1600 | Emergency Soft-Sided Burn Kit, Small |
| FA2300 | Emergency Soft-Sided Burn Kit, Large |
| FA1WK5 | Emergency Industry Welding Burn Kit (Plastic) |

| KIT CONTENTS | FA1WK5 | FA1600 | FA2300 |
|--------------------------------------|--------|--------|--------|
| Burn Dressing, 2" x 6" | 1 | - | - |
| Burn Dressing, 4" x 4" | 2 | 2 | 3 |
| Burn Dressing, 4" x 16" | 1 | 2 | 1 |
| Burn Dressing, 8" x 18" | 1 | - | 1 |
| Burn Dressing, 12" x 16" (Face Mask) | 1 | 1 | 1 |
| Sterile Gauze (Roll), 3" x 4 yds | - | 2 | 4 |
| Scissors | - | 1 | 1 |
| Water-Jel Blanket, 2 1/2' x 3' | - | - | 1 |
| Single Dose Burn Jel | 25 | - | - |
| Elastic Bandage | 1 | - | - |
| Instruction Card | 1 | 1 | 1 |



HSAEDBAS



HSAEDBAS IN CASE

DEFIBRILLATORS

HeartSine's Samaritan® Pad AED was designed especially for use in public areas, providing a sophisticated defibrillator for adult or pediatric use inside a lightweight and easy-to-operate system.

Battery and electrode pads are incorporated into an "all-in-one" **Pad-Pak™**, sharing a single expiry date. Designed for the minimally trained rescuer, the semi-automatic **Samaritan PAD** has both visual prompts along with voice/icon prompts for easy instruction.

Includes **Samaritan Defibrillator**, adult pad-pak, storage/carrying case, data port, quick instruction card, user manual, and CPR poster. Medical Authorization Form included with sale of each unit.

NOTE: Good Samaritan laws provide limited immunity for AED owners.

PRIMARY UNITS

| P/N | DESCRIPTION | EACH |
|----------|-------------------------------------|------|
| HSAEDBAS | Samaritan PAD 300P, 1 Adult Pad-Pak | |

SERVICES & TRAINING TOOLS

| P/N | DESCRIPTION | EACH |
|------------|--|------|
| HSAEDTRN05 | Samaritan PAD Trainer, AHA/ERC 2005 & 2000 | |
| HSAEDTRN02 | Trainer Defibrillator Pads, Pkg/10 | |

ACCESSORIES

| P/N | DESCRIPTION | EACH |
|---------------|---|------|
| DDPHSAEDPAK01 | Pad-Pak Adult Cartridge | |
| DDPHSAEDPAK02 | Pad-Pak Pediatric Cartridge | |
| DDPHSAEDACC01 | Saver EVO Software (CD ROM) & USB Cable | |
| DDPHSAEDACC02 | Samaritan PAD USB Cable Only | |



DDPHSAEDPAK01



Simple To Operate With Real CPR Help®!

Zoll's® **AED PLUS® PACKAGE** is easily operated by almost anyone, thanks to its **Real CPR Help®** software with audio and text prompts. There's also a visual bar gauge on the screen to show each depression as it's taking place. The **AED Plus Package** lasts for five years, once it's installed, so there's no maintenance or testing needed. Ingress protection rating is IP55 for dust and water, meaning it's okay to place it in almost any environment. The system is powered by ten lithium batteries (included).

| P/N | DESCRIPTION | EACH |
|------------|---|------|
| ZAEDPLUSP1 | AED Plus Package | |
| ZCABMW | Standard Metal Wall Cabinet | |
| ZDPAD | CPR-D Padz - Adult Electrodes | |
| ZDL123A | Duracell Ultra CR123A Lithium Batteries, Pkg/10 | |



ZAEDPLUSP1

AED PROTECTIVE CABINETS

JL Industries LIFE START™ SERIES AED CABINETS

fit most AED units. Both surface mounted and recessed cabinets are available. Sizes listed on page 31.

| P/N | DESCRIPTION | EACH |
|----------|-------------------------------------|------|
| 1413F12 | Surface-Mount Wall Cabinet w/ Alarm | |
| 1417F12 | Semi-Recessed Wall Cabinet w/ Alarm | |
| FA140235 | Wall Bracket for AED Unit | |



1413F12

Wall-mountable **AED PROTECTIVE CABINETS**, from **STI**, keep AED units free of dust and dirt, plus they discourage vandalism via a thumb lock. Select from three different styles: No Alarm, Stop Sign Alarm (105 dB of 95 dB warning horn), or Siren/Strobe Alarm (alarm and bright flashing LED combo). Set the alarm timing for 15 seconds, 30 seconds, 60 seconds, or continuous. Measure 12 1/4" L x 14 1/4" H x 6 1/2" D.

| P/N | DESCRIPTION | EACH |
|---------------|--|------|
| STI7531AED | AED Protective Cabinet, Polycarbonate w/ Backplate, Wire Shelf, & Clear Thumb Lock | |
| DDPSTI7533AED | AED Protective Cabinet, Polycarbonate w/ Backplate, Wire Shelf, Stop Sign Alarm, & Clear Thumb Lock | |
| DDPSTI7535AED | AED Protective Cabinet, Polycarbonate w/ Backplate, Wire Shelf, Siren/Strobe Alarm, & Clear Thumb Lock | |



STI7531AED



DDPSTI7533AED



DDPSTI7535AED





FA11403000010

DEFIBRILLATOR REPLACEMENT PARTS

CARDIAC SCIENCE

| P/N | DESCRIPTION | EACH |
|-----------|--|------|
| FA9146101 | Powerheart AED G3 Battery for 9300A, 9300E | |
| FA9143101 | FirstSave AED G3 Battery for 9300C | |
| FA9131001 | Adult Defibrillation Pads | |
| FA9730002 | Pediatric Defibrillation Pads | |

DEFIBTECH

| P/N | DESCRIPTION | EACH |
|-----------|------------------------------------|------|
| FADCF210 | High-Capacity Lithium Battery Pack | |
| FADDP100 | Adult Defib/Monitoring Pads | |
| FADDP200P | Child Defib/Monitoring Pads | |

MEDTRONIC - LIFEPAK® PLUS, LIFEPAK EXPRESS

| P/N | DESCRIPTION | EACH |
|---------------|---|------|
| FA11403000010 | "Automated External Defibrillator" Stand-Out Sign (5"L x 6"H) | |
| FA11403000002 | Replacement Kit for Charge-Pak Battery Charger (1 Battery, 1 Electrode Sets) | |



FADDP100

MEDTRONIC - LIFEPAK® 500

| P/N | DESCRIPTION | EACH |
|----------------|--|------|
| FA119960000170 | Quik-Combo Pacing/Defibrillation/ECG Electrodes w/ Redi-Pak Preconnect System | |
| FA11141000147 | LifePak 500 Nonrechargeable Lithium Sulfur Dioxide Battery Pack, Yellow | |
| FA11141000002 | LifePak 500 Rechargeable SLA Battery Pack | |

PHILIPS - HEARTSTART ONSITE M5066A

| P/N | DESCRIPTION | EACH |
|----------|---|------|
| FAM5071A | Adult Smart Pads Cartridge (1 Set) | |
| FAM5072A | Infant/Child Smart Pads Cartridge (1 Set) | |
| FAM5070A | HeartStart 4-Year Battery | |



PTD261

PHILIPS - HEARTSTART FRX 861304

| P/N | DESCRIPTION | EACH |
|----------------|---------------------------|------|
| FA989803139261 | Smart Pads II | |
| FAM5070A | HeartStart 4-Year Battery | |

WELCH ALLYN - AED10™ 970302E

| P/N | DESCRIPTION | EACH |
|-------------|--------------------------------|------|
| DDPFA001853 | Multipurpose Defib Pad (Box/1) | |

OTHER ACCESSORIES

| P/N | DESCRIPTION | |
|----------|--|--------------|
| PTD261 | "Automated External Defibrillator" Stand-Out Sign (5"L x 6"H) | SEE PAGE 154 |
| G261 | Glow-in-the-Dark AED Label (6"L x 8"H) | SEE PAGE 154 |
| AEDTAGBK | AED Service Tag, Pkg/100 | SEE PAGE 165 |
| NIPFT102 | Nitrile Gloves, Pkg/100, Small | |
| NIPFT103 | Nitrile Gloves, Pkg/100, Medium | |
| NIPFT104 | Nitrile Gloves, Pkg/100, Large | |
| NIPFT105 | Nitrile Gloves, Pkg/100, X-Large | |



NIPFT104





*Legislative Support:
Your industry watchdog.*

REPLACEMENT SPRINKLER HEADS

Globe® GL SERIES SPRINKLERS feature a low-profile yet durable design, utilizing a frangible 5mm glass ampule as the thermo-sensitive element. This actuating assembly is hermetically sealed, containing a precise amount of fluid. When heat is absorbed, fluid expands, shattering the glass at the prescribed temperature and discharging the water in an approved pattern (depending upon deflector style.) **Globe Sprinklers** are aesthetically pleasing, making them a great choice in any building, wherever standard spray sprinklers are specified. They're also available in different styles, orifices, temperature ratings, and finishes to meet varying design requirements. UL listed and FM approved.

GL Series Heads (1/2" w/ 5.6 "K" Factor)

| P/N | DESCRIPTION | EACH |
|----------|------------------------|------|
| SP135 | 135°F Pendent, Brass | |
| SU135 | 135°F Upright, Brass | |
| SPC135 | 135°F Pendent, Chrome | |
| SP155 | 155°F Pendent, Brass | |
| SU155 | 155°F Upright, Brass | |
| SPSW155 | 155°F Sidewall, Brass | |
| SPC155 | 155°F Pendent, Chrome | |
| SPSW155C | 155°F Sidewall, Chrome | |
| SPW155 | 155°F Pendent, White | |
| SPSW155W | 155°F Sidewall, White | |
| SP200 | 200°F Pendent, Brass | |
| SU200 | 200°F Upright, Brass | |
| SPSW200 | 200°F Sidewall, Brass | |
| SPC200 | 200°F Pendent, Chrome | |
| SPSW200C | 200°F Sidewall, Chrome | |
| SPW200 | 200°F Pendent, White | |
| SPSW200W | 200°F Sidewall, White | |
| SP286 | 286°F Pendent, Brass | |
| SU286 | 286°F Upright, Brass | |
| SPSW286 | 286°F Sidewall, Brass | |
| SPSW286C | 286°F Sidewall, Chrome | |
| SPW286 | 286°F Pendent, White | |

GL Series Heads (3/4" w/ 8.1 "K" Factor)

| P/N | DESCRIPTION | EACH |
|---------|----------------------|------|
| 34SP155 | 155°F Pendent, Brass | |
| 34SU155 | 155°F Upright, Brass | |
| 34SP200 | 200°F Pendent, Brass | |
| 34SU200 | 200°F Upright, Brass | |

SPRINKLER SPECIALTIES

For an extra measure of protection, use **SPRINKLER CAGES** in areas where sprinklers are exposed and susceptible to damage. These tough metal cages are available in either one- or two-piece construction and in your choice of red or chrome. Fits most 1/2" or 3/4" sprinkler heads.

| P/N | DESCRIPTION | EACH |
|--------|-------------------------------------|------|
| SPC660 | 1-Piece, Red, 1/2" | |
| SPC670 | 1-Piece, Chrome, 1/2" | |
| SPC675 | 2-Piece, Red, 1/2" | |
| SPC685 | 2-Piece, Chrome, 1/2" | |
| SPC680 | 2-Piece, Red, 3/4" | |
| SPC690 | 1-Piece w/ Shield, Red, 1/2" & 3/4" | |
| SPC692 | 1-Piece "Mini", Chrome, 1/2" & 3/4" | |



SP135



SU135



SPC135



SPW155



SPSW155, SPSW155C, SPSW155W



SPC660



SPC675



SPC690



SPC692



We offer two sizes of **SPRINKLER HEAD CABINETS** to help you meet code requirements—6 and 12 head. Each cabinet is constructed from steel with red enamel finish and accommodates 1/2" and 3/4" heads as well as most sprinkler wrenches. Pre-drilled for easy wall mounting. Contents not included.

| P/N | DESCRIPTION | L X H X W | EACH |
|-------|-----------------|-----------------------|------|
| SHC6 | 6-Head Cabinet | 14" x 5" x 2 1/2" | |
| SHC12 | 12-Head Cabinet | 14 1/4" x 5 1/2" x 4" | |

The strong, lightweight **FireTech™ NIPPLE TOTE BOX** holds 3/8" and 1/2" nipples (close thru 6") and features a fold-away handle for easy storage. Box is constructed of 18-gauge steel with red enamel finish for long-lasting durability. Box has 77 compartments. Contents not included.

| P/N | DESCRIPTION | L X H X W | EACH |
|------|-----------------|---------------------------|------|
| PNT1 | Nipple Tote Box | 10 5/8" x 6 1/2" x 7 3/8" | |

The **FireTech™ FITTINGS TOTE TRAY** is another great idea for organizing and carrying a wide variety of fittings. Manufactured of 18-gauge steel with red enamel finish for superior durability, each tray has a fold-away handle for easy storage. Box has seven compartments. Contents not included.

| P/N | DESCRIPTION | L X H X W | EACH |
|------|--------------------|----------------|------|
| PFT2 | Fittings Tote Tray | 15" x 5" x 10" | |

For Fittings and Nipples, See Section 12.

Smarten up the appearance of sprinklers with **WALL ESCUTCHEONS** from **Brooks**. Available in solid or split designs, the heavy-duty split version uses springs to perfectly center the escutcheon on pipe and sprinkler heads. The split version is also ideal for installation around existing heads. Chrome plated.

| P/N | DESCRIPTION | EACH |
|-------|---------------------------------------|------|
| EP700 | Solid Escutcheon, 1/2" ID x 2 3/8" OD | |
| EP200 | Split Escutcheon, 1/2" ID x 2 5/8" OD | |
| EP300 | Split Escutcheon, 3/4" ID x 2 3/4" OD | |

These canopy-style two-piece **ESCUTCHEONS** are available with solid or split cups. The split version is perfect for installation around existing sprinkler heads, while the solid is used prior to head installation. Order one cup and one skirt for each sprinkler head. Chrome plated with 1/2" ID x 3 3/8" OD.

| P/N | DESCRIPTION | EACH |
|-------|------------------------------------|------|
| EP600 | Solid Escutcheon Cup | |
| EP650 | Split Escutcheon Cup | |
| EP500 | Escutcheon Skirt for EP600 & EP650 | |

Globe® TWO-PIECE RECESSED ESCUTCHEONS are available in white or chrome and fit **Globe 1/2" GL** model sprinkler heads flawlessly. UL listed and FM approved.

| P/N | DESCRIPTION | EACH |
|------|--|------|
| EP10 | Chrome Escutcheon, 1/2" ID x 2 3/4" OD | |
| EP20 | White Escutcheon, 1/2" ID x 2 3/4" OD | |



SHC12



PNT1



PFT2



EP700



EP200



EP600, EP500



EP650



EP10



6 SPRINKLER ACCESSORIES & STANDPIPE EQUIPMENT



PRO250



PRO1

If you're working with pipe or sprinklers, they'll work better with **ProSeal**. This **PTFE PIPE THREAD SEALANT** lubricates, protects, and seals threads and fittings. Works on stainless steel, nickel, synthetic rubbers, brass, galvanized iron, and more.

| P/N | DESCRIPTION | EACH |
|--------|--------------------------|------|
| PRO250 | ProSeal w/ Brush, 250mil | |
| PRO1 | ProSeal, 1lit | |

This **PIPE DOPE BRUSH**, with 6" wood handle and natural fibers, is a longtime favorite with pipe fitters.

| P/N | DESCRIPTION | EACH |
|-----|-----------------|------|
| PDB | Pipe Dope Brush | |



PDB

Quickfit SPRINKLER SHUT-OFF. Simple, quick positive shutoff for many types of sprinkler heads with openings of approximately 1" x 7/8" or 1 11/16" x 3/4". Allows sprinkler heads out of fire area to be shut off.

| P/N | DESCRIPTION | EACH |
|------|--------------------|------|
| SP50 | Sprinkler Shut-Off | |



SP50

SPRINKLER WRENCHES for **Globe®** sprinklers.

| P/N | DESCRIPTION | EACH |
|--------|--|------|
| RSW2 | Recessed Sprinkler Wrench For 1/2" "GL" & "U" Style | |
| SPWR2 | Sprinkler Wrench For 1/2" "GL" Style | |
| SPWR34 | Sprinkler Wrench For 3/4" "GL" Style | |



RSW2



SPWR2



SPWR34

PTFE TAPE

| P/N | DESCRIPTION | EACH |
|--------|-------------------------------|------|
| T520 | White, 1/2" x 520" | |
| T75 | White, 3/4" x 520" | |
| T520HD | Hi-Density, Pink, 1/2" x 520" | |



T520HD, T75

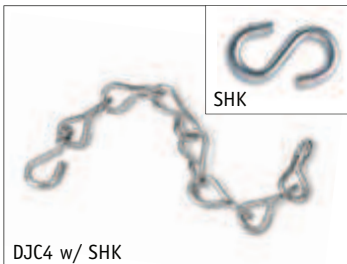

DJC4 w/ SHK

DOUBLE JACK CHAIN for hanging sprinkler signs.

| P/N | DESCRIPTION | EACH |
|------|-----------------------|------|
| DJC4 | Double Jack Chain, 4" | |
| SHK | S-Hooks, 1", Pkg/100 | |

SEE PAGE 288

Stick with **Brooks** for the best product selection in the industry, like this **DOUBLE-SIDED FOAM TAPE**. Perfect for mounting signs, with numerous other uses, this closed-cell cross-linked polyethylene foam tape utilizes a synthetic polymer-based adhesive that attaches to most smooth and irregular surfaces. Tape is easily cut to desired lengths.

NOTE: Apply at 50°F or higher.

| P/N | DESCRIPTION | EACH |
|---------|------------------------------------|------|
| FT75108 | Double-Sided Foam Tape, 3/4" x 99' | |

MAGNETIC TAPE makes mounting signs, breaker bars, and other metal goods fast and simple. Adhesive-backed tape (for temperatures 32°F to 140°F) comes in easy-to-cut rolls.

| P/N | DESCRIPTION | EACH |
|--------|----------------------------|------|
| MS5100 | Magnetic Tape, 1/2" x 100' | |



FT75108



MS5100



SPRINKLER IDENTIFICATION SIGNS

SPRINKLER IDENTIFICATION SIGNS are made of aluminum, painted white, and printed with fade-resistant red ink. Each sign has predrilled mounting holes for easy installation.

| P/N | DESCRIPTION | L X H |
|------|---------------|---------|
| A221 | "Air Control" | 6" x 2" |
| A222 | "Air Line" | 6" x 2" |
| A223 | "Alarm Line" | 6" x 2" |
| A163 | "Alarm Test" | 6" x 2" |

SPRINKLER IDENTIFICATION SIGNS are made of aluminum, painted white, and printed with fade-resistant red ink. Each sign has predrilled mounting holes for easy installation.

| P/N | DESCRIPTION | L X H |
|------|----------------------|---------|
| A224 | "Anti-Freeze System" | 6" x 2" |
| A225 | "Auxiliary Drain" | 6" x 2" |

SPRINKLER IDENTIFICATION SIGNS are made of aluminum, painted red, and printed with fade-resistant white ink. Each sign has predrilled mounting holes for easy installation.

| P/N | DESCRIPTION | L X H |
|-------|--------------------------|---------|
| A142* | "This Valve Controls..." | 6" x 4" |
| A226 | "This Valve Controls..." | 9" x 7" |

*NOT PLASTIC COATED

SPRINKLER IDENTIFICATION SIGNS are made of aluminum, painted white, and printed with fade-resistant red ink. Each sign has predrilled mounting holes for easy installation.

| P/N | DESCRIPTION | L X H |
|------|-----------------|---------|
| A143 | "Control Valve" | 6" x 2" |
| A227 | "Drain" | 6" x 2" |
| A228 | "Drain Valve" | 6" x 2" |
| A229 | "Dry Standpipe" | 6" x 2" |

SPRINKLER IDENTIFICATION SIGNS are made of aluminum, painted white and printed with fade-resistant red ink. Each sign has predrilled mounting holes for easy installation.

| P/N | DESCRIPTION | L X H |
|------|------------------------|---------|
| A160 | "Inspection Test" | 6" x 2" |
| A243 | "Fire Sprinkler Valve" | 6" x 2" |

SPRINKLER IDENTIFICATION SIGNS are made of aluminum, painted white or red, and printed with fade-resistant white or red ink. Each sign has predrilled mounting holes for easy installation.

| P/N | DESCRIPTION | L X H |
|-------|-----------------------|---------|
| A164* | "Hydraulic Data..." | 6" x 4" |
| A232 | "Hydraulic System..." | 5" x 7" |

*NOT PLASTIC COATED



A223



A163



A224



A225



A142



A226



A143



A227



A228



A229



A160



A243



A164



A232

NOTE: Signs are shipped with removable plastic film.





A233



A235



A161



A236



A162



A165

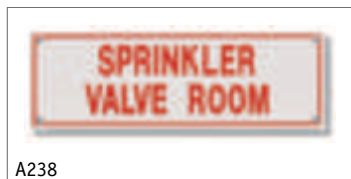

A238



A239



A242



RP251



BL252L



A245



A244



RA246

SPRINKLER IDENTIFICATION SIGNS are made of aluminum, painted white, and printed with fade-resistant red ink. Each sign has predrilled mounting holes for easy installation.

| P/N | DESCRIPTION | L X H |
|------|--------------------------|---------|
| A233 | "Main Control" | 6" x 2" |
| A161 | "Main Drain" | 6" x 2" |
| A234 | "Normally Closed" | 6" x 2" |
| A235 | "Normally Open" | 6" x 2" |
| A236 | "Open Sprinkler Control" | 6" x 2" |
| A237 | "Open Sprinkler Drain" | 6" x 2" |
| A162 | "Sprinkler Control" | 6" x 2" |

SPRINKLER IDENTIFICATION SIGNS are made of aluminum, painted white, and printed with fade-resistant red ink. Each sign has predrilled mounting holes for easy installation.

| P/N | DESCRIPTION | L X H |
|-------|---------------------------|--------------------------------------|
| A165* | "Sprinkler Fire-Alarm..." | 7 ³ / ₄ " x 6" |
| A238 | "Sprinkler Valve Room" | 6" x 2" |
| A239 | "Test & Drain" | 6" x 2" |
| A240 | "Test Valve" | 6" x 2" |
| A241 | "Water Motor Line" | 6" x 2" |
| A242 | "Wet Standpipe" | 6" x 2" |

*NOT PLASTIC COATED

NOTE: Above signs are shipped with removable plastic film.

SPRINKLER ALARM SIGNS are made of plastic, painted red and printed with fade-resistant white ink. Each sign has a predrilled mounting hole for easy installation over alarm bell.

| P/N | DESCRIPTION | DIA | EACH |
|-------|----------------------------|-----|------|
| RP251 | "Sprinkler Fire Alarm ..." | 7" | |

FIRE SPRINKLER LINE LABELS, with arrow, are printed with fade-resistant red ink on white self-adhesive vinyl. Use them to identify sprinkler lines and direction of water flow. Rolls of 50 labels.

| P/N | DESCRIPTION | EACH |
|--------|--------------------------------------|------|
| BL252L | "Fire Sprinkler Line" w/ Left Arrow | |
| BL252R | "Fire Sprinkler Line" w/ Right Arrow | |

These quality made **FDC SIGNS** help firefighters find water sources quickly. Signs are made of aluminum with predrilled holes for easy mounting.

| P/N | DESCRIPTION | EACH |
|-------|---|------|
| A244 | "Fire Department Connection", 4" x 6" | |
| A245 | "FDC" w/ Arrow, 12" x 10", 4" Letters | |
| A246 | "FDC", 10" x 14", 6" Letters | |
| RA246 | "FDC", Reflective Letters, 7" x 14", 6" Letters | |



SPRINKLER GAUGES AND VALVES

SPRINKLER GAUGES are manufactured to exact standards, with only the finest materials, for maximum performance year in and year out. Designed for wet or dry sprinkler systems. UL listed and FM approved.

Metal-Backed **GAUGES** (4")

| P/N | DESCRIPTION | EACH |
|-------|---|------|
| →MSG1 | Air Gauge, 0–80 (Water Retard to 250 psi) | |
| →MSG2 | Water Gauge, 0–300 psi | |
| →MSG3 | Air/Water Gauge, 0–300 psi | |

Plastic-Backed **GAUGES** (3½")

| P/N | DESCRIPTION | EACH |
|-----|---|------|
| SG1 | Air Gauge, 0–80 (Water Retard to 250 psi) | |
| SG2 | Water Gauge, 0–300 psi | |
| SG3 | Air/Water Gauge, 0–300 psi | |

Customize Your Gauge Order with Your Name and Phone Number! Call your Sales Rep at 800.826.3473 for more information.

Help your customers comply and show the AHJ that sprinkler gauges have been tested/replaced (within the 5 year period by NFPA 25) with the **SPINKLER GAUGE INSTALLATION LABEL**. Label includes spaces to record the installation date (which is different from the manufacturer date) and the date to test or replace the gauge.

| P/N | DESCRIPTION | EACH |
|-------|--|------|
| →SGIL | Sprinkler Gauge Installation Label, Roll/300 | |

The **SPRINKLER GAUGE VALVE KIT** is perfect for sprinkler systems without 3-way valves or ones that need replacing. **SGVK** comes with three ¼" nipples (2 ½", 4", and 6"), a ½" x ¼" reducing bushing, a brass 2-way valve, and a ¼" plug. **TWGV25** allows gauge replacement without shutting off the water.

| P/N | DESCRIPTION | EACH |
|--------|--|--------------|
| →SGVK | 3-Way Gauge Valve Kit | |
| →SGKP_ | 3-Way Gauge Valve Kit w/ Plastic Gauge | |
| →SGKM_ | 3-Way Gauge Valve Kit w/ Metal Gauge | |
| TWGV25 | ¼" 3-Way Gauge Valve | |
| →BP47 | ¼" x ½" Black Bushing | SEE PAGE 293 |
| BP48 | ¼" Black Plug | SEE PAGE 293 |
| N2525 | ¼" x 2½" Black Pipe Nipple | SEE PAGE 292 |
| N2540 | ¼" x 4" Black Pipe Nipple | SEE PAGE 292 |
| N2560 | ¼" x 6" Black Pipe Nipple | SEE PAGE 292 |

The **HEAVY-DUTY VALVE TAMPER SEALS** are both deterrents and indicators of the unauthorized opening or closing of the sprinkler system valves. They meet the installation requirements of NFPA 13 and inspection requirements of NFPA 25 for sprinkler systems too. (Attach seals to valves in a manner that the valves cannot be operated without breaking the seals.) Each seal is stamped with a 7-digit serial number that can be recorded to show who performed the installation, inspection, or maintenance. **IMPRINT SEAL** is available with 3-lines, 8 characters per line. Minimum 3,000. Matted in strips of 10 for ease-of-use. Sold in boxes of 1,000.

NOTE: When seals are used, valves should be inspected weekly.

| P/N | DESCRIPTION | EACH |
|------------|--|------|
| →HDVTS18 | Heavy-Duty Valve Tamper Seals, 18" | |
| →SSPHDVT18 | Imprint Heavy-Duty Valve Tamper Seals, 18" | |



2014 © BROOKS EQUIPMENT COMPANY, LLC



SLT



STDV1

LINE TESTER is ideal for installing the last sprinkler head on system branch lines or controlling water flow in flushing/testing situations. Comes complete with cap and chain. Cast brass.

| P/N | DESCRIPTION | EACH |
|-----|---------------------|------|
| SLT | Line Tester, 1" NPT | |

Solid brass **TEST & DRAIN VALVES**, from **Brooks**, meets all the requirements for inspecting and testing a wet-pipe sprinkler system. A chrome-plated ball and **PTFE** seats ensure easy operation and positive shut-off.

| P/N | DESCRIPTION | EACH |
|---------|---|------|
| STDV1 | 1" Test & Drain Valve, 1/2" Orifice | |
| STDV125 | 1 1/4" Test & Drain Valve, 1/2" Orifice | |



SGV100



SAV200

STRAIGHT GLOBE VALVES are made with a **PTFE** seat for improved sealing. 200 WOG. Cast brass.

| P/N | DESCRIPTION | EACH |
|--------|------------------|------|
| SGV50 | 1/2" Globe Valve | |
| SGV100 | 1" Globe Valve | |

Commonly used in a sprinkler system at the riser, this **GLOBE ANGLE VALVE** is ideal for trim and drain applications. It can also be used on both alarm valves and shotgun-type risers. The soft seat design, utilizing **NBR** material, provides positive sealing (up to 200 psi). Valve is female by female with NPT threads. Cast brass.

| P/N | DESCRIPTION | EACH |
|--------|----------------------|------|
| SAV200 | 2" Globe Angle Valve | |



411



413

HOSE VALVES

Engineered for trouble-free operation, these **ANGLE HOSE VALVES** are designed for use with hose storage devices and hydrants. Each valve has a 300 lb rating and is UL listed and FM approved. Constructed of cast brass with red or silver handwheels.

| P/N | DESCRIPTION | EACH |
|------|---|------|
| 411 | 1 1/2" NPT(F) x 1 1/2" NPT(F) Valve, Red | |
| B411 | 1 1/2" NPT(F) x 1 1/2" NPT(F) Valve, Silver, Domestic | |
| 412 | 2 1/2" NPT(F) x 2 1/2" NPT(F) Valve, Red | |
| 413 | 1 1/2" NPT(F) x 1 1/2" NST(M) Valve, Red | |
| B413 | 1 1/2" NPT(F) x 1 1/2" NST(M) Valve, Silver, Domestic | |
| 414 | 2 1/2" NPT(F) x 2 1/2" NST(M) Valve, Red | |
| B414 | 2 1/2" NPT(F) x 2 1/2" NST(M) Valve, Silver, Domestic | |
| 415 | 1 1/2" NPT(F) x 1 1/2" NPSH(M) Valve, Red | |



421



423

Some of the finest working **PRESSURE REDUCING ANGLE VALVES** you'll find in the industry. Valves can be adjusted to restrict pressures up to 175 lbs and come with locking pin devices that restrict full opening of valve by untrained personnel. Pin may be removed by fire personnel for unrestricted operation in emergencies. UL listed. Cast brass construction with red handwheels.

| P/N | DESCRIPTION | EACH |
|-----|-------------------------------------|------|
| 421 | 1 1/2" NPT(F) x 1 1/2" NPT(F) Valve | |
| 422 | 2 1/2" NPT(F) x 2 1/2" NPT(F) Valve | |
| 423 | 1 1/2" NPT(F) x 1 1/2" NST(M) Valve | |
| 424 | 2 1/2" NPT(F) x 2 1/2" NST(M) Valve | |



Heavy-duty **GATE VALVES**, from **Brooks**, are designed for use on pump test headers and dry systems as a fire hose connection. Valves feature a straightway pattern and come with caps and chains. Other features include solid wedge discs with tapered seats and a 300 lb rating. Models **433** and **434** are UL listed and FM approved. Model **B433** is UL listed only. Cast brass construction with red handwheels.

| P/N | DESCRIPTION | EACH |
|------|---|------|
| 433 | 2 1/2" NPT(F) x 2 1/2" NST(M) Valve | |
| B433 | 2 1/2" NPT(F) x 2 1/2" NST(M) Valve, Domestic | |
| 434 | 3" NPT(F) x 2 1/2" NST(M) Gate Valve, Rising Stem | |



SINGLE HYDRANT GATE VALVES are used on fire hydrant outlets for a slow and precise control of flow (throttling). Solid brass valves feature metal-to-metal seats and non-rising stems with an aluminum crank handle or red handwheel. They come standard in a straightway pattern and with a 300 lb rating.

| P/N | DESCRIPTION | EACH |
|------|---|------|
| 443 | 2 1/2" NST(F) x 2 1/2" NST(M) Valve w/ Swivel | |
| B443 | 2 1/2" NST(F) x 2 1/2" NST(M) Valve w/ Swivel, Domestic | |



VALVE REPLACEMENT PARTS. Red handwheels fit **Giacomini** valves; silver handwheels fit **Powhatan**.

| P/N | DESCRIPTION | EACH |
|--------|--|------|
| PHW15 | Handwheel for Powhatan 1 1/2" Valve | |
| PHWN15 | Handwheel Nut for Powhatan 1 1/2" Valve | |
| GHW15 | Handwheel for Giacomini 1 1/2" Valve | |
| PHW25 | Handwheel for Powhatan 2 1/2" Valve | |
| PHWN25 | Handwheel Nut for Powhatan 2 1/2" Valve | |
| GHW25 | Handwheel for Giacomini 2 1/2" Valve | |
| GHWN | Handwheel Nut for Giacomini Valve | |
| GSRS15 | Rubber Seal for 1 1/2" Giacomini Angle Valve | |
| PSRS15 | Rubber Seal for Powhatan 1 1/2" Angle Valve | |
| PSRS25 | Rubber Seal for Powhatan 2 1/2" Angle Valve | |



FIRE DEPARTMENT CONNECTIONS

This quality line of **STRAIGHT DOUBLE CLAPPER SIAMESE** is designed to help fire departments augment a building's water supply, typically at a structure's wall. Each connection comes with two 2 1/2" NST inlets and one 4" NPT outlet as well as twin female swivels. Capacity: 500 gpm. UL listed and FM approved. Cast brass.

| P/N | DESCRIPTION | EACH |
|--------|--------------------------------------|------|
| 613 | "Auto Spkr" Siamese | |
| 613PCD | "Auto Spkr" Siamese, Polished Chrome | |
| 623 | "Standpipe" Siamese | |



The **90° DOUBLE CLAPPER SIAMESE** is designed to assist fire departments in supplementing existing water supplies and features two 2 1/2" NST inlets and one 4" NPT outlet for a total capacity of 500 gpm. Siamese come standard with dual female swivels. UL listed and FM approved. Cast brass.

| P/N | DESCRIPTION | EACH |
|-----|---------------------|------|
| 614 | "Auto Spkr" Siamese | |
| 624 | "Standpipe" Siamese | |





An economical choice in wall-mountable siamese connections, this **STRAIGHT SINGLE CLAPPER SIAMESE** features a single clapper that swings back and forth, saving material and manufacturing costs. Also comes with two 2½" NST inlets, one 4" NPT outlet, and dual female swivels. Capacity: 500 gpm. UL listed and FM approved. Cast brass.

| P/N | DESCRIPTION | EACH |
|-----|---------------------|------|
| 612 | "Auto Spkr" Siamese | |

Another economical choice, but in a free-standing siamese connection, this **90° SINGLE CLAPPER SIAMESE** utilizes a single "swing" clapper. Each connection features two 2½" NST female swivels inlets and one 4" NPT female outlet. Capacity: 500 gpm. UL listed and FM approved. Cast brass.

| P/N | DESCRIPTION | EACH |
|-----|---------------------|------|
| 622 | "Auto Spkr" Siamese | |

Whether it's horizontal or vertical 4" pipe, we have a **CONCEALED SIAMESE** to fit. Available straight or angled, each of these connections come with two 2½" female NPT inlets and one 4" female NPT outlet and feature double drop clappers. Capacity: 500 gpm. UL listed. Cast brass.

| P/N | DESCRIPTION | EACH |
|-------|-------------------------|------|
| 641 | Straight Siamese | |
| 616D* | Angled Siamese | |
| | *WHILE QUANTITIES LAST! | |

Our **STRAIGHT HYDRANT** is an excellent choice where an auxiliary water supply is needed for the fire department typically on the roof of a building. Unit comes with two 2½" male NPT outlets and one 4" female NPT inlet. Capacity: 500 gpm. Cast brass.

NOTE: Use Angle Hose Valves to control water supply (see page 107).

| P/N | DESCRIPTION | EACH |
|-----|------------------|------|
| 633 | Straight Hydrant | |

Our **90° HYDRANT** is another excellent choice for providing auxiliary water supplies to the fire department, also typically on the roof of a building. Unit features two 2½" male NPT outlets and one 4" female NPT inlet. Capacity: 500 gpm. Cast brass.

NOTE: Use Gate Valves to control water supply (see page 107).

| P/N | DESCRIPTION | EACH |
|-----|-------------|------|
| 634 | Hydrant | |

Designed so fire departments can supplement water supplies in residential sprinkler systems, this **SINGLE INLET CONNECTION** comes with everything you need to make the connection—one 1½" male NST inlet, one 1½" female NPT outlet, and a cap and chain. Cast brass.

| P/N | DESCRIPTION | EACH |
|-----|--------------|------|
| 685 | Single Inlet | |

AUTO-SPRINKLER/STANDPIPE ESCUTCHEONS

Our selection of Fire Department Connection (FDC) **WALL ESCUTCHEONS** is made of durable red aluminum or plastic and measures approximately ¼" thick.

| P/N | DESCRIPTION | EACH |
|--------|---|------|
| FDC507 | "Auto Spkr", 4½" x 9⅝", Plastic | |
| FDC508 | "Auto Spkr", 4½" x 9⅝", Aluminum | |
| FDC509 | "Fire Dept. Conn.", 3⅞" x 7⅞", Aluminum | |



612



622



641



633



634



685



FDC507



FDC509



FDC508



If architectural standards specify high-quality brass FDC identification, look to **Brooks**. Our **ROUND WALL ESCUTCHEONS** identify and trim fire department connections seamlessly. Cast brass.

| P/N | DESCRIPTION | EACH |
|--------|----------------------------------|------|
| 841 | "Auto Spkr", 2 1/2" | |
| 661 | "Auto Spkr", 4" | |
| 661PCD | "Auto Spkr", 4", Polished Chrome | |



Add the final touch to any flush-mounted FDC with one of our **RECTANGULAR WALL ESCUTCHEONS**. These plates feature dual 2 1/2" openings that are 7" on center, making them ideal for most flush wall siamese. Cast brass.

| P/N | DESCRIPTION | EACH |
|--------|------------------------------|------|
| 667 | "Auto Spkr", Polished | |
| 667PCD | "Auto Spkr", Polished Chrome | |
| 668PCD | "Standpipe", Polished Chrome | |



SPRINKLER ACCESSORIES

AUTOMATIC STRAIGHT BALL DRIP VALVES keep water out of standpipe and sprinkler connections. Cast brass.

| P/N | DESCRIPTION | EACH |
|-----|----------------|------|
| 471 | 1/2" Ball Drip | |
| 472 | 3/4" Ball Drip | |



These **FULL-PORT 1/4-TURN BALL VALVES** come with a chrome-plated ball and **PTFE** seats, so they open easy and close tight. UL listed and FM approved. Cast brass. NPT.

| P/N | DESCRIPTION | EACH |
|-------|-------------------|------|
| BV75 | 3/4" Ball Valve | |
| BV100 | 1" Ball Valve | |
| BV150 | 1 1/2" Ball Valve | |



System Sensor® WFD Series WATERFLOW DETECTORS are compatible with schedule 10-40 steel pipe, sizes 2"-8", and can be mounted in a vertical or horizontal position. Each detector features a sealed retard, visual switch activation, and a computer-designed paddle for optimum performance. UL listed and FM approved.

| P/N | DESCRIPTION | EACH |
|-------|-----------------------------|------|
| WFDT | 1" T-Tap Waterflow Detector | |
| WFD20 | 2" Waterflow Detector | |
| WFD25 | 2 1/2" Waterflow Detector | |
| WFD30 | 3" Waterflow Detector | |
| WFD40 | 4" Waterflow Detector | |
| WFD50 | 5" Waterflow Detector | |
| WFD60 | 6" Waterflow Detector | |
| WFD80 | 8" Waterflow Detector | |



Brooks offers two types of **System Sensor® ALARM PRESSURE SWITCHES**—the **EPS10** series and the **EPS40** series. Both switches feature a sensitivity adjustment wheel, a reinforced diaphragm that resists pressure spikes, and two conduit entrances. The **EPS102** is designed for use in wet, dry, deluge, and pre-action automatic sprinkler systems, while the **EPS402** is designed for use in dry pipe systems or pressure tanks and water pressure supplies of automatic water control valves.

| P/N | DESCRIPTION | EACH |
|--------|---------------------------------------|------|
| EPS102 | Pressure Switch, 4-20 psi, (2) SPDT | |
| EPS402 | Pressure Switch, 10-100 psi, (2) SPDT | |



Monitors In Any Position.



System Sensor® electric **SUPERVISORY SWITCHES** are used to monitor the open position of PIB, OS&Y, and other type valves. Each feature a NEMA 3R-rated enclosure that's also tamper resistant. UL listed and FM approved.

| P/N | DESCRIPTION | |
|-------|---|--------------|
| PIBV2 | Supervisory Switch for Post Indicator/Butterfly Valve | SEE PAGE 120 |
| TS | Supervisory Switch for OS&Y/Pressure Reducing Valve | SEE PAGE 120 |
| PSP1 | Supervisory Switch for Non-Rising Stem Gate Valves/Ball Valves/Angle Valves | SEE PAGE 120 |

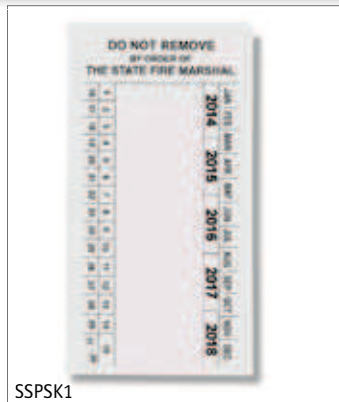

Custom-imprinted **SPRINKLER SERVICE TAGS** come with your company name or logo. Printed on one side with black ink on coated 13-pt stock. Reinforced eyelets are standard with optional metal eyelets and/or wire. Printed the 10th and 25th of each month, with delivery six to eight weeks from deadline. We must receive your final signed proof by the 10th and 25th of every month. Years are automatically changed every October. Minimum order is 4,000 tags per design or color ordered. Tags are sold and priced per 1,000. Choose your color: Yellow (Y), Red (R), Green (G), and White (W). **NOTE:** It is the customer's responsibility to be sure the tag design meets all local and state regulations. (Georgia requires Green). No imprint on back side.

| P/N | DESCRIPTION | L X H | |
|------------|---------------------------------------|-----------------|------|
| SSPSPK_ | Custom, Choose Color | 5 1/4" x 2 5/8" | |
| P/N | DESCRIPTION | | EACH |
| SSPPL | Plate Charge (New or Updated Orders) | | |
| SSPSU | Set-Up Charge (Each Order) | | |
| SSPME | Metal Eyelets Add-On | | |
| SSPWIRE | Wire Attachment Add-On | | |
| SSP2CO | Additional Red Ink Add-On | | |
| SSPTVK | Tyvek Add-On, White Only (5,000 Min.) | | |
| SSPTVKWIRE | Tyvek Wire Attachment Add-On | | |

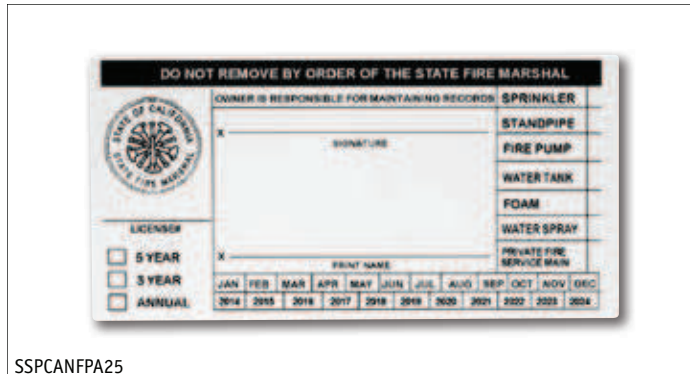

Custom-imprinted **SPRINKLER SERVICE LABELS** come with your imprint in fade-resistant black ink on white self-adhesive vinyl. If you need a different design, just order part number **SSPCSTAG** and send your design to our sales staff. Labels measure 5 1/4" x 2 5/8". Sold per 1,000.

| P/N | DESCRIPTION |
|-------------|--------------------------------------|
| SSPCANFPA25 | California NFA25 Sprinkler Label |
| SSPSK1 | Custom Sprinkler Service Vinyl Label |
| SSPCSTAG | Custom Service Label |
| SSPART | Custom Artwork |



System Sensor® **ALARM BELLS** are designed as low-current, high-decibel notification appliances for use in fire, burglary, and sprinkler systems or other signaling applications. Simple to install and approved for both indoor or outdoor use. UL listed and FM approved.

| P/N | DESCRIPTION | |
|----------|--------------------------------------|--------------|
| AB6 | 6" Alarm Bell (120VAC) | SEE PAGE 123 |
| AB624 | 6" Alarm Bell (24V) | SEE PAGE 123 |
| AB8 | 8" Alarm Bell (120VAC) | SEE PAGE 123 |
| AB824 | 8" Alarm Bell (24V) | SEE PAGE 123 |
| AB10 | 10" Alarm Bell (120VAC) | SEE PAGE 123 |
| AB1024 | 10" Alarm Bell (24V) | SEE PAGE 123 |
| BG457 | Wire Guard for 6", 8", or 10" Bells | SEE PAGE 123 |
| P2RHK120 | 120VAC Outdoor Horn/Strobe w/ Box | SEE PAGE 123 |
| ABBB | Weatherproof Backbox for Alarm Bells | SEE PAGE 123 |





*Code Compliance:
An authority on the issues.*

FIRE ALARM CONTROL PANELS – CONVENTIONAL

Fire-Lite's MS2F and MS4F FIRE ALARM CONTROL PANELS bring the latest in microprocessor technology to conventional fire controls. They are compatible with the **i3™** smoke detectors, from **System Sensor®** (see page 119), which provide such advanced features as drift compensation, maintenance alert, and freeze warning. Automatic synchronization of audio/visual devices is provided using the **System Sensor, Wheelock, or Gentex** protocol.

| P/N | DESCRIPTION |
|------|--|
| MS2F | FACP, 2-Zone, Style B, 24V, 1 Style Y NAC |
| MS4F | FACP, 4-Zone, Style B/D, 24V, 2 Style Y/Z NAC |



MS4F

Smaller facilities, like banks, grocery stores, restaurants, strip malls, etc., can benefit from **Fire-Lite's 5-ZONE and 10-ZONE PANELS**, which bring the latest technology to conventional panels. A built-in keypad, with 80-character LCD display, makes it fully programmable without the need for an external programmer. There's a built-in **Digital Alarm Communicator Transmitter (DACT)**, and they're compatible with **System Sensor® i3™** smoke detectors, providing advanced features, like drift compensation, maintenance alert, and freeze warning. The **Notification Appliance Circuit (NAC)** synchronization protocol has the ability to silence audible alarms, while the strobes continue to flash, using just a single pair of wires.

| P/N | DESCRIPTION |
|---------|-------------------------------------|
| MS5UDF | FACP 5z 2NAC CL B w/ DACT |
| MS10UDF | FACP 10z 2NAC CL B w/ DACT |
| ANN80F | 80-Character LCD Serial Annunciator |



MS5UDF, MS10UDF w/ ANN80F

FIRE ALARM CONTROL PANELS – RELEASING

For commercial, industrial, and institutional buildings that require releasing service, **Fire-Lite's 6-ZONE PANELS** (for single and dual applications) are more than up to the task. The **DDPMRP-2001F** is for deluge and pre-action applications, while the **DDPMRP-2002F** handles the agent releasing applications. Both panels are compatible with **System Sensor's i3™** detectors and transmit a maintenance trouble signal to the **FACP** when it needs cleaning. There's also a supervisory 'freeze' signal when the ambient temperature falls below the detector rating (approximately 45°F). Panels are also compatible with input devices, like two-wire or four-wire smoke detectors, pull stations, waterflow devices, and tamper switches.

| P/N | DESCRIPTION |
|-------------|-------------------------------------|
| DDPMRP2001F | 6-Zone FACP, Deluge & Pre-action |
| DDPMRP2002F | 6-Zone FACP, Agent Release |
| ANN80F | 80-Character LCD Serial Annunciator |



DDPMRP2001F



FIRE ALARM CONTROL PANELS – ADDRESSABLE

This addressable **FIRE ALARM CONTROL PANEL (FACP)**, by **Fire-Lite® Alarms**, supports up to 50 addressable devices and includes a built-in **Digital Alarm Communicator/Transmitter (DACT)** in the same circuit board, making it both compact and cost effective. The **MS9050UDF** may be connected to an 80-character fire annunciator for remote annunciation and control of system functions, including **System Acknowledge, Signal Silence, Drill, and Reset**. The **FACP** also features audio/visual device synchronization using **System Sensor®, Wheelock, and Gentex** protocol.

| P/N | DESCRIPTION |
|-----------|-------------------------------------|
| MS9050UDF | Fire Alarm Control Panel w/ DACT |
| ANN80F | 80-Character LCD Serial Annunciator |



MS9050UDF w/ ANN80F

This combination **FIRE ALARM CONTROL PANEL** and **DIGITAL ALARM COMMUNICATOR/TRANSMITTER** is a cost-effective addressable control panel with many powerful features. It operates in **LiteSpeed™** mode, giving it a quicker response time, so panels with the maximum 198 devices can report an incident fast—under 10 seconds. And there's selectable strobe synchronization for **System Sensor®, Wheelock, and Gentex** devices.

| P/N | DESCRIPTION |
|-------------|---|
| MS9200UDLSF | Intelligent Addr. FACP w/ Built-In Communicator |
| LCD80F | 80-Character LCD Remote Annunciator |
| SBB3F | Surface Mount Backbox for LCD80F |



MS9200UDLSF

The **Fire-Lite® MS9600LSF ADDRESSABLE FIRE ALARM CONTROL PANEL** supports up to 318 addressable devices on each of two signaling line circuits (second **SLC** optional) and offers **LiteSpeed™**, a patented technology that polls 10 devices at once, allowing a fully loaded panel to report an incident and activate the notification circuits in under 10 seconds, using standard twisted unshielded wire. The panel supports the low-cost **ANN-BUS**, legacy **ACS** annunciation devices for retrofit applications and a host of other features, including built-in **NAC** synchronization. Easily installed, programmed, and maintained, the **MS9600LSF** is ideal for use in schools, assisted living facilities, office buildings, malls, etc.

| P/N | DESCRIPTION |
|-------------|---|
| MS9600LSF | Addr. FACP, 1-2 SLC up to 318 pts/SLC, 24V |
| DDPSLC2LSF | SLC Expander Increases Capacity from 318 to 636 pts |
| DDPDACTUD2F | Optional DACT for Remote Monitoring |
| ANN80F | 80-Character LCD Serial Annunciator |



MS9600LSF



ADDRESSABLE DETECTORS AND ACCESSORIES

Fire-Lite's 300 SERIES ADDRESSABLE, LOW-PROFILE, PLUG-IN SMOKE DETECTORS use a state-of-the-art sensing chamber with communications to provide open area protection. They are used exclusively with **Fire-Lite's Addressable Fire Alarm Control Panels**. Since these detectors are addressable, they will help emergency personnel quickly locate a fire during its early stages, potentially saving precious rescue time and reducing property damage. Two LEDs on each sensor will light to provide a local visible sensor indication. Remote LED annunciator capability is available as an optional accessory (**RA100Z**).

| P/N | DESCRIPTION |
|------------|--|
| SD355F | Addr. Low-Profile Photo-Smoke Detector |
| H355F | Addr. Heat Detector |
| DDPSD355TF | Addr. Low-Profile Photo-Smoke Detector w/ Heat |
| DDPH355RF | Addr. 135°F Heat Detector w/ Rate-of-Rise |

→ **More Fire-Lite® ADDRESSABLE DETECTORS Available - Call for Pricing**



SD355F

The **Fire-Lite® D355PLF ADDRESSABLE DUCT SMOKE DETECTOR** features a pivoting housing that fits both square and rectangular footprints and mounts to round or rectangular ductwork. This unit senses smoke in the most challenging conditions, operating in airflow speeds of 100 to 4,000 feet per minute, temperatures of -4°F to 158°F, and a humidity range of 0% to 95% (non-condensing). A plug-in sensor head offers improved false alarm immunity and simple installation, testing, and maintenance. An improved cover design isolates the sensor head from the low-flow feature for simple maintenance.

| P/N | DESCRIPTION |
|-----------|--|
| D355PLF | Addr. Photo-Duct Detector |
| DST1 | Sampling Tube 1'-2' Duct Widths |
| DST3 | Sampling Tube 2'-4' Duct Widths |
| DST5 | Sampling Tube 4'-8' Duct Widths |
| DDPDST10 | Sampling Tube 8'-12' Duct Widths |
| RA100Z | Remote LED Mounts to Single-Gang Box |
| RTS151 | Remote Test Station, Alarm & Power LEDs |
| RTS151KEY | Remote Test Station, Alarm & Power LEDs w/ Key Reset |
| APA151 | Remote Annunciator w/ Piezo Alarm |



D355PLF



RA100Z



RTS151



ADDRESSABLE MODULES AND ACCESSORIES

Fire-Lite's 300 Series ADDRESSABLE MONITOR and CONTROL MODULES provide an interface to conventional **Initiating Device Circuits (IDC)** and **Notification Appliance Circuits (NAC)**. Modules are addressed with easy-to-use rotary code switches and are used exclusively with **Fire-Lite's Addressable Fire Alarm Control Panels**. And since these modules are addressable, they provide the flexibility to meet the requirements of most installations.

| P/N | DESCRIPTION |
|---------|--|
| MMF300F | Addr. Monitor Module, Style B/D for N.O. Contacts, w/ LED |
| MMF301F | Addr. Mini-Monitor Module Style B for N.O. Contacts, w/o LED |
| CMF300F | Addr. Control Module, Supervised, Style Z/Y NAC |
| CRF300F | Addr. Relay Module, 2 Form-C Relays |

→ **More Fire-Lite® ADDRESSABLE MODULES Available - Call for Pricing**



MMF300F SHOWN W/ COVER



MMF301F

Fire-Lite's state-of-the-art dual-action PULL STATION includes an addressable interface (mounted inside) for **Fire-Lite's Addressable Fire Alarm Control Panels**. Because the **BG12LXF** is addressable, the control panel can display the exact location of the activated manual pull station, allowing fire service personnel to locate the alarm quickly. The dual-action design requires two motions to activate the station, reducing the risk of an accidental alarm.

| P/N | DESCRIPTION |
|---------|---|
| BG12LXF | Addr. Pull Station, Dual-Action, Lexan, w/ Key Lock |



BG12LXF

Low Cost, Reliable, & Easy To Install



DDPOSI45

OPEN-AREA SMOKE IMAGING DETECTION (OSID), by **Xtralis®**, is a new innovation in projected beam smoke detection technology. By using advanced dual wavelength projected beams and optical imaging technology, **OSID** provides a low-cost, reliable, and easy-to-install solution that overcomes typical beam detection issues, such as false alarms and alignment problems.

| P/N | DESCRIPTION | EACH |
|-------------|---|------|
| DDPOSI10 | OSID Imager, 7°, 24V | |
| DDPOSI45 | OSID Imager, 38°, 24V | |
| DDPOSI90 | OSID Imager, 80°, 24V | |
| DDPOSESP | OSID Emitter, Standard Power (Battery) | |
| DDPOSESPW | OSID Emitter, Standard Power (Wired at 24V) | |
| DDPOSEHPW | OSID Emitter, High Power (Wired at 24V) | |
| DDPOSIDINST | OSID Installation Kit | |
| XLB | OSID Replacement Battery | |





VLF500

The **Xtralis® VESDA® LaserFocus® DETECTOR** is a very early warning smoke detector, designed to protect small business-critical environments of less than 500 m² (5,000 sq. ft.). The detector works by continually drawing air through sampling holes in a pipe network. The air is filtered and passed into a detection chamber where extremely small amounts of smoke are detected, while rejecting dust and other sources of false alarms.

| P/N | DESCRIPTION | EACH |
|--------|----------------|------|
| VLF500 | LaserFocus 500 | |



VPS100US120

Xtralis® POWER SUPPLIES. The **VPS100US120** is capable of providing 24V with battery backup for the **VLF500 LaserFocus®** smoke detector. Batteries not included.

| P/N | DESCRIPTION | EACH |
|-------------|--------------------------|------|
| VPS100US120 | Single-Zone Power Supply | |
| VPS300US120 | Multi-Zone Power Supply | |



PRB1212

Power Rite™ ALARM BATTERIES are tough, long lasting, and powerful.

| P/N | DESCRIPTION | EACH | CASE |
|---------|--|------|------|
| PRB1212 | 12V, 12AH, 5 ¹⁵ / ₁₆ " x 3 ¹¹ / ₁₆ " x 3 ⁷ / ₈ ", Case/4 | | |



VSP005



VSP715

VESDA® REPLACEMENT FILTER and ASPIRATOR.

| P/N | DESCRIPTION | EACH |
|--------|-----------------------------|------|
| VSP005 | Dual-Stage Filter Cartridge | |
| VSP715 | Replacement Aspirator | |



VIC020

The **Xtralis® VESDA® VIC020 MCC (MULTI-FUNCTION CONTROL CARD)** is an interface card for the range of **Xtralis VESDA VLF** smoke detectors. Installing a **VLF MCC** into a **VLF** detector provides a cost-effective solution for customers who need enhanced connectivity, fault detection, monitoring, and annunciation of alarms and faults. The principal benefits include improved **FACP** connectivity. The **VLF** is fitted with two alarm relays in its standard form. With an extra two relays, the **Multi-Function Control Card** allows reporting of all four alarm levels on dry relay outputs.

| P/N | DESCRIPTION | EACH |
|--------|----------------------|------|
| VIC020 | Relay Expansion Card | |



PIPE AND ACCESSORIES

Blazemaster™ CPVC PIPE for use with smoke sampling detector systems. Pipe is listed to UL 1887, "Fire Test of Plastic Sprinkler Pipe for Flame and Smoke Characteristics". Imprinted with "Smoke Detector Sampling Tube - DO NOT DISTURB".

| P/N | DESCRIPTION | EACH |
|-----------|--|------|
| BMPIPE120 | CPVC Pipe, 3/4" x 7 1/2', Box/16 | |
| BMPIPE240 | CPVC Pipe, 3/4" x 15', Box/16 | |
| BMELB90 | CPVC 90° 3/4" Elbow | |
| BMCOUP | CPVC 3/4" Coupling | |
| BMTEE | CPVC 3/4" Slip Tee | |
| BMUNION | CPVC 3/4" Union | |
| BMEC | CPVC 3/4" End Cap | |
| BMFAMTI | 3/4" F Adapter w/ Metal Thread Insert | |
| BMFABST | 3/4" F Adapter w/ Brass Starter Thread | |
| BMMAMTI | 3/4" M Adapter w/ Metal Thread Insert | |



BMPIPE120



BMELB90

Wiss® RATCHET PIPE CUTTERS cut up to 1 1/8" pipe.

| P/N | DESCRIPTION | EACH |
|-------|----------------------|------|
| RPCLG | Ratchet Pipe Cutters | |



RPCLG



BMCEMENT

Blazemaster™ SOLVENT CEMENT

| P/N | DESCRIPTION | EACH |
|----------|---------------------|------|
| BMCEMENT | CPVC Cement, 1 Pint | |

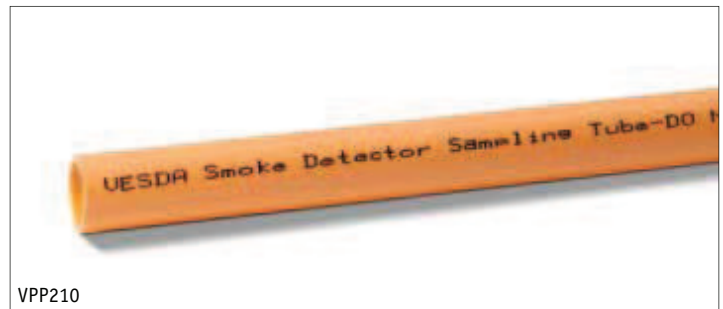

VPP210

Both the 15' and 7 1/2' lengths of 3/4" **VESDA® PIPE** are imprinted with "Smoke Detector Sampling Tube - DO NOT DISTURB" along their lengths (on opposite sides) at 18" intervals.

| P/N | DESCRIPTION | EACH |
|----------|-------------------------------|------|
| VPP210* | CPVC Pipe, 3/4" x 15', Box/14 | |
| VPELB90 | CPVC 90° 3/4" Elbows, Box/20 | |
| VPELB901 | CPVC Elbows | |
| VPCOUP | CPVC 3/4" Couplings, Box/15 | |
| VPCOUP1 | CPVC Couplings | |
| VPUNION | CPVC 3/4" Unions, Box/10 | |
| VPUNION1 | CPVC Unions | |
| VPEC | CPVC 3/4" End Caps, Box/25 | |
| VPEC1 | CPVC End Caps | |
| VPTEE | CPVC 3/4" Slip Tees, Box/15 | |
| VPTEE1 | CPVC Slip Tees | |

*MOTOR FREIGHT ONLY!



VPUNION



VPEC

VESDA® FPT CAPILLARY TEES

| P/N | DESCRIPTION | EACH |
|-----------|-------------------------------|------|
| VPTEEFPT | CPVC 1/2" Tees, Box/10 | |
| VPTEEFPT1 | CPVC 1/2" Tees, FPT Capillary | |



VPTEE



VPTEEFPT

VESDA® PIPE CUTTERS cut up to 1 1/2" pipe.

| P/N | DESCRIPTION | EACH |
|-----------|--------------|------|
| VPCUTTERS | CPVC Cutters | |



VPCUTTERS



VPCEMENT

VESDA® SOLVENT CEMENT

| P/N | DESCRIPTION | EACH |
|----------|---------------------|------|
| VPCEMENT | CPVC Cement, 1 Pint | |





E700TUBE

Black **POLYETHYLENE TUBING** comes in 1/2" OD x 3/8" ID and is flame retardant.

| P/N | DESCRIPTION | EACH |
|-----------|-----------------------------------|------|
| TUBING250 | 1/2" Black Poly Tubing, 250' Roll | |
| E700TUBE | 1/2" Black Poly Tubing, 50' Roll | |
| E700SP | Mini Capillary Sampling Point | |
| PIP015 | Flush Mount Sampling Point | |



E700SP

Brooks has a convenient, pre-assembled **CONNECTOR KIT** for miniature sampling point and capillary tube arrangement. It includes one male connector (1/2" thread x 1/2" OD compression) and one female connector (1/2" OD compression).



PIP015

| P/N | DESCRIPTION | EACH |
|------------|-------------------------------|------|
| E700CAPKIT | Capillary Quick Connector Kit | |



E700CAPKIT

VESDA® MINIATURE SAMPLING POINT LABELS



E700SPLG

| P/N | DESCRIPTION | EACH |
|----------|--|------|
| E700SPLG | Capillary Point Decals, Gray, Sheet/12 | |



E700SPDCL

VESDA® SAMPLING POINT DECALS

| P/N | DESCRIPTION | EACH |
|-----------|--|------|
| E700SPDCL | Wraparound Sample Point Decals, Roll/200 | |



SMOKE DETECTORS AND ACCESSORIES

System Sensor's i3™ Series PHOTOELECTRIC SMOKE DETECTORS are founded on three principles: installation ease, intelligence, and instant inspection. Installation ease is redefined by the simple **Stop-Drop 'N Lock** plug-in base. Intelligent features, such as **Drift Compensation** and **Maintenance Alert**, simplify testing and maintenance. Instant inspection of the detector's condition is accomplished by wide-angle red and green LED indicators.

| P/N | DESCRIPTION |
|---------|--------------------------------------|
| 2WB | Smoke, 2-Wire, 12/24V |
| 2WTB | Smoke w/ Heat, 2-Wire, 12/24V |
| 4WB | Smoke, 4-Wire, 12/24V |
| 4WTB | Smoke w/ Heat, 4-Wire |
| SENSRDR | i3 Smoke Detector Sensitivity Reader |

→ **More SYSTEM SENSOR PRODUCTS Available - Call for Pricing.**

This **12/24V CARBON MONOXIDE DETECTOR**, from **System Sensor®**, provides early warning when its electrochemical sensing technology measures carbon monoxide levels in the air. Plus with **RealTest™** technology, the CO gas sensing cell can be tested using a carbon monoxide gas agent. It will alert occupants by sounding and flashing a temp-four, 85 dB signal alarm. The **CO1224T** is specifically designed for system operation and is fully listed to UL 2075, offering a code-required trouble relay.

| P/N | DESCRIPTION |
|---------|-------------------|
| C01224T | System CO, 12/24V |

DUCT SMOKE DETECTORS AND ACCESSORIES

The **System Sensor® InnovairFlex™ 4-WIRE PHOTOELECTRIC DUCT SMOKE DETECTOR** features a pivoting housing that fits both square and rectangular footprints and mounts to round or rectangular ductwork. This unit senses smoke in the most challenging conditions, operating in airflow speeds of 100 to 4,000 feet per minute, temperatures of -4°F to 158°F, and a humidity range of 0% to 95% (non-condensing). A plug-in sensor head offers improved false alarm immunity and simple installation, testing, and maintenance. An improved cover design isolates the sensor head from the low-flow feature for simple maintenance.

| P/N | DESCRIPTION |
|-----------|---|
| D4120 | Duct Smoke, Photo, 4-Wire, 24V/120VAC or 24V |
| DST1 | Sampling Tube 1'-2' Duct Widths |
| DST3 | Sampling Tube 2'-4' Duct Widths |
| DST5 | Sampling Tube 4'-8' Duct Widths |
| DDPDST10 | Sampling Tube 8'-12' Duct Widths |
| RA100Z | Remote LED Mounts to Single-Gang Box |
| RTS151 | Remote Test Station, Alarm & Power LEDs |
| RTS151KEY | Remote Test Station, Alarm & Power LEDs w/ Key Reset |
| APA151 | Remote Annunciator w/ Piezo Alarm |



2WB



C01224T



D4120

RTS151KEY

D4120 SHOWN IN SQUARE CONFIGURATION





HEAT DETECTORS

The **5600 SERIES HEAT DETECTORS** offer a low-cost means for protection against fire where smoke detectors are inappropriate. Detectors easily mount to single-gang and octagonal backboxes. Detectors feature clear markings for identifying activation method and temperature rating in both Fahrenheit and Celsius.

| P/N | DESCRIPTION |
|--------|--|
| HD5601 | Single Circuit, Fixed/R-O-R Activation 135°F Rating |
| HD5602 | Single Circuit, Fixed/R-O-R Activation 194°F Rating |
| HD5603 | Single Circuit, Fixed Activation 135°F Rating |
| HD5604 | Single Circuit, Fixed Activation 194°F Rating |

→ **More PRODUCTS Available - Call for Pricing.**

Thermotech HEAT DETECTORS are of the rate compensation type—normally open, self-restoring, and vertical mounting only. They are UL listed, FM approved, and California listed for 50' x 50' areas.

NOTE: Not for use in direct sunlight. EPM194 for indoor use only. Call the Sales Department for technical support.

| P/N | DESCRIPTION |
|--------|-------------------------------------|
| EPM194 | 194°F Explosion-Proof Heat Detector |
| ET135 | 135°F All-Weather Heat Detector |
| ET194 | 194°F All-Weather Heat Detector |



FIRE SPRINKLER MONITORING PRODUCTS

System Sensor® WATERFLOW DETECTORS come with sealed retard, visual switch activation, and computer-designed paddle. The **WFDT** is designed to fit any 1" to 2" T-tap with a 1" NPT branch.

| P/N | DESCRIPTION | EACH |
|-------|-----------------------------|------|
| WFDT | 1" T-Tap Waterflow Detector | |
| WFD20 | 2" Waterflow Detector | |
| WFD25 | 2½" Waterflow Detector | |
| WFD30 | 3" Waterflow Detector | |
| WFD40 | 4" Waterflow Detector | |
| WFD50 | 5" Waterflow Detector | |
| WFD60 | 6" Waterflow Detector | |
| WFD80 | 8" Waterflow Detector | |

System Sensor® field-adjustable **PRESSURE SWITCHES** feature the **EPS102**, designed for use in wet, dry, deluge, and pre-action automatic sprinkler systems. The **EPS402** is designed for use in dry pipe systems, pressure tanks, and water pressure supplies of automatic water control valves.

| P/N | DESCRIPTION | EACH |
|--------|---|------|
| EPS102 | Alarm Pressure Switch, 4–20 psi | |
| EPS402 | Supervisory Pressure Switch, 10–100 psi | |

Electric **SUPERVISORY SWITCHES**, from **System Sensor®**, help prevent tampering and incorrect setting of valve controls.

| P/N | DESCRIPTION |
|-------|--|
| PIBV2 | Supervisory Switch Post Indicator/Butterfly Valve |
| TS | Supervisory Switch OS&Y/Pressure Reducing Valve |
| PSP1 | Supervisory Switch Non-Rising Stem Gate Valves/ Ball Valves/Angle Valves |

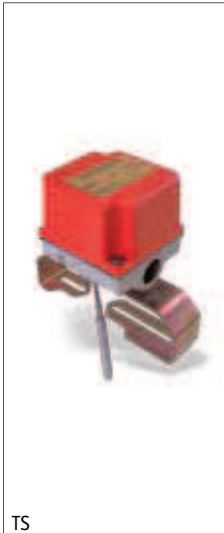

MANUAL PULL STATIONS AND ACCESSORIES

Fire-Lite's BG12 Series is a cost-effective, feature-packed non-coded series of **MANUAL FIRE ALARM PULL STATIONS** designed to meet multiple applications with the installer and end-user in mind. The **BG12 Series** features a variety of models, including single- and dual-action versions. Innovative design, durable polycarbonate construction, and multiple mounting options make the **BG12 Series** simple to install, maintain, and operate.

| P/N | DESCRIPTION |
|-------------|--|
| BG12F | Dual-Action, Terminal Block, Hex Key |
| BG12LF | Dual-Action, Terminal Block, Key Lock |
| BG12LOF | Dual-Action, Terminal Block, Key Lock, w/ Outdoor Rating |
| DDPBG12LRAF | Dual-Action Lexan, Agent Release w/ Abort Applications |
| SBI0F | Surface Mounting Indoor/Outdoor |



BG12F

Die-cast **ALARM MANUAL PULL STATION**, with **Fire-Lite's** steel back **MANUAL FIRE ALARM PULL STATIONS**, provides a single-action, normally open contact alarm initiating point for use with UL listed **Fire Alarm Control Panels (FACPs)**.

| P/N | DESCRIPTION |
|----------|---|
| BG8F | Single-Action, Aluminum, SPST |
| DDPBG2RF | Surface Box, Red, Tapped for 1/2" Conduit |



BG8F

Die-cast **ALARM MANUAL PULL STATION** features a steel back plate and 10A snap action switch. Measures 4 3/4"H x 3 1/4"W x 7/8"D. Meets UL, ULC, CSFM, and MEA requirements.

| P/N | DESCRIPTION |
|-------|--|
| MPS1 | Pull Station, SPST Pigtail |
| MPS2 | Pull Station, SPST w/ Terminal Block |
| MPS3 | Pull Station, SPST w/ Terminal Block & Key |
| MPS4 | Pull Station, DPDT |
| MPS5 | Pull Station, DPST w/ Terminal Block |
| MPSBB | Surface-Mount Backbox for Pull Station |
| GR1 | Hollow Glass Break Rod, 3" x 1/4" |



MPS2

For Additional Break Rods, See Page 122.





STI1100, MPS1

Alarm **PULL STATION PROTECTORS** are made of clear polycarbonate, with or without an 85 dB horn, and helps prevent false alarms and vandalism. Fits most pull stations.

| P/N | DESCRIPTION | H X W X D | EACH |
|---------|--|--------------------------|------|
| STI6500 | Protector w/o Horn | 5 1/2" x 4 1/8" x 2 1/4" | |
| STI6600 | Protector w/ Horn | 5 1/2" x 4 1/8" x 2 1/4" | |
| STI1100 | Protector w/ Horn | 6 3/4" x 5 1/2" x 2 3/4" | |
| STI1200 | Protector w/o Horn | 6 3/4" x 5 1/2" x 2 3/4" | |
| STI6531 | 2" Surface Conduit Spacer For STI6600 & STI6500 | | |
| STI3100 | 2" Surface Conduit Spacer For STI1100 & STI1200 | | |



BGC

ALARM BREAK GLASS COVER is made of heavy 14-gauge steel. This unique design features a slot for broken glass to fall through, minimizing possible injury during use. Outside measures 7 3/8"H x 5 1/2"W x 2 1/4"D. Key lock sold separately.

| P/N | DESCRIPTION | EACH |
|-------|---------------------------|------|
| BGC | Break Glass Cover | |
| 211KL | Key Lock Assembly for BGC | |

REPLACEMENT BREAK RODS for alarm pull stations.

| P/N | DESCRIPTION | EACH |
|-----|--|------|
| GR1 | Hollow Glass Break Rod, 3" x 1/4" | |
| GR2 | Solid Glass Break Rod, 3 1/8" x 5/32" Fits Many Popular Pull Stations | |



DH24120SC

The **DH Series FIRE DOOR HOLDERS** are made of durable die-cast metal and finished in high-luster powder-coated chrome. Their extremely low current draw saves on power supplies and backup batteries. Plus installation is easy, thanks to an adhesive template that assures proper alignment without secondary adjustments.

| P/N | DESCRIPTION |
|---------------|--|
| DH24120FC | Door Holder, 24V & 120VAC Semi-Flush Mount |
| DH24120SC | Door Holder, 24V & 120VAC Surface Mount |
| DDPDH24120RC | Door Holder, 24V & 120VAC Recessed Mount |
| DDPDH24120GC1 | Door Holder, 24V & 120VAC Ground Mount, Single Door |
| DHE4AC | Door Holder, 4" Adjustable Extension Rod |



NOTIFICATION APPLIANCES AND ACCESSORIES

For horns, strobes, and horn/strobes with hi-tech features, including easy installation, choose **System Sensor's SpectrAlert® ADVANCE SELECTABLE OUTPUT NOTIFICATION DEVICES**. The plug-in design is simple to install. Just attach the universal mounting plate to a 4" junction box. Then connect the notification appliance circuit wiring to the **SEMS** terminals on the mounting plate. Finally, attach the horn, strobe, or horn/strobe to the mounting plate. The device will rotate into position and hold until it is secured with the capture mounting screw. **SpectrAlert Advance** products work on 12 or 24 volts. The horn is rated at 88+ dB. The **P2RHK120** model is UL listed for outdoor use and can operate in extreme temperatures (-40°F to 151°F), in wet or dry conditions. All **SpectrAlert Advance** sensors are electrically compatible with existing **SpectrAlert** products.

| P/N | DESCRIPTION |
|----------|---|
| P2RHK120 | 120VAC Outdoor Horn/Strobe w/ Box |
| P2R | 12 or 24V Horn/Strobe Selectable Output |
| P2RK | 12 or 24V Outdoor Horn/Strobe w/ Box Selectable Output |
| SR | 12 or 24V Strobe Only Selectable Output |
| HR | 12 or 24V Horn |
| → | More SYSTEM SENSOR PRODUCTS Available - Call for Pricing. |

ALARM BELLS are for use in burglary, fire alarm, and sprinkler systems. Minimum 82 dB output.

| P/N | DESCRIPTION |
|--------|---|
| AB6 | 6" Alarm Bell (120VAC) |
| AB624 | 6" Alarm Bell (24V) |
| AB8 | 8" Alarm Bell (120VAC) |
| AB824 | 8" Alarm Bell (24V) |
| AB10 | 10" Alarm Bell (120VAC) |
| AB1024 | 10" Alarm Bell (24V) |
| BG457 | Wire Guard for 6", 8", or 10" Bells |
| ABBB | Weatherproof Backbox For Alarm Bells |

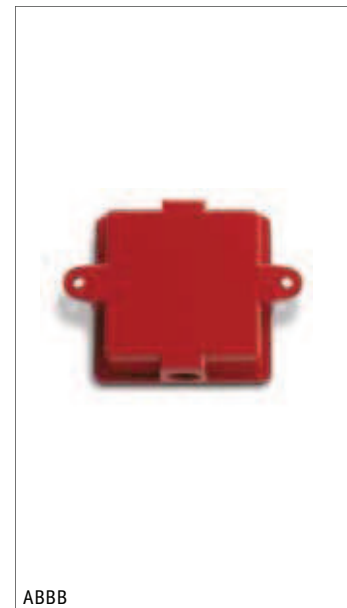

A Sound Choice.

The **DBchecker™** is a **SOUND LEVEL METER** that tests audible appliances for the public operating mode of an emergency voice/alarm system. Easy to use, it conforms to ANSI S1.4 Type 2, which is required by NFPA 72. Measuring levels range from 32 dB to 130 dB, at frequencies between 31.5 Hz to 8 kHz. Unit has two equivalent weighted sound pressure levels (A and C) and displays with a resolution of 0.1 dB on a four-digit LCD screen. 9 volt alkaline battery included.

| P/N | DESCRIPTION | EACH |
|------|-----------------------------|------|
| DB01 | DBchecker Sound Level Meter | |



Tests Smoke & Heat

The first of its kind, the **Testifire® DETECTOR TESTER** can create multiple stimuli simultaneously. Meaning now, only one tool is needed to test for smoke and heat. It's even eco-friendly, since the test capsules produce no global warming (GWP) or volatile organic compounds (VOC). Tester is UL certified.

| P/N | DESCRIPTION | EACH |
|-----------|---------------------------------------|------|
| DDPTF1001 | Smoke & Heat Detector Test Kit | |
| DDPTF2001 | Smoke, Heat & CO Detector Testing Kit | |
| TS3 | Smoke Capsule, Pkg/3 | |



DDPTF1001



SOLO809



TRUTEST (DDPSOLO100)

INSPECTION, TESTING, AND MAINTENANCE PRODUCTS

Solo™ SMOKE and **HEAT DETECTOR TESTING TOOLS** offer a professional solution to NFPA 72 Inspection, Testing, and Maintenance requirements. The **SOLO808 Starter Kit** provides the equipment necessary to test smoke detectors on ceilings (up to 12'), while the **SOLO809** version increases ceiling access (up to 20'). The **DDPSOLO461 Heat Detector Testing Kit** has everything you need to successfully test heat detectors fast and easy, as does the **TRUTEST Sensitivity Tester System**, which measures the real sensitivity of smoke detectors (as required by the National Fire Code). **SOLOA4 Aerosol** uses a nonflammable, ozone-friendly, and low-residue formula to provide UL listed and manufacturer-endorsed simulated smoke. For hand-held applications, choose **CHEKKIT**, which uses the same detector-friendly formula.

| P/N | DESCRIPTION | EACH |
|------------|---|------|
| SOL0808 | Starter Kit (Includes 330, 108, FTS2, & Carry Bag) For Testing up to 12' | |
| SOL0809 | Starter Kit (Includes 330, 100, FTS2, & Carry Bag) For Testing up to 20' | |
| SOL0823 | Complete Smoke & Heat Detector Testing Kit For Testing up to 30' | |
| DDPSOLO100 | 15' Telescopic Access Pole | |
| DDPSOLO610 | Solo Tech Bag | |
| DDPSOLO461 | Solo Heat Detector Testing Kit For Testing Heat Detectors | |
| TRUTEST* | Smoke Detector Sensitivity Testing System | |



SOLOA4



CHEKKIT

| P/N | DESCRIPTION |
|----------|---|
| SOLOA4 | Smoke Detector Functional Testing Spray |
| CHEKKIT | Smoke Detector Tester, 6 oz |
| SMOKE400 | Aerosol for TruTest Sensitivity Tester |
| SOL0C6 | CO Detector Functional Test Spray |

*ACCESS POLE SOLD SEPARATELY

➔ **More SMOKE AND HEAT DETECTOR TESTING TOOLS Available - Call for Pricing.**



Use Hand Held or With Dispenser

FireTech™ CANNED SMOKE is ideal for checking the functionality of smoke alarms in the widest possible range. It offers efficient testing in a simple-to-use format—hand-held or with use of a dispenser. Plus it provides more tests per can, with fast detector activation. It's also silicone free with no CFCs and uses low GWP propellant. UL/ULC listed.

| P/N | DESCRIPTION |
|------|-------------------------------|
| FTS2 | Smoke Detector Tester, 2.6 oz |



FTS2

SMOKESABRE® is a major step forward in the design of smoke detector test aerosols. When extended, the patented design more effectively vaporizes the aerosol, providing better detector activation, while using less gas per test. Plus the **Sabre** prevents the aerosol from being sprayed too close to the detector, solving the issue of residue build up that plagues other brands of canned smoke.

SmokeSabre contains no silicone, is UL listed, and uses a bio-degradable plastic, making it both recyclable and eco-friendly.

| P/N | DESCRIPTION |
|------------|-----------------------------|
| SMOKESABRE | Smoke Detector Tester, 3 oz |



SMOKESABRE

CANNED AIR is non-flammable, non-residual, and non-abrasive with zero ozone depletion potential. It's also moisture-free and delivers over 80 psi of pressure. Great for cleaning smoke alarms, panels, and office equipment. Comes with plastic delivery tube for hard-to-reach places.

| P/N | DESCRIPTION | EACH |
|--------|---|------|
| AB2000 | Canned Air 2000, 10 oz, (Non-Flammable) | |



AB2000



255

SMOKE ALARM TESTER is great for testing both photo-electric and ionization alarms. Non-toxic, environmentally safe, and offers 100+ bursts. For high, hard-to-reach alarms, try the **DDPN30** with **DDPN59**.

NOTE: Maximum number of extensions is five (34').

| P/N | DESCRIPTION |
|--------|---------------------------------|
| 255 | Smoke Alarm Tester, 2.5½ oz |
| TE1490 | Tester Adapter w/ 18" Extension |
| DDPN30 | 30" Grip & Trigger |
| | Use w/ DDPN59 |
| DDPN59 | 59" Aerosol Extension |
| | Use w/ DDPN30 |



DM73C

Brooks' MULTI-METER measures both AC and DC current and determines continuity of lamps. Unit also has a display locking feature for added convenience.

| P/N | DESCRIPTION | EACH |
|-------|---------------------|------|
| DM73C | Compact Multi-Meter | |





The **DBChecker™** is a **SOUND LEVEL METER** that tests audible appliances for the public operating mode of an emergency voice/alarm system. Easy to use, it conforms to ANSI S1.4 Type 2, which is required by NFPA 72. Measuring levels range from 32 dB to 130 dB, at frequencies between 31.5 Hz to 8 kHz. Unit has two equivalent weighted sound pressure levels (A and C) and displays with a resolution of 0.1 dB on a four-digit LCD screen. 9 volt alkaline battery included.

| P/N | DESCRIPTION | EACH |
|------|-----------------------------|------|
| DB01 | DBChecker Sound Level Meter | |



Put any flame detector to the test with **Flamechecker™**. This microprocessor-based **FLAME SIMULATOR** can test ultraviolet, infrared, or combination flame detectors, per NFPA 72. **Flamechecker** provides a safer environment for testing, because it has no flame.

| P/N | DESCRIPTION | EACH |
|-------------|-----------------|------|
| DDPTFLAME01 | Flame Simulator | |



The **DUCT DETECTOR TEST TOOL** is a battery-operated device that tests the pressure and air sampling ability of duct detectors. Testing of this type should be done once a year, as required by NFPA 72, to make sure the duct detector is sampling the airstream properly. The **Ductchecker®** comes with sampling tube plugs and a hard case to protect the tool from damage. Alkaline 9V battery included.

| P/N | DESCRIPTION | EACH |
|--------|-------------------------------------|------|
| DUCT01 | Ductchecker Duct Detector Test Tool | |



Cellchecker™ LEAD ACID PULSE LOAD BATTERY TESTER provides a comprehensive test of a battery's state of charge and condition. With accurate pulse load testing, it tests the battery's ability to deliver current and to maintain voltage under load, not just voltage or internal resistance. The LED indicates percentages of remaining battery capacity too. With a fast test time (15 seconds), this tester is easy to use, battery safe (does not damage or drain the battery), and produces accurate results on new, partially discharged and stored batteries.

| P/N | DESCRIPTION | EACH |
|--------|---|------|
| CELL03 | Cellchecker Lead Acid Pulse Load Battery Tester | |



The **Gold-Plus BATTERY TESTER** is designed to test the most common 6V (1.2AH to 12AH) and 12V (1.2AH to 100AH) lead acid batteries. Quick and easy to use, it displays DC voltage and AH capacity in seconds. Simply choose the battery type and then press "Test". No confusing conversion rates to worry about either—you get the battery's DC voltage followed by the actual AH capacity. This method is also significantly more accurate than measuring voltage and internal resistance. Plus the **Gold-Plus** does not deplete the battery like conventional load testers.

| P/N | DESCRIPTION | EACH |
|----------|-----------------------|------|
| BACTPLUS | 6V/12V Battery Tester | |



Brooks' state-of-the-art **BATTERY ANALYZERS** help you perform all the necessary service on any fire alarm panel or accessory.

| P/N | DESCRIPTION | EACH |
|----------|---------------------------------|------|
| BBA612 | 6 & 12V Analyzer (Up to 24AH) | |
| BBAC | Compact Carry Case for Analyzer | |
| BBALEADS | Replacement Leads | |

→ **Alarm Panel BATTERIES Available on page 142.**



BBA612

POWER SUPPLIES

Fire-Lite's FCPS24FS6F and **FCPS24FS8F** are compact, cost effective **REMOTE POWER SUPPLIES** that connect to any 12V or 24V **Fire Alarm Control Panel (FACP)** or stand alone. Primary applications include **Notification Appliance Circuit (NAC)** expansion to support ADA requirements and **NAC** synchronization or auxiliary power to support 24V system accessories.

| P/N | DESCRIPTION | EACH |
|------------|---|------|
| FCPS24FS6F | Remote Power Supply/NAC Expander w/ Synch, 6A | |
| FCPS24FS8F | Remote Power Supply/NAC Expander w/ Synch, 8A | |

→ **More FIRE-LITE PRODUCTS Available - Call for Pricing.**



FCPS24FS6F

Required for all new fire alarm installations, this **SYSTEM RECORD DOCUMENTS CABINET** is designed to house all code-required documents. Standard features include 16-gauge steel construction with red powder coat, piano hinge, and key lock. There's also a 2GB USB flash drive for storing electronic files, fire alarm software, and more. Other standard features include key ring hooks, business card holder, CD case, and important notes sticker for the door.

| P/N | DESCRIPTION | H X W X D | EACH |
|-----|--------------------------|--------------------|------|
| FAD | Fire Alarm Documents Box | 13" x 12" x 2 1/4" | |



FAD

FIRE PROTECTIVE SIGNALING CIRCUIT CABLE

Brooks' FIRE ALARM CABLES are designed for use in power-limited installations. Available in twisted, shielded, and unshielded twisted-pairs. **FR Series Cables** are rated NEC Type FPLR and **FP Series Cables** are rated NEC Type FPLP. 1,000' spool.

TYPE FPLR

| P/N | DESCRIPTION | EACH |
|--------|--|------|
| FR182 | 18/2, FPLR, Solid, Twisted, Unshielded | |
| FR162 | 16/2, FPLR, Solid, Twisted, Unshielded | |
| FR142 | 14/2, FPLR, Solid, Twisted, Unshielded | |
| FR182S | 18/2, FPLR, Solid, Twisted, Shielded | |
| FR162S | 16/2, FPLR, Solid, Twisted, Shielded | |

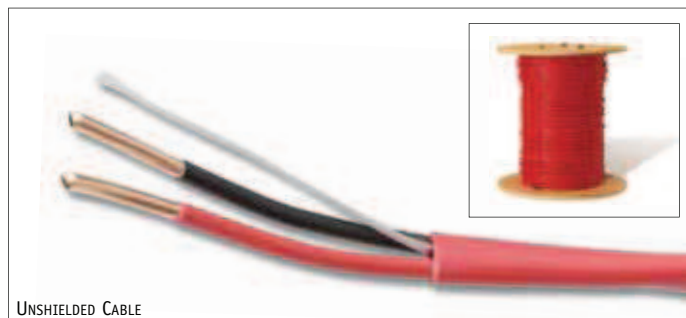

UNSHIELDED CABLE

Type FPLP

| P/N | DESCRIPTION | EACH |
|--------|--|------|
| FP182 | 18/2, FPLP, Solid, Twisted, Unshielded | |
| FP162 | 16/2, FPLP, Solid, Twisted, Unshielded | |
| FP142 | 14/2, FPLP, Solid, Twisted, Unshielded | |
| FP182S | 18/2, FPLP, Solid, Twisted, Shielded | |
| FP162S | 16/2, FPLP, Solid, Twisted, Shielded | |



SHIELDED CABLE

→ **More CABLE PRODUCTS Available - Call for Pricing.**





914E



915

SINGLE/MULTI-STATION SMOKE ALARMS

Kidde's 914E IONIZATION SMOKE ALARM features a test button, power-on LED, and 85 dB alarm horn. Body measures 4" with a 4⁷/₈" mounting plate. Three-year limited warranty. Battery included.

| P/N | DESCRIPTION |
|------|---------------------------|
| 914E | 9V Ionization Smoke Alarm |

Kidde's 915 IONIZATION SMOKE ALARM features a test button, power-on LED, and 85 dB alarm horn. Body measures 5" and is tamper resistant. Ten-year limited warranty. Battery included.

| P/N | DESCRIPTION |
|-----|---------------------------|
| 915 | 9V Ionization Smoke Alarm |



918



9000136

Kidde's 918 IONIZATION SMOKE ALARM includes a test button, power-on LED, and 85 dB alarm horn. Safety light comes on when alarm sounds. Ten-year limited warranty. Battery included.

| P/N | DESCRIPTION |
|-----|---|
| 918 | 9V Ionization Smoke Alarm w/ Safety Light |

Kidde SEALED BATTERY IONIZATION SMOKE ALARMS are totally automatic. And they chirp when they reach their 10-year alarm life. Plus their self-sealed lithium batteries mean 10 years of hassle-free operation, with no battery replacement costs. There's also a **Smart Hush®** feature that temporarily silences nuisance alarms and a four-mode flashing red LED indicator for **Standby, Alarm, Hush, and Memory Set**. Ten-year limited warranty. Battery included.

| P/N | DESCRIPTION |
|---------|--|
| 9000136 | Sealed Battery Smoke Alarm w/ Smart Hush |



21007915

IONIZATION/PHOTOELECTRIC SMOKE ALARMS, from **Kidde**, feature both an ionization and photoelectric sensor, providing the best protection for the home. It is capable of interconnecting with up to 12 **Kidde** smoke alarms on one wiring network. The **Hush®** feature also temporarily silences nuisance alarms. Ten-year limited warranty. Batteries included.

| P/N | DESCRIPTION |
|----------|---|
| 21007915 | 120VAC Ionization/Photoelectric Smoke Alarm w/ Battery Backup |
| 442007 | 9V Ionization/Photoelectric Smoke Alarm |



9120B

The **9120B IONIZATION SMOKE ALARM**, from **BRK®**, are designed to install faster and perform better, with reduced nuisance alarms, which saves time and money. Ten-year limited warranty. Battery included.

| P/N | DESCRIPTION | EACH |
|-------|--|------|
| 9120B | 120VAC Ionization Smoke Alarm w/ 9V Battery Backup | |



Use Individually Or Interconnected



Kidde HARD-WIRED SMOKE ALARMS can be operated as a single station or interconnected with up to 12 **Kidde** smoke alarms on one wiring system. 120VAC. Ten-year limited warranty.

| PN | DESCRIPTION |
|----------|---|
| 21006374 | Ionization, Basic |
| 21006378 | Ionization, 9V Battery Backup |
| 21006376 | Ionization, 9V Battery Backup, Front Loading Battery Door |
| 21006379 | Ionization, Exit Light, 9V Battery Backup |
| SM120X | Relay Power Supply Module |

NEW FEATURES

- Smart Button – one button does it all (Test and Hush).
- Smart Hush® – will temporarily silence nuisance alarms and will not allow hush to be activated unless unit is in alarm.
- Silent Hush® – will not chirp while in hush mode.
- Alarm memory with battery run down protection. Originating alarm flashes red LED, which will shut off to conserve the battery if AC power is not present and the battery voltage drops below 8V.
- Styling features non-yellowing, rigid PVC material.

The **BRK® PHOTOELECTRIC SMOKE ALARM** features a photoelectric smoke sensing chamber, an 85 dB horn, single button test/silence, a green LED power light, and a red LED that indicates the unit is in alarm. Unit includes patented **OptiPath 360 Technology™** for improved performance. Add the relay module for “Smart Interconnect” of **BRK CO** alarms. The **Form-C** contacts, once connected, automatically activates whenever the alarm sounds and will deactivate when the alarm shuts off. Meets UL 217, UL 2034, and UL 539 for accessories. Ten-year limited warranty.

| P/N | DESCRIPTION |
|------|----------------------------------|
| 7010 | 120VAC Photoelectric Smoke Alarm |
| RM4 | BRK Form-C Relay Module |

PHOTOELECTRIC SMOKE ALARMS, from **Kidde**, are excellent for providing early detection against smoke and fire, especially slow, smoldering fires. Alarms feature a low battery indicator. Ten-year limited warranty. Batteries included.

| P/N | DESCRIPTION |
|----------|---|
| 21006371 | 120VAC Photoelectric Smoke Alarm w/ 9V Battery Backup |
| PE9E | 9V Photoelectric Smoke Alarm |

Kidde's HD135F HEAT ALARM is a 120VAC wire-in heat detector with 85 dB sounder and 9V battery backup (battery included) that responds to temperature rather than smoke. Alarm will sound if temperature rises to 135°F. Includes test button and red LED flash. Interconnects with other **Kidde** smoke, CO, and heat alarms. Five-year limited warranty.

| P/N | DESCRIPTION |
|--------|----------------------|
| HD135F | 120VAC Heat Detector |



7010



21006371



HD135F

EACH





Kidde's COMBINATION IONIZATION SMOKE/CO ALARMS feature voice identification, accompanied by an 85 dB alarm. Voice system announces "FIRE! FIRE!" when smoke is detected and "WARNING! CARBON MONOXIDE!" when CO is detected. Test/Reset button allows testing of both smoke and CO sensors. Warning light indicates low battery levels on **COSM. 21006377** interconnects with up to 12 units for smoke alarms and an additional six for CO alarms. Batteries included. Five-year limited warranty.
NOTE: The smoke alarm takes precedence when both smoke and carbon monoxide are detected.

| P/N | DESCRIPTION |
|----------|--|
| COSM | DC Combination Smoke/CO Alarm w/ Batteries |
| 21006377 | 120VAC Interconnectable, Combination Smoke/CO Alarm w/ 9V Battery Backup |
| SM120X | Relay Power Supply Module |



Kidde's front-loading 120VAC **CO/PHOTOELECTRIC SMOKE ALARM**, with 9V battery backup, offers protection against both fire and carbon monoxide in a single unit. It also issues audible warnings—"Fire! Fire!" or "Warning! Carbon Monoxide!". A front-loading battery tray makes replacement simple too. Battery included.

| P/N | DESCRIPTION | EACH |
|------------|---------------------------|------|
| → 21007624 | Combo Photoelectric Alarm | |



Kidde WIRELESS IONIZATION SMOKE ALARM SYSTEMS provide more warning in more places, offering more time to escape. Choose from 120VAC or battery powered alarms. Ten-year limited warranty.

| P/N | DESCRIPTION | EACH |
|------|--|------|
| 919 | DC Wireless Smoke Alarm w/ 3AA Batteries | |
| 1279 | 120VAC Wireless Smoke Alarm | |

In an emergency, this **Kidde STROBE LIGHT** will give hearing-impaired family members or coworkers the visual sign they need to evacuate the building. This bright light flashes to warn them of smoke, heat, or carbon monoxide dangers. Since these devices have no detectors, they must be used in conjunction with existing **Kidde** smoke alarms. Five-year limited warranty.

| P/N | DESCRIPTION | EACH |
|--------|---------------------|------|
| SL177I | 120VAC Strobe Light | |



HEARING IMPAIRED PHOTOELECTRIC SMOKE ALARM, from **Gentex**, meets ADA and UL 1971 requirements. These units come equipped with a patented, three-position functional test switch with pulsing LED sensing chamber and solid-state LED condition indicator. The **710LC** is equipped with a 9' line cord that powers up a 177 candela visual and 90 dB audible signal, all-in-one device. The **7109CSW** is hardwired and has a 9V battery backup with audible low-battery chirp and a tandem connection for up to six detectors per system. One-year limited warranty.

NOTE: Strobe light on the 7109CSW will not function while operating on battery only.

| P/N | DESCRIPTION | EACH |
|---------|--|------|
| 710LC | Hearing Impaired Smoke Alarm w/ 9' Cord | |
| 7109CSW | 120VAC Hearing Impaired Smoke Alarm, Hard-Wired w/ 9V Battery Backup | |



COSM

21007624

1279

SL177I

710LC



CARBON MONOXIDE ALARMS

Kidde's NightHawk™ Deluxe CARBON MONOXIDE ALARM is a direct plug, wall mount, and table-top unit with a 6' cord. The Consumer Product Safety Commission recommends only alarms that meet UL standard 2034, such as **NightHawk** carbon monoxide alarms. Five-year limited warranty. Battery included.

| | | |
|------------|--|-------------|
| P/N | DESCRIPTION | EACH |
| NHDELUXE | Direct-Plug Carbon Monoxide Alarm w/ 9V Battery Backup | |



NHDELUXE



9000234

Kidde's NightHawk™ 9000234 DIRECT-PLUG CARBON MONOXIDE ALARM has a 40% longer life than other CO alarms. It comes with a 9V battery backup and a digital display for continuous, easy viewing. The digital display also adds an advanced level of protection by allowing you to see changes in CO levels in PPM. Sounds an alert when unplugged too. Other features include a **Peak Level Button**, **Test/Reset Button**, and an **End of Life Alarm**, indicating when it's time to replace the unit. Seven-year limited warranty. Battery included.

| | | |
|------------|--|-------------|
| P/N | DESCRIPTION | EACH |
| 9000234 | Direct-Plug Carbon Monoxide Alarm w/ 9V Battery Backup | |



COPB

The battery-powered **CARBON MONOXIDE ALARM**, from **Kidde**, provides early warning via a permanent electro-chemical sensor. Unique features include red and green diagnostic lights, battery status, and sensor health. Five-year limited warranty.

| | | |
|------------|--|-------------|
| P/N | DESCRIPTION | EACH |
| COPB | DC Carbon Monoxide Alarm w/ 3 AA Batteries | |

This **Kidde NightHawk™ COMBINATION CO/GAS ALARM** provides double the protection—detecting CO and explosive gases, like methane or propane. It even has a 9V battery backup in case the lights go out. It's easy to install, too, just plug it in. Other features include a continuous digital display showing detected levels of carbon monoxide and a loud 85 dB pulsing alarm that sounds if a problem is detected. Five-year limited warranty. Battery included.

| | | |
|------------|---|-------------|
| P/N | DESCRIPTION | EACH |
| 9000113 | Direct-Plug Combination Co/Gas Alarm w/ 9V Battery Backup | |



9000113

SMOKE ALARM ACCESSORIES

Energizer® Advanced LITHIUM BATTERIES are 25% lighter and have up to two times longer storage life vs. alkaline. Operating in all temperature extremes (-40°F to 140°F), they can last up to 10 years as a backup in AC-powered smoke detectors. They also comply with ANSI 9V dimensional specs for alkaline and lithium batteries.

| | | |
|------------|--------------------|-------------|
| P/N | DESCRIPTION | EACH |
| 9VLEN | Lithium 9V Battery | |



9VLEN



SDG

SMOKE ALARM GUARD for protection against vandalism and theft. Prohibits battery removal, which would disable the smoke alarm.

| | | |
|------------|--|-------------|
| P/N | DESCRIPTION | EACH |
| SDG | Smoke Alarm Guard, 3 ⁵ / ₈ " x 7 ⁵ / ₈ " | |





Power Rite™ ALARM PANEL BATTERIES are tough, long lasting, and powerful.

| P/N | DESCRIPTION | L X H X W | CASE QTY | EACH | CASE |
|---------------|-------------|--|----------|------|------|
| PRB121 | 12V, 1.3AH | 3 ¹³ / ₁₆ " x 2 ¹ / ₁₆ " x 1 ¹¹ / ₁₆ " | 20 | | |
| PRB124 | 12V, 4AH | 3 ⁹ / ₁₆ " x 4" x 2 ³ / ₄ " | 10 | | |
| PRB127 | 12V, 7AH | 5 ¹⁵ / ₁₆ " x 3 ³ / ₄ " x 2 ⁹ / ₁₆ " | 8 | | |
| PRB1212 | 12V, 12AH | 5 ¹⁵ / ₁₆ " x 3 ¹¹ / ₁₆ " x 3 ⁷ / ₈ " | 4 | | |
| PRB1218 | 12V, 18AH | 7 ¹ / ₈ " x 6 ⁹ / ₁₆ " x 3" | 2 | | |
| → PRB1218NB* | 12V, 18AH | 7 ¹ / ₈ " x 6 ⁹ / ₁₆ " x 3" | 2 | | |
| → PRB1226NB* | 12V, 26AH | 6 ⁹ / ₁₆ " x 4 ¹⁵ / ₁₆ " x 6 ⁷ / ₈ " | 1 | | |
| PRB1226 | 12V, 26AH | 6 ⁹ / ₁₆ " x 4 ¹⁵ / ₁₆ " x 6 ⁷ / ₈ " | 1 | | |
| PRB1233NB* | 12V, 33AH | 7 ¹³ / ₁₆ " x 6 ¹ / ₄ " x 5 ³ / ₁₆ " | 1 | | |
| PRB1255NB* | 12V, 55AH | 9 ¹ / ₁₆ " x 8 ¹ / ₈ " x 5 ⁷ / ₁₆ " | 1 | | |
| → PRB1275NB* | 12V, 75AH | 10 ¹ / ₄ " x 8 ¹ / ₈ " x 6 ⁵ / ₈ " | 1 | | |
| → PRB12100NB* | 12V, 100AH | 12 ⁵ / ₁₆ " x 9 ³ / ₈ " x 6 ⁷ / ₈ " | 1 | | |

*INCLUDES NUT AND BOLT CONNECTION

PRB124

PRB127



Power-Sonic BAT SERIES ALARM PANEL BATTERIES—unparalleled reliability at a reasonable price.

| P/N | DESCRIPTION | L X H X W | CASE QTY | EACH | CASE |
|---------------|-------------|--|----------|------|------|
| BAT125 | 12V, 5AH | 3 ⁹ / ₁₆ " x 4" x 2 ³ / ₄ " | 10 | | |
| BAT127 | 12V, 7AH | 5 ¹⁵ / ₁₆ " x 3 ¹¹ / ₁₆ " x 2 ⁹ / ₁₆ " | 5 | | |
| BAT1218 | 12V, 18AH | 7 ¹ / ₈ " x 6 ⁹ / ₁₆ " x 3" | 2 | | |
| BAT1218NB* | 12V, 18AH | 7 ¹ / ₈ " x 6 ⁹ / ₁₆ " x 3" | 2 | | |
| → BAT1226 | 12V, 26AH | 6 ⁹ / ₁₆ " x 4 ¹⁵ / ₁₆ " x 7" | 1 | | |
| → BAT1233NB | 12V, 33AH | 7 ¹³ / ₁₆ " x 6 ¹ / ₄ " x 5 ³ / ₁₆ " | 1 | | |
| → BAT1255NB* | 12V, 55AH | 9" x 5 ¹ / ₂ " x 8 ¹ / ₈ " | 1 | | |
| → BAT1275NB* | 12V, 75AH | 10 ¹ / ₄ " x 6 ¹¹ / ₁₆ " x 8 ¹ / ₈ " | 1 | | |
| → BAT12100NB* | 12V, 100AH | 12 ⁵ / ₁₆ " x 9 ³ / ₈ " x 6 ⁷ / ₈ " | 1 | | |

*INCLUDES NUT AND BOLT CONNECTION

BAT127



Eagle-Picher, one of the industry's oldest manufacturers of batteries, extends **Brooks'** extensive line of **ALARM PANEL REPLACEMENT BATTERIES**.

| P/N | DESCRIPTION | L X H X W | CASE QTY | EACH | CASE |
|-----------|---------------------|---|----------|------|------|
| CF12V1* | 12V, 1.3AH | 3 ¹³ / ₁₆ " x 2 ¹ / ₁₆ " x 1 ¹ / ₁₆ " | 20 | | |
| CF12V12* | 12V, 12AH | 5 ¹⁵ / ₁₆ " x 3 ³ / ₄ " x 3 ⁷ / ₈ " | 4 | | |
| CF12V18* | 12V, 18AH | 7 ¹ / ₈ " x 6 ⁹ / ₁₆ " x 3" | 2 | | |
| CF12V33L* | 12V, 33AH (Long) | 13 ¹ / ₂ " x 6 ¹ / ₂ " x 3 ¹ / ₈ " | 2 | | |

*WHILE SUPPLIES LAST!

CF12V18



ADAPTER converts nut and bolt terminal to a spade terminal on batteries. Eliminates the need to cut and splice battery leads as well.

NOTE: Fits BAT series only.

| P/N | DESCRIPTION | EACH |
|------|-------------|------|
| NBF2 | Adapter | |



NBF2

NBF2 In Use

SAVE MONEY!

FREE FREIGHT on Batteries Available.
Ask Your Account Manager for Details.





*Technician Training: Classes,
apps, and publications.*

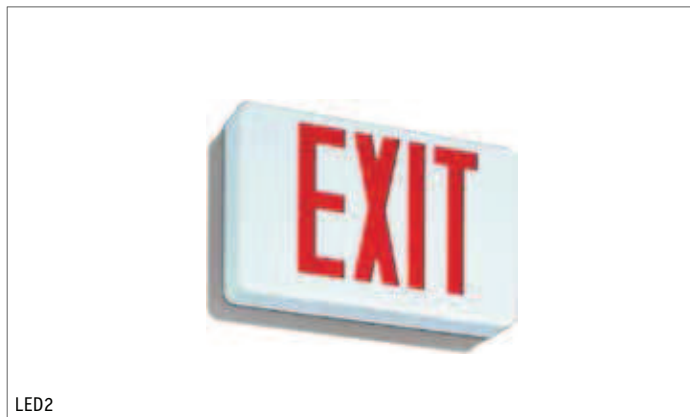

EXIT SIGNS AND EMERGENCY LIGHTS

Brooks' EXIT SIGNS are flame-retardant with high-impact thermoplastic housings. Features include a solid-state charger, universal mounting, test button, low-voltage disconnect, LED indicator, and replaceable pop-out chevrons. Five-year warranty on LED signs. Signs are 120/277VAC.

| P/N | DESCRIPTION | L X H X W |
|-------|---------------------------------------|--|
| LEDAC | Red LED Exit | 12 ³ / ₄ " x 7 ¹ / ₂ " x 1 ³ / ₄ " |
| LED1 | Red LED Exit w/ Battery Backup | 12 ³ / ₄ " x 7 ¹ / ₂ " x 1 ³ / ₄ " |
| LED1B | Red LED Exit w/ Battery Backup, Black | 12 ³ / ₄ " x 7 ¹ / ₂ " x 1 ³ / ₄ " |
| LED6 | Green LED Exit w/ Battery Backup | 12 ³ / ₄ " x 7 ¹ / ₂ " x 1 ³ / ₄ " |

Brooks' STEEL and ALUMINUM EXIT SIGNS are ultra-bright and energy efficient (120/277VAC). Features include solid-state chargers, push-to-test switches, "ON" LED indicators, mounting canopies, and knockout (steel) or self-adhesive (aluminum) chevrons. UL listed for damp locations and meet NFPA 101, NEC, OSHA, and local and state codes. Five-year warranty.

| P/N | DESCRIPTION | L X H X W |
|-------|---|--|
| LED5 | Red LED Exit w/ Battery Backup, Steel Enclosure | 12 ¹ / ₂ " x 8 ⁵ / ₈ " x 2" |
| EDGE1 | Red LED Edge Lit Exit, Aluminum Enclosure | 13 ³ / ₄ " x 11" x 1 ³ / ₄ " |

The **Lithonia EXIT SIGN** features flame-retardant thermoplastic construction and a snap-together design that installs fast. Spare faceplate for double face conversion, universal mounting kit, and knock-out chevrons standard. 120/277 VAC unit with battery backup and a five-year limited warranty. UL listed and meets NFPA, NEC, and OSHA standards.

| P/N | DESCRIPTION | L X H X W |
|------|--------------|---|
| LED2 | Red LED Exit | 11 ³ / ₄ " x 7 ⁷ / ₈ " x 2" |

→ **More EXIT SIGNS Available - Call for Pricing.**

NYC Approved

NEW YORK CITY APPROVED EXIT SIGNS are efficient and easy-to-install. They feature a universal 120/277VAC transformer and energy-saving LEDs. Signs come with universal knockout chevrons and are constructed from 20-gauge steel.

| P/N | DESCRIPTION | L X H X W |
|--------|---|---|
| NYLED1 | Red LED Exit, Steel Enclosure w/ Battery Backup | 14 ¹ / ₂ " x 10 ¹ / ₂ " x 2 ¹ / ₄ " |



Chicago Approved



CHEX



CHEXST

CHICAGO APPROVED EXIT/STAIRS SIGNS are dual voltage 120/277VAC with energy-saving LEDs and a push-to-test switch. Other features include a rechargeable ni-cad battery backup, 20-gauge steel housing, and canopy mounting kit. UL listed and meets UL 924, NFPA 101 Life Safety Code as well as City of Chicago requirements.

| P/N | DESCRIPTION | L X H X W |
|--------|----------------------------|---|
| CHEX | Chicago Red Exit | 12 ¹¹ / ₁₆ " x 9 ⁹ / ₁₆ " x 2 ³ / ₈ " |
| DA | Double Arrows (Glass only) | |
| RA | Right Arrows (Glass only) | |
| LA | Left Arrows (Glass only) | |
| CHEXST | Chicago Red Stairs | 12 ¹¹ / ₁₆ " x 9 ⁹ / ₁₆ " x 2 ³ / ₈ " |
| SWDA | Double Arrows (Glass only) | |
| SWRA | Right Arrows (Glass only) | |
| SWLA | Left Arrows (Glass only) | |

SELF-LUMINOUS EXIT SIGNS require no power to operate, are always on, and always meet code. These tritium-powered signs are available with a 10- or 20-year life. No electricity, batteries, bulbs, wiring, or maintenance involved. Explosion and corrosion proof. Lightweight and easy to install. They meet NFPA 101 standards and are UL listed. Available with gray, white, or black frame. Measures 12³/₄" L x 8¹/₄" H x 1" D. Custom wording available. Call the Sales Department for more information.

NOTE: It is normal for the sign to appear dim during daylight hours. Due to government regulations, these signs must be registered by name and address of end user.

| P/N | DESCRIPTION | EACH |
|-----------|----------------------------------|------|
| DDPSPE10B | 10-Year Sign, Red w/ Black Frame | |
| DDPSPE10G | 10-Year Sign, Red w/ Gray Frame | |
| DDPSPE10W | 10-Year Sign, Red w/ White Frame | |
| DDPSPE20B | 20-Year Sign, Red w/ Black Frame | |
| DDPSPE20G | 20-Year Sign, Red w/ Gray Frame | |
| DDPSPE20W | 20-Year Sign, Red w/ White Frame | |

→ **More SELF-LUMINOUS EXIT SIGNS Available - Call for Pricing.**

EverGlow® PHOTO-LUMINESCENT EXIT SIGNS are non-electrical, affordable, and made of plastic-free aluminum that's certified non-combustible. Available in green or red. Mounting hardware and two self-adhesive chevrons are included. Signs measure 13³/₈" x 8¹/₂".

| P/N | DESCRIPTION |
|----------|---|
| BPLXG | Photo-Luminescent Exit Sign, Green |
| BPLXR | Photo-Luminescent Exit Sign, Red |
| BPLT2X10 | Photo-Luminescent Tape, 1 ¹ / ₂ " x 10m |

Brooks' ALL-WEATHER EXIT SIGN is ideal for industries where water spray or splash is an issue or in high-humidity, oily, corrosive non-hazardous environments. Each unit incorporates low-voltage disconnect, test button, LED indicator, and solid-state charger. Unit is dual voltage (120/277VAC). NEMA4X rated.

| P/N | DESCRIPTION | L X H X W | EACH |
|-------|------------------|--|------|
| LED4X | All-Weather Exit | 13 ³ / ₄ " x 9 ⁹ / ₁₆ " x 3 ⁷ / ₁₆ " | |



DDPSPE10B



BPLXG



LED4X



A Perfect Fit For Tight Spots



LED4MINI

This **Brooks COMBO MICRO LED EXIT SIGN & EMERGENCY LIGHT** features high-impact thermoplastic construction and a snap-fit faceplate. It also comes with field-replaceable chevrons, and a universal mounting knockout for J-boxes. Other features include adjustable, glare-free lighting heads; test switch; status indicator; and ni-cad battery. Dual 120/277VAC and UL listed.

| P/N | DESCRIPTION | L X H X W |
|----------|--|---|
| LED4MINI | Micro Red LED Exit Sign/ Emergency Light | 17 ¹ / ₂ " x 7 ¹ / ₂ " x 2" |



LED10

The innovative and sleek **EXIT & EMERGENCY LIGHT COMBO SIGN**, from **Brooks**, offers a unique design, combining an energy-efficient LED exit sign with a LED emergency light, all in one low-profile unit. Maintenance-free, it has dual voltage with rechargeable ni-cad batteries and can be universally mounted. Meets UL 924, NFPA 101 Life Safety Code, NEC, OSHA, and local and state codes.

| P/N | DESCRIPTION | L X H X W |
|-------|------------------------------|---|
| LED10 | Exit & Emergency Light Combo | 12 ⁹ / ₁₆ " x 9 ¹ / ₈ " x 1 ⁷ / ₈ " |



LED4

Brooks' COMBINATION UNITS meet both exit and emergency lighting needs in one economical unit. The low-profile design comes in a neutral finish, assembled in an injection molded, flame-retardant high-impact thermoplastic housing. Features a solid-state charger, universal mounting, push-to-test switch, low-voltage disconnect, LED indicator, and universal pop-out chevrons. Universal transformer for 120/277VAC operation. Five-year limited warranty.

| P/N | DESCRIPTION | L X H X W |
|--------|--|---|
| LED4 | Red LED Exit/Emergency Light | 23" x 11" x 2 ³ / ₄ " |
| LED4B | Red LED Exit/Emergency Light, Black | 23" x 11" x 2 ³ / ₄ " |
| LED4HO | Remote Capability Red LED Exit/Emergency Light | 23" x 11" x 2 ³ / ₄ " |
| LED7 | Green LED Exit/Emergency Light | 23" x 11" x 2 ³ / ₄ " |



LED4B



NEW YORK CITY APPROVED EXIT/EMERGENCY LIGHTS are efficient and easy to install. They feature a universal 120/277VAC transformer and energy-saving LEDs. Combo units come with universal knockout chevrons and 12W lamp heads. Constructed from 20-gauge steel.

| P/N | DESCRIPTION | L X H X W |
|--------|----------------------------------|---|
| NYLED4 | Red LED Exit/ Emergency Light | 14 ³ / ₈ " x 16 ⁵ / ₈ " x 4 ⁷ / ₈ " |



NYLED4

Brooks' ALL-WEATHER EXIT SIGN and EMERGENCY LIGHT is ideal for industries where water spray or splash is an issue or in high-humidity, oily, corrosive non-hazardous environments. Unit incorporates low-voltage disconnect, test button, LED indicator, and solid-state charger. It's also dual voltage (120/277VAC). NEMA4X rated.

| P/N | DESCRIPTION | L X H X W | EACH |
|------------|--|---|------|
| LED4XCOMBO | Survive-All SVX Series Combo Exit/Emergency Light | 13 ¹ / ₄ " x 12 ⁵ / ₈ " x 4 ⁵ / ₈ " | |



LED4XCOMBO

Brooks' WEATHER-RESISTANT REMOTE HEADS are made for outdoor installations. Heads are fully adjustable, lock into position, and come with gasketed canopies. UL listed.

| P/N | DESCRIPTION | L X H X W | EACH |
|--------|--------------------------|---|------|
| 8RHWR | 6V, 9W Remote Head | 4 ³ / ₄ " x 8 ⁷ / ₈ " x 3 ³ / ₈ " | |
| 9RHWR | 12V, 9W Remote Head | 4 ³ / ₄ " x 8 ⁷ / ₈ " x 3 ³ / ₈ " | |
| 10RHWR | 6V, 9W Remote Twin Head | 12" x 7 ¹ / ₁₆ " x 3 ³ / ₈ " | |
| 11RHWR | 12V, 9W Remote Twin Head | 12" x 7 ¹ / ₁₆ " x 3 ³ / ₈ " | |



8RHWR



10RHWR

Brooks' INCANDESCENT REMOTE HEADS feature flame-retardant thermoplastic construction. Units are fully adjustable and suitable for walls or ceilings.

| P/N | DESCRIPTION | L X H X W |
|------|-------------------------------|---|
| 8RH | 6V, 5.4W Remote Head | 5" x 4 ¹ / ₄ " x 6" |
| 9RH | 12V, 12W Remote Head | 5" x 4 ¹ / ₄ " x 6" |
| 10RH | 6V, 5.4W Twin Remote Heads | 6" x 4 ³ / ₈ " x 5" |
| 11RH | 12V, 12W Twin Remote Heads | 6" x 4 ³ / ₈ " x 5" |



8RH



10RH





BELR3



BELR1

Brooks' EMERGENCY LIGHTS feature a low-profile design in a flame-retardant, high-impact thermoplastic housing. Universal mounting (with "EZ" quick connect), push-to-test switch, solid-state charger, low-voltage disconnect, and power-on LED indicator light standard. Fixed or fully adjustable, glare-free dual lighting heads also included. Universal voltage 120/277VAC **BELR2** has remote capabilities of up to 11 lamp watts. UL listed.

| P/N | DESCRIPTION | L X H X W |
|--------|-----------------------------|--|
| BELR1 | 6V, 10.8W Light | 16" x 5 ¹ / ₈ " x 4 ⁷ / ₈ " |
| BELR1B | 6V, 10.8W Light, Black | 16" x 5 ¹ / ₈ " x 4 ⁷ / ₈ " |
| BELR2 | 6V, 22W Light | 16" x 5 ¹ / ₈ " x 4 ⁷ / ₈ " |
| BELR3 | 6V, 10.8W Fixed Head | 11 ¹³ / ₁₆ " x 5 ¹ / ₈ " x 2 ³ / ₈ " |
| BELR3B | 6V, 10.8W Fixed Head, Black | 11 ¹³ / ₁₆ " x 5 ¹ / ₈ " x 2 ³ / ₈ " |



BELR1LED

Brooks' MINI EMERGENCY LIGHTS feature a contemporary design with premium options in a stylish yet economical package. Lights come standard with fully adjustable, glare-free light heads built in to high-impact thermoplastic housings that are UV stabilized. Their snap-together construction and universal mounting plates make installation a snap, while test switches, status indicators, and ni-cad batteries complete the package. **BELR2LED** has high brightness, remote load capacity. Dual 120/277VAC and UL listed standard.

| P/N | DESCRIPTION | L X H X W |
|----------|-----------------------|--|
| BELR1LED | Mini Emergency Lights | 9 ¹³ / ₁₆ " x 4 ³ / ₄ " x 3" |
| BELR2LED | Mini Emergency Lights | 9 ¹³ / ₁₆ " x 4 ³ / ₄ " x 3" |
| 8RHLED | 3V, 1W Remote Heads | |
| 10RHLED | 3V, 2W Remote Heads | |



BELR5

Brooks' EMERGENCY LIGHTS feature a flame-retardant, high-impact thermoplastic housing. A push-to-test switch, solid-state charger, low-voltage disconnect, and power-on LED indicator light are standard. Fully adjustable, glare-free dual lighting heads also included. Universal voltage 120/277VAC. UL listed.

| P/N | DESCRIPTION | L X H X W |
|-------|----------------|--|
| BELR4 | 6V, 50W Light | 12 ³ / ₄ " x 14 ³ / ₁₆ " x 3 ¹ / ₄ " |
| BELR5 | 12V, 50W Light | 12 ³ / ₄ " x 14 ³ / ₁₆ " x 3 ¹ / ₄ " |

→ **More Brooks' EMERGENCY LIGHTS Available - Call for Pricing.**



CHX

CHICAGO APPROVED EMERGENCY LIGHT features dual voltage 120/277VAC, a push-to-test switch, a rechargeable sealed lead calcium battery, and 20-gauge steel housing. UL listed and meets UL 924, NFPA 101 Life Safety Code as well as City of Chicago requirements.

| P/N | DESCRIPTION | L X H X W |
|-----|---------------|--|
| CHX | 6V, 27W Light | 13" x 11 ¹ / ₂ " x 2 ⁷ / ₈ " |



The **Dual-Lite EZ-2™** is an energy-efficient, compact emergency light that keeps a low profile. It's made from injection-molded, flame-rated white thermoplastic and uses two 6V 5.4W incandescent lamps. **EZ-2** is rated for 120/277 VAC.

| P/N | DESCRIPTION | L X H X W |
|-----|-----------------|--|
| EZ2 | 6V, 10.8W Light | 16 ³ / ₁₆ " x 5 ³ / ₁₆ " x 4 ⁷ / ₈ " |



EZ2

Lithonia EMERGENCY LIGHTING UNITS feature **Krypton** lamps, snap-together construction, and a unique UV-stabilized thermoplastic housing that resists discoloration. **ELM** features high-temperature acrylic lenses with light-directing prismatic pattern for field adjustment. **ELM2** units feature a track and swivel design (**ELM** is fixed) that permits full-range adjustment of lamp heads. All units also have a three-year warranty, dual voltage input of 120/277VAC, and can be mounted on the wall or ceiling. UL Listed.

| P/N | DESCRIPTION | L X H X W |
|------|-----------------------------|---|
| ELM | 6V, 10.8W Light, Fixed Head | 11 ¹ / ₂ " x 5" x 3 ³ / ₄ " |
| ELM2 | 6V, 10.8W Light | 12 ¹ / ₂ " x 5" x 3 ³ / ₄ " |

→ **More Lithonia EMERGENCY LIGHTING UNITS Available - Call for Pricing.**



ELM



ELM2

Brooks' INDUSTRIAL EMERGENCY LIGHTS are manufactured from rugged die-formed steel and feature remote capability, low-voltage disconnect, a push-to-test switch, and an LED indicator. Units are dual voltage. 120/277VAC. 6V unit features 8W Par 36 sealed beam lamps; 12V unit features 12W Par 36 sealed beam lamps. Higher wattage units are available.

| P/N | DESCRIPTION | L X H X W |
|-----------|-----------------|--|
| BRL510 | 6V, 27W Light | 12 ³ / ₄ " x 14 ⁵ / ₈ " x 3 ¹ / ₈ " |
| B12RL1459 | 12V, 54W Light | 13 ³ / ₄ " x 14 ³ / ₈ " x 3 ¹ / ₈ " |
| B12RL1859 | 12V, 110W Light | 16 ¹ / ₈ " x 16 ³ / ₈ " x 5 ⁷ / ₁₆ " |



B12RL1459

NEW YORK CITY APPROVED EMERGENCY LIGHTS are efficient and easy-to-install heavy-duty units. They are completely self-contained and fully automatic. Other features include universal 120/277VAC transformer and PAR36-type lamp heads. All feature 9W lampheads and include LVD (Low Voltage Disconnect), brown-out protection, and rugged 20 gauge steel housings.

| P/N | DESCRIPTION | L X H X W |
|-----------|----------------|---|
| BNY62189 | 6V, 18W Light | 10 ¹ / ₈ " x 15 ⁷ / ₈ " x 2 ¹ / ₂ " |
| BNY63279 | 6V, 27W Light | 14 ¹ / ₂ " x 16 ¹ / ₂ " x 2 ¹ / ₂ " |
| BNY123509 | 12V, 50W Light | 14 ¹ / ₂ " x 16 ¹ / ₂ " x 2 ¹ / ₂ " |



BNY63279





CEW11

The **CEW11 EMERGENCY LIGHT** is completely self-contained with a low-profile design in a white finish. Features include a push-to-test switch, solid-state charger, low-voltage disconnect, and an automatic low-voltage disconnect. Universal transformer for 120/277VAC operation too. Comes with 6V, 7W **MR-16** halogen lamps.

| P/N | DESCRIPTION | L X H X W |
|-------|-----------------|---|
| CEW11 | 6V, 10.8W Light | 13 ³ / ₄ " x 5 ¹ / ₈ " x 3" |



PRO2

Emergi-Lites' Provider™ Series is a low-profile, inconspicuous **EMERGENCY LIGHT**. It features a thermoplastic body and a transparent acrylic lamp shield. Finished in off-white, the **Provider** is suitable for variety of interiors, such as stores, offices, theaters, restaurants, and shopping malls. Mountable in any direction, on a wall, or ceiling. Includes a three-year limited warranty.

| P/N | DESCRIPTION | L X H X W | EACH |
|------|-------------------------|--|------|
| PRO2 | 6V, 12W Emergency Light | 11" x 5" x 5 ¹ / ₂ " | |



BREL4X



BTFX2

Brooks' ALL-WEATHER EMERGENCY LIGHTS are ideal for industries where water spray or splash is an issue or in high-humidity, oily, corrosive non-hazardous environments. Each unit incorporates low-voltage disconnect, test button, LED indicator, and solid-state charger. Units are dual voltage (120/277VAC). **BREL4X** is NEMA4X rated. **BTFX2** is wet location rated.

| P/N | DESCRIPTION | L X H X W | EACH |
|--------|---|---|------|
| BREL4X | NEMA 4X Emergency Light, (2) MR16 Lamps | 17 ³ / ₄ " x 7" x 5 ³ / ₄ " | |
| BTFX2 | All-Weather Light | 8 ³ / ₈ " x 12 ⁷ / ₈ " x 6" | |



FB60

Brooks' EMERGENCY FLUORESCENT PACK provides 700 initial lumens and can power one or two of the existing lamps for a minimum of 90 minutes. Unit contains a battery, charger, and inverter circuit. Mountable in the ballast chamber or on top of the fixture. Powers a single or dual 2'-8' rapid, instant, or energy-saving **T8-T12, HO, or VHO** lamp.

| P/N | DESCRIPTION | EACH |
|------|----------------------------|------|
| FB60 | Emergency Fluorescent Pack | |

ACCESSORIES

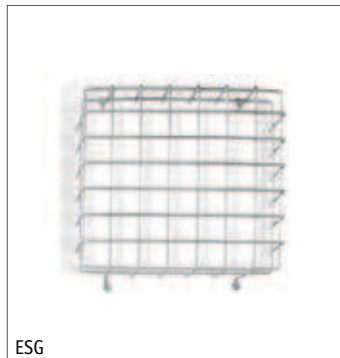

ESG



WG1

| P/N | DESCRIPTION | L X H X W |
|-------|-----------------------------|---|
| ESG | Exit Sign Guard | 13 ⁵ / ₈ " x 13 ⁵ / ₈ " x 4 ¹ / ₂ " |
| WG1* | Guard for BELR & ELM | 13 ¹ / ₂ " x 15" x 6" |
| 3LC | Line Cord, 3' | |
| LENS3 | Red Day-Glo LED Exit Lens | 11 ⁷ / ₈ " x 7 ³ / ₈ " |
| LENS4 | Green Day-Glo LED Exit Lens | 11 ⁷ / ₈ " x 7 ³ / ₈ " |

*Use (2) WG1 WIRE GUARD UNITS FOR EXIT COMBO LIGHTS.



Brooks' WEATHER-RESISTANT REMOTE HEADS

are made for outdoor installations. Heads are fully adjustable, lock into position, and come with gasketed canopies. UL listed.

| P/N | DESCRIPTION | L X H X W | EACH |
|--------|--------------------------|---|------|
| 8RHWR | 6V, 9W Remote Head | 4 ³ / ₄ " x 8 ⁷ / ₈ " x 3 ⁵ / ₈ " | |
| 9RHWR | 12V, 9W Remote Head | 4 ³ / ₄ " x 8 ⁷ / ₈ " x 3 ⁵ / ₈ " | |
| 10RHWR | 6V, 9W Remote Twin Head | 12" x 7 ¹ / ₁₆ " x 3 ⁵ / ₈ " | |
| 11RHWR | 12V, 9W Remote Twin Head | 12" x 7 ¹ / ₁₆ " x 3 ⁵ / ₈ " | |



8RHWR



10RHWR

Brooks' INCANDESCENT REMOTE HEADS feature flame-retardant thermoplastic construction. Units are fully adjustable and suitable for walls or ceilings.

| P/N | DESCRIPTION | L X H X W |
|------|----------------------------|---|
| 8RH | 6V, 5.4W Remote Head | 5" x 4 ¹ / ₄ " x 6" |
| 9RH | 12V, 12W Remote Head | 5" x 4 ¹ / ₄ " x 6" |
| 10RH | 6V, 5.4W Twin Remote Heads | 6" x 4 ³ / ₈ " x 5" |
| 11RH | 12V, 12W Twin Remote Heads | 6" x 4 ³ / ₈ " x 5" |



8RH



10RH

The **ECL230** 9V battery powered **EXIT CONTROL LOCK ALARM**, from **DETEX**[®], is for securing doors that require an alarmed exit device. Its 100 dB alarm sounds in the event of an unauthorized exit. Features a rigid die-cast case, Braille warning, and high-decibel solid-state directional alarm. Alarm is silenced by a control key (included). 9V battery also included. Surface door mount makes it easy to install. Lock cylinder for **EA500** sold separately. ADA compliant and UL listed.

| P/N | DESCRIPTION | EACH |
|---------|---|------|
| ECL230 | Exit Control Lock Alarm | |
| EA500 | Exit Alarm Door Lock | |
| ECL445K | Lock Cylinder Kit for ECL230 | |
| ECL500K | Mortise Cylinder Lock for EA500 | |
| ECLK | Set of 10 Keys for Servicing ECL230 & EA500 | |
| ECLNP | Replacement Nameplate for ECL230 | |
| 9VLEN | Lithium 9V Battery | |



ECL230

STI's EXIT STOPPER[®] deters unauthorized exits or entries through emergency exit doors. Features a highly visible stop-sign and a powerful alarm that sounds a 105 dB warning horn when activated. A key-operated override silences the alarm (included). Housing is made of virtually indestructible polycarbonate. 9V battery included.

| P/N | DESCRIPTION | EACH |
|---------|--------------------|------|
| STI6400 | Exit Stopper | |
| 9VLEN | Lithium 9V Battery | |



EA500



STI6400





REPLACEMENT BATTERIES FOR EXIT AND EMERGENCY LIGHTS

Brooks' NI-CAD REPLACEMENT BATTERY is a direct replacement for **Lithonia's LED Exit Signs** that use a single 1.2V, 1200mAh cell.

| P/N | DESCRIPTION | EACH |
|-----------|---------------------------------|------|
| BELB1201N | 1.2V Ni-Cad Replacement Battery | |



NI-CAD REPLACEMENT PACKS are shipped with flying leads. **NOTE:** Remember to save the connectors from the existing packs so you can splice to the new pack!

| P/N | DESCRIPTION | EACH |
|------------|------------------------|------|
| BNP2700A | 2.4V, 700mAh, Conf. A | |
| BNP2700B | 2.4V, 700mAh, Conf. B | |
| BNP3700A | 3.6V, 700mAh, Conf. A | |
| BNP3700B | 3.6V, 700mAh, Conf. B | |
| BNP4700A | 4.8V, 700mAh, Conf. A | |
| BNP4700B | 4.8V, 700mAh, Conf. B | |
| BNP4700C | 4.8V, 700mAh, Conf. C | |
| BNP4700AA | 4.8V, 800mAh, Conf. AA | |
| BNP5700A | 6V, 700mAh, Conf. A | |
| BNP5700B | 6V, 700mAh, Conf. B | |
| BNP5700DX | 6V, 700mAh, Conf. D | |
| BNP11200WL | 1.2V, 1200mAh | |
| BNP21200A | 2.4V, 1200mAh, Conf. A | |
| BNP41200A | 4.8V, 1200mAh, Conf. A | |
| BNP41200B | 4.8V, 1200mAh, Conf. B | |
| BNP51200A | 6V, 1200mAh, Conf. A | |
| BNP51500B | 6V, 1500mAh, Conf. B | |
| BNP51200B | 6V, 1200mAh, Conf. B | |
| BNP52000AA | 6V, 2000mAh, Conf. AA | |
| BNP52000B | 6V, 2000mAh, Conf. B | |
| BNP52200A | 6V, 2200mAh, Conf. A | |
| BNP52500B | 6V, 2500mAh, Conf. B | |
| BNP54000B | 6V, 4000mAh, Conf. B | |
| BNP54000DX | 6V, 4000mAh, Conf. D | |
| BNP57000B | 6V, 7000mAh, Conf. B | |
| BNP107000C | 12V, 7000mAh, Conf. C | |

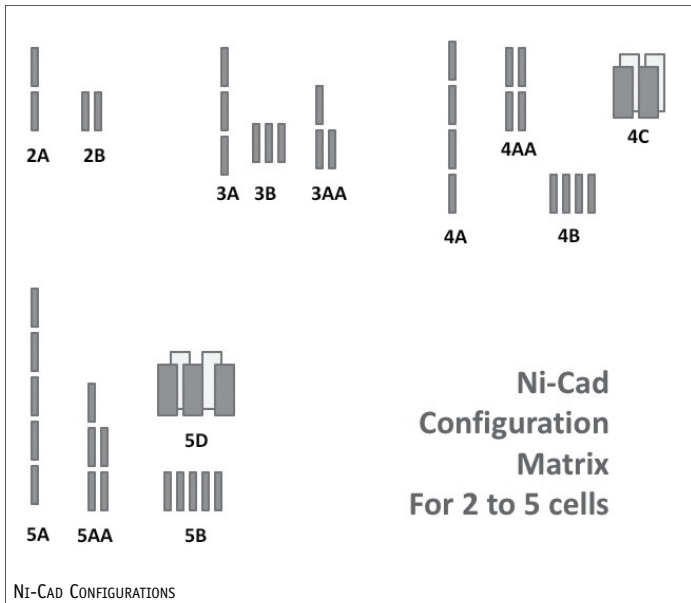

Energizer® Advanced LITHIUM BATTERIES are 25% lighter and have up to two times longer storage life vs. alkaline. Operating in all temperature extremes (-40°F to 140°F), they can last up to 10 years as a backup in AC-powered smoke detectors. They also comply with ANSI 9V dimensional specs for alkaline and lithium batteries.



| P/N | DESCRIPTION | EACH |
|-------|--------------------|------|
| 9VLEN | Lithium 9V Battery | |

The **Eveready® Super Heavy Duty® 6V LANTERN BATTERY** comes from a line of carbon zinc battery products for the price-conscious dealer. **Eveready Super Heavy Duty** is a brand which has powered battery-run devices for over 100 years.

| P/N | DESCRIPTION | EACH |
|------|--------------------|------|
| 466M | 6V Lantern Battery | |



Energizer® Industrial ALKALINE BATTERIES are designed for today's heavy current or continuous use applications, offering long-lasting power over a range of sizes. They operate well in extreme temperatures (0°F-130°F) and boast an excellent shelf life—alkaline cells can be used even after 10 years of storage.

| P/N | DESCRIPTION | EACH |
|--------|----------------------|------|
| ALK92* | AAA Alkaline Battery | |
| ALK91* | AA Alkaline Battery | |
| ALK93 | C Alkaline Battery | |
| ALK95 | D Alkaline Battery | |
| ALK22 | 9V Alkaline Battery | |

*AAA AND AA BATTERIES MUST BE PURCHASED IN QUANTITIES OF 4.



REPLACEMENT BATTERIES

Power Rite® BATTERIES are made in the same factory and the same way as other top name brands, insuring power that lasts.

| P/N | DESCRIPTION | L X H X W | CASE QTY |
|--------|-------------|---|----------|
| PRB64 | 6V, 4.5AH | 2 ³ / ₄ " x 4" x 1 ⁷ / ₈ " | 20 |
| PRB67 | 6V, 7.5AH | 6" x 3 ³ / ₄ " x 1 ³ / ₈ " | 14 |
| PRB612 | 6V, 12AH | 6" x 3 ³ / ₄ " x 2" | 10 |
| PRB623 | 6V, 2.3AH | 1 ¹³ / ₁₆ " x 3" x 1 ⁷ / ₁₆ " | 10 |



PRB64

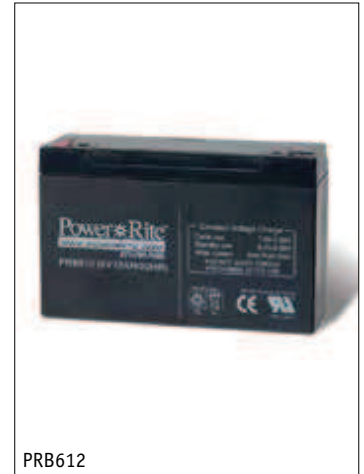

PRB612

Power-Sonic BAT SERIES REPLACEMENT BATTERIES provide unparalleled reliability at a reasonable cost.

| P/N | DESCRIPTION | L X H X W | CASE QTY |
|--------|-------------|--|----------|
| BAT445 | 4V, 4.5AH | 1 ⁷ / ₈ " x 3 ³ / ₄ " x 2 ¹ / ₁₆ " | 20 |
| BAT410 | 4V, 10AH | 4 ¹ / ₁₆ " x 3 ³ / ₄ " x 2" | 10 |
| BAT64 | 6V, 4.5AH | 2 ¹³ / ₁₆ " x 4 ¹ / ₁₆ " x 1 ¹⁵ / ₁₆ " | 20 |
| BAT67 | 6V, 7AH | 6" x 3 ³ / ₄ " x 1 ³ / ₈ " | 10 |
| BAT68 | 6V, 9AH | 3 ⁷ / ₈ " x 4 ¹¹ / ₁₆ " x 2 ¹ / ₄ " | 10 |
| BAT695 | 6V, 12AH | 4 ¹ / ₄ " x 5 ⁹ / ₁₆ " x 2 ³ / ₄ " | 5 |
| BAT612 | 6V, 12AH | 5 ¹⁵ / ₁₆ " x 3 ³ / ₄ " x 2" | 10 |
| BAT620 | 6V, 20AH | 6 ³ / ₁₆ " x 4 ⁷ / ₈ " x 3 ³ / ₁₆ " | 4 |
| BAT636 | 6V, 36AH | 6 ⁷ / ₁₆ " x 6 ¹ / ₂ " x 3 ¹ / ₂ " | 2 |



BAT SERIES BATTERIES

See page 144 for Alarm Batteries.

Eagle-Picher, one of the industry's oldest manufacturers of batteries, extends **Brooks'** extensive lineup of **REPLACEMENT BATTERIES**.

| P/N | DESCRIPTION | L X H X W | CASE QTY |
|---------|-------------|--|----------|
| CF4V4* | 4V, 4.6AH | 1 ⁷ / ₈ " x 1 ⁷ / ₈ " x 4" | 20 |
| CF4V10* | 4V, 9.5AH | 4" x 2" x 3 ³ / ₄ " | 10 |
| CF6V1* | 6V, 1.3AH | 3 ³ / ₁₆ " x 1" x 2 ³ / ₁₆ " | 40 |
| CF6V7* | 6V, 7AH | 5 ¹⁵ / ₁₆ " x 1 ⁵ / ₁₆ " x 3 ⁷ / ₈ " | 10 |
| CF6V10* | 6V, 10AH | 5 ¹⁵ / ₁₆ " x 2" x 3 ¹¹ / ₁₆ " | 10 |
| CF6V33* | 6V, 33AH | 6 ¹ / ₄ " x 3 ³ / ₈ " x 6 ¹ / ₂ " | 1 |

*WHILE QUANTITIES LAST!



0120770



0120707

PURE-LEAD BATTERIES round out **Brooks'** extensive, replacement-battery lineup.

| P/N | DESCRIPTION | L X H X W | CASE QTY |
|---------|-------------|--|----------|
| 0120704 | 4V, 5AH | 3 ³ / ₁₆ " x 3" x 2 ¹ / ₈ " | 24 |
| 0120770 | 4V, 5AH | 2 ¹ / ₂ " x 3 ³ / ₁₆ " x 2 ¹ / ₈ " | 24 |
| 0120705 | 4V, 8AH | 3 ³ / ₁₆ " x 4" x 2 ¹ / ₈ " | 24 |
| 0120706 | 6V, 5AH | 5 ¹ / ₂ " x 3" x 2 ¹ / ₈ " | 16 |
| 0120707 | 6V, 8AH | 5 ¹ / ₂ " x 4" x 2 ¹ / ₈ " | 16 |

Power-Sonic's Gates™-Style replacement **SEALED LEAD ACID BATTERIES** are designed to be a direct substitute for **Gates** monobloc batteries of the same size, voltage, and capacity.

| P/N | DESCRIPTION | L X H X W | CASE QTY |
|--------|-------------|--|----------|
| GSB45 | 4V, 5AH | 3 ³ / ₈ " x 2 ⁷ / ₈ " x 2" | 10 |
| GSB48 | 4V, 8AH | 3 ³ / ₈ " x 4" x 2" | 10 |
| GSB625 | 6V, 2.5AH | 4 ³ / ₁₆ " x 2 ³ / ₄ " x 1 ⁵ / ₈ " | 10 |
| GSB65 | 6V, 5AH | 5 ³ / ₁₆ " x 3" x 2" | 10 |
| GHE625 | 6V, 2.5AH | 4" x 2 ⁵ / ₈ " x 1 ¹ / ₂ " | 24 |
| GSB68 | 6V, 8AH | 5 ³ / ₁₆ " x 4" x 2" | 10 |



GSB45

BATTERY CROSS REFERENCE GUIDE
Online at brooksequipment.com





Power Rite® ALARM BATTERIES are tough, long lasting, and powerful.

| P/N | DESCRIPTION | L X H X W | CASE QTY |
|--------------|-------------|--|----------|
| PRB121 | 12V, 1.3AH | 3 ¹³ / ₁₆ " x 2 ¹ / ₁₆ " x 1 ¹¹ / ₁₆ " | 20 |
| PRB124 | 12V, 4AH | 3 ⁹ / ₁₆ " x 4" x 2 ³ / ₄ " | 10 |
| PRB127 | 12V, 7AH | 5 ¹⁵ / ₁₆ " x 3 ³ / ₄ " x 2 ⁹ / ₁₆ " | 8 |
| PRB1212 | 12V, 12AH | 5 ¹⁵ / ₁₆ " x 3 ¹¹ / ₁₆ " x 3 ⁷ / ₈ " | 4 |
| PRB1218 | 12V, 18AH | 7 ¹ / ₈ " x 6 ⁹ / ₁₆ " x 3" | 2 |
| → PRB1218NB* | 12V, 18AH | 7 ¹ / ₈ " x 6 ⁹ / ₁₆ " x 3" | 2 |
| PRB1226 | 12V, 26AH | 6 ⁹ / ₁₆ " x 4 ¹⁵ / ₁₆ " x 6 ⁷ / ₈ " | 1 |
| → PRB1226NB* | 12V, 26AH | 6 ⁹ / ₁₆ " x 4 ¹⁵ / ₁₆ " x 6 ⁷ / ₈ " | 1 |
| PRB1233NB* | 12V, 33AH | 7 ¹³ / ₁₆ " x 6 ¹ / ₄ " x 5 ³ / ₁₆ " | 1 |
| PRB1255NB* | 12V, 55AH | 9 ¹ / ₁₆ " x 8 ¹ / ₈ " x 5 ⁷ / ₁₆ " | 1 |
| → PRB1275NB* | 12V, 75AH | 10 ¹ / ₄ " x 8 ¹ / ₈ " x 6 ³ / ₈ " | 1 |
| PRB12100NB* | 12V, 100AH | 12 ⁵ / ₁₆ " x 9 ³ / ₈ " x 6 ⁷ / ₈ " | 1 |

*INCLUDES NUT AND BOLT CONNECTION



Power-Sonic BAT SERIES REPLACEMENT BATTERIES—unparalleled reliability at a reasonable price.

| P/N | DESCRIPTION | L X H X W | CASE QTY |
|---------------|-------------|--|----------|
| BAT125 | 12V, 5AH | 3 ⁹ / ₁₆ " x 4" x 2 ³ / ₄ " | 10 |
| BAT127 | 12V, 7AH | 5 ¹⁵ / ₁₆ " x 3 ¹¹ / ₁₆ " x 2 ⁹ / ₁₆ " | 5 |
| BAT1218 | 12V, 18AH | 7 ¹ / ₈ " x 6 ⁹ / ₁₆ " x 3" | 2 |
| BAT1218NB* | 12V, 18AH | 7 ¹ / ₈ " x 6 ⁹ / ₁₆ " x 3" | 2 |
| → BAT1226 | 12V, 26AH | 6 ⁹ / ₁₆ " x 4 ¹⁵ / ₁₆ " x 7" | 1 |
| → BAT1233NB* | 12V, 33AH | 7 ¹³ / ₁₆ " x 6 ¹ / ₄ " x 5 ³ / ₁₆ " | 1 |
| → BAT1255NB* | 12V, 55AH | 9 ¹ / ₁₆ " x 8 ¹ / ₈ " x 5 ⁷ / ₁₆ " | 1 |
| → BAT1275NB* | 12V, 75AH | 10 ¹ / ₄ " x 8 ¹ / ₈ " x 6 ³ / ₈ " | 1 |
| → BAT12100NB* | 12V, 100AH | 12 ⁵ / ₁₆ " x 9 ³ / ₈ " x 6 ⁷ / ₈ " | 1 |

*INCLUDES NUT AND BOLT CONNECTION

Eagle-Picher, one of the industry's oldest manufacturers of batteries, extends **Brooks'** extensive lineup of **REPLACEMENT BATTERIES**.



| P/N | DESCRIPTION | L X H X W | CASE QTY |
|-----------|------------------|---|----------|
| CF12V1* | 12V, 1.3AH | 3 ¹³ / ₁₆ " x 2 ¹ / ₁₆ " x 1 ¹ / ₁₆ " | 20 |
| CF12V4* | 12V, 4.5AH | 3 ⁹ / ₁₆ " x 4" x 2 ³ / ₄ " | 10 |
| CF12V7* | 12V, 7.2AH | 5 ¹⁵ / ₁₆ " x 3 ³ / ₄ " x 2 ⁹ / ₁₆ " | 5 |
| CF12V12* | 12V, 12AH | 5 ¹⁵ / ₁₆ " x 3 ³ / ₄ " x 3 ⁷ / ₈ " | 4 |
| CF12V18* | 12V, 18AH | 7 ¹ / ₈ " x 6 ⁹ / ₁₆ " x 3" | 2 |
| CF12V26* | 12V, 26AH | 6 ¹ / ₂ " x 4 ⁷ / ₈ " x 6 ⁷ / ₈ " | 1 |
| CF12V33U* | 12V, 33AH | 7 ¹¹ / ₁₆ " x 6 ¹ / ₄ " x 5 ¹ / ₈ " | 1 |
| CF12V33C* | 12V, 33AH (Sq) | 6 ³ / ₄ " x 6 ¹ / ₂ " x 6 ¹ / ₄ " | 2 |
| CF12V33L* | 12V, 33AH (Long) | 13 ¹ / ₂ " x 6 ¹ / ₂ " x 3 ¹ / ₈ " | 2 |

*WHILE QUANTITIES LAST!

FREE FREIGHT on Batteries Available. Ask Your Account Manager for Details.



ADAPTER converts nut and bolt terminal to a spade terminal on batteries. Eliminates the need to cut and splice battery leads.

| P/N | DESCRIPTION | EACH |
|------|-------------|------|
| NBF2 | Adapter | |

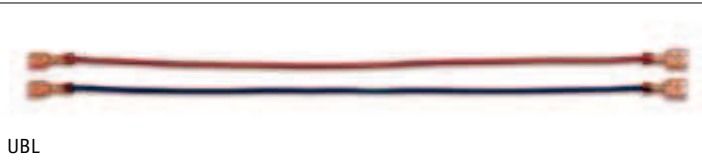

BATTERY LEADS

| P/N | DESCRIPTION | EACH |
|-----|-------------------------------|------|
| UBL | Universal Battery Lead, Pkg/2 | |
| PBL | Plug Battery Lead | |

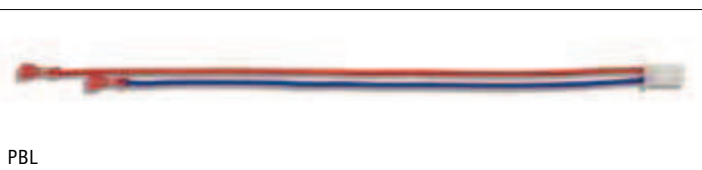

REPLACEMENT LAMPS

Replacement **LAMPS** for exit signs and emergency lighting.

| P/N | DESCRIPTION |
|----------|--|
| B170 | 4V, 7.2W Dbl. Contact Bayonet (11-170) |
| B914 | 4V, 3.6W Miniature Wedge (914) |
| B909 | 6V, 3.7W Miniature Wedge (909) |
| B939 | 6V, 5.4W Miniature Wedge (939) |
| B927 | 6V, 7.2W Miniature Wedge (927) |
| BMR16 | 6V, 5W MR-16 Halogen |
| BELPL149 | 6V, 5.4W MR-24 Replacement Lamp for ELM2 |
| BT82 | 6V, 6.63W Dbl. Contact Bayonet (11-082) |
| B47 | 6.3V, 9W Single Contact Bayonet (47T3.25) |
| BGE90 | 13V, 7.5W DC Bayonet Lamp |
| B915 | 12V, 9W Miniature Wedge (915) |
| B912 | 12V, 12.8W Miniature Wedge (912) |
| P/N | DESCRIPTION |
| BF6T5 | 120V, 6W Miniature Bi-Pin (F6T5) |
| BF8T5 | 120V, 8W Miniature Bi-Pin (F8T5) |
| B7C7 | 120V, 7W Candelabra Screw (7C7) |
| P/N | DESCRIPTION |
| BT65DC | 120V, 20W Dbl. Contact Bayonet (20T6.5) |
| BT65S | 120V, 20W Intermediate Screw (20T6.5) |
| BT65SF | 120V, 20W Intermediate Screw, Frosted (20T6.5) |
| B25T10 | 120V, 25W Medium Screw Base (25T10) |
| BT6 | 145V, 15W Candelabra Screw (15T6) |

FLUORESCENT LAMPS for exit signs and emergency lighting.

| P/N | DESCRIPTION |
|------|------------------------------------|
| BPL5 | 120V, 5W Compact Fluorescent (PL5) |
| BPL7 | 120V, 7W Compact Fluorescent (PL7) |
| BPL9 | 120V, 9W Compact Fluorescent (PL9) |

SEALED BEAM LAMPS for emergency lighting.

| P/N | DESCRIPTION |
|--------|----------------------------------|
| B7613 | 6V, 8W Sealed Beam Lamp |
| BH7555 | 12V, 8W Halogen Sealed Beam Lamp |
| B4044 | 12V, 12W Sealed Beam Lamp |
| B4446 | 12.8V, 25W Sealed Beam Lamp |

Brooks' LED RETROFIT KIT comes complete with two LED lamps, two intermediate base adapters, two double contact base adapters, and two **DayGlo** lenses (for use on 120VAC circuits only). Five-year warranty with 50,000-hour life expectancy. **NOTE:** Call the Sales Dept. for 277VAC applications.

| P/N | DESCRIPTION | EACH |
|---------|--|------|
| BLRKITR | Red LED Retrofit Lamps w/ Bases, Pkg/2 | |
| BLRKITG | Green LED Retrofit Lamps w/ Bases, Pkg/2 | |

Watt-Man™ RED LED (120VAC) retrofit exit sign lamps use only 1W of energy. Lamps feature unbreakable polycarbonate construction, solid-state electronics, and surge protection. Five-year warranty with 50,000-hour life expectancy.

| P/N | DESCRIPTION | SIZE | EACH |
|-----|--|---------------------------------|------|
| WS1 | Candelabra Screw Base, Pkg/2 | 3 ³ / ₄ " | |
| WS3 | Intermediate Screw Base, Pkg/2 | 3 ³ / ₄ " | |
| WS7 | Fluorescent PL Base | 3 ³ / ₄ " | |
| SAS | Socket and Adapter Set Bayonet & Intermediate | | |
| MBA | Intermediate to Medium Base Adapter | 3 ³ / ₄ " | |

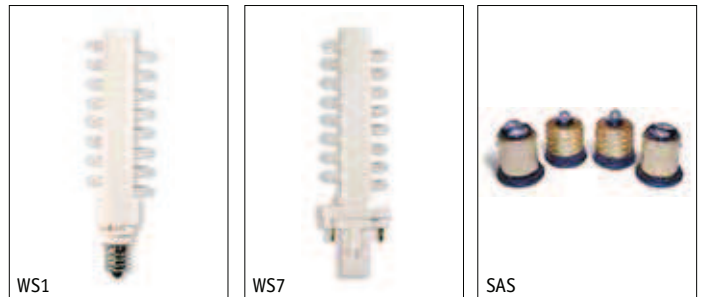
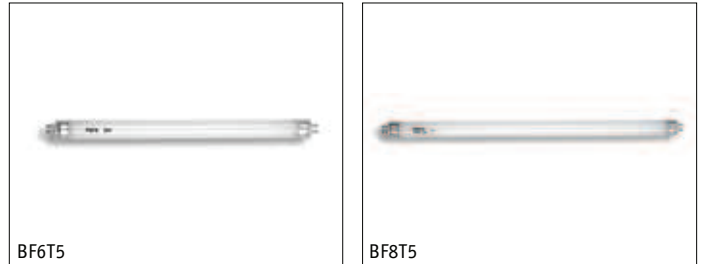

EXIT AND EMERGENCY LIGHTING TEST EQUIPMENT

The **Gold-Plus BATTERY TESTER** is designed to test the most common 6V (1.2AH to 12AH) and 12V (1.2AH to 100AH) lead acid batteries. Quick and easy to use, it displays DC voltage and AH capacity in seconds. Simply choose the battery type and then press "Test". No confusing conversion rates to worry about either—you get the battery's DC voltage followed by the actual AH capacity. This method is also significantly more accurate than measuring voltage and internal resistance. Plus the **Gold-Plus** does not deplete the battery like conventional load testers.

| P/N | DESCRIPTION | EACH |
|------------|-----------------------|------|
| → BACTPLUS | 6V/12V Battery Tester | |

For exit sign and emergency light service testing, **Brooks'** line of **BATTERY ANALYZERS** also check charging circuitry. Equipped with leads.

| P/N | DESCRIPTION | EACH |
|----------|--|------|
| BBA64 | 4 & 6V Analyzer (Up to 24AH) | |
| BBA612 | 6 & 12V Analyzer (Up to 24AH) | |
| BBAC | Compact Carry Case for Analyzer | |
| BBALEADS | Replacement Leads for Brooks Battery Analyzers | |

The **NON-CONTACT VOLTAGE PROBE** is designed for safety and limited troubleshooting with its three-way voltage alert—beeps, lights, and vibrates. It uses a non-contact method of AC voltage testing and determines if AC voltage is present without touching wires or opening lock nuts. Totally insulated, the **Voltage Probe** has no exposed metal or conductive parts and is CAT IV rated 1,000V.

| P/N | DESCRIPTION | EACH |
|---------|---------------------------|------|
| VP600SB | Non-Contact Voltage Probe | |

Brooks' MULTI-METER is a versatile and compact unit that will measure both AC and DC current and determine continuity of lamps. Unit also has a display locking feature.

| P/N | DESCRIPTION | EACH |
|-------|---------------------|------|
| DM73C | Compact Multi-Meter | |

Use either the non-conductive plastic **EMERGENCY LIGHT TEST BUTTON PICK** or heavy-duty glass **STRAPPING TAPE** to engage and hold down the test button on exit and emergency lights.

| P/N | DESCRIPTION | EACH |
|-------|---|------|
| BPICK | Emergency Light Test Button Pick, Pkg/250 | |
| GST | Strapping Tape, 1.88" x 12 yds | |



NEW

BACTPLUS



BBA64



BBA612



VP600SB



DM73C



BPICK

BPICK In Use



MISCELLANEOUS

The **Step 'N Store® TOOL BOX** is made of sturdy co-polymer that will support up to 325 lbs. Features a sure-grip large carry handle, a handy tote tray, plus a deep-bottom storage area for supplies and tools. Manufacturer's lifetime warranty. Lockable.

| | | | |
|------------|------------------------|---------------------|-------------|
| P/N | DESCRIPTION | H X W X D | EACH |
| SSB20 | Step 'N Store Tool Box | 12 1/2" x 20" x 14" | |

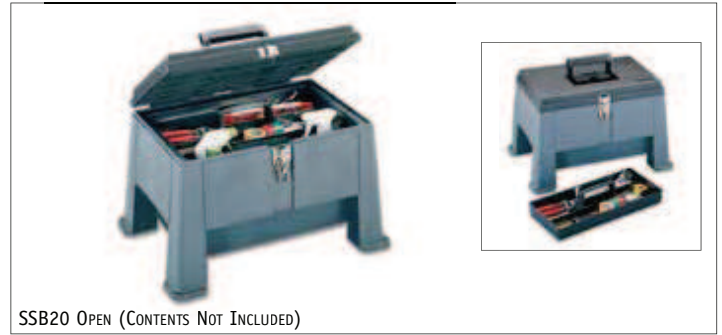

SSB20 OPEN (CONTENTS NOT INCLUDED)

LIGHTING SERVICE LABELS provide a service record for customers and local authorities. Order blank or with custom information, including company name, address, and phone number. Labels measure 3 1/2" x 1 3/4". Priced and sold per 100. Blank labels are sold by the roll; custom labels require a three-roll minimum order.

| | | |
|------------|---------------------------------------|-------------|
| P/N | DESCRIPTION | EACH |
| ELTLBK | Emergency Lighting Test Label, Blank | |
| SSPELTL | Emergency Lighting Test Label, Custom | |



SSPELTL

Crescent® WIRE CUTTER is made of strong alloy tool steel with hardened cutting edges. Includes non-slip cushion grips.

| | | |
|------------|--------------------|-------------|
| P/N | DESCRIPTION | EACH |
| TL0436 | 6" Wire Cutter | |



TL0436

WIRING TOOL features specially heat-treated blades for long life and **Channellock-Blue®** comfort grip handles.

| | | |
|------------|--------------------|-------------|
| P/N | DESCRIPTION | EACH |
| TL908 | Wiring Tool | |



TL908

BATTERY LEADS

| | | |
|------------|-------------------------------|-------------|
| P/N | DESCRIPTION | EACH |
| UBL | Universal Battery Lead, Pkg/2 | |
| PBL | Plug Battery Lead | |

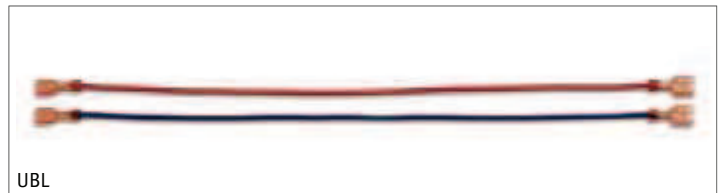

UBL

These are standard twist-on and crimp-type wire **CONNECTORS**.

| | | | |
|------------|--|----------------|-------------|
| P/N | DESCRIPTION | PKG QTY | EACH |
| IFD16 | Insulated Female Disconnect, 16/14 AWG Fits 3/16" Tab | 50 | |
| IFD22 | Insulated Female Disconnect, 22/18 AWG Fits 3/16" Tab | 50 | |
| WC018 | Orange Wire Connector, 18/14 AWG | 100 | |
| VBS16 | Vinyl Butt Splice, 16/14 AWG | 50 | |

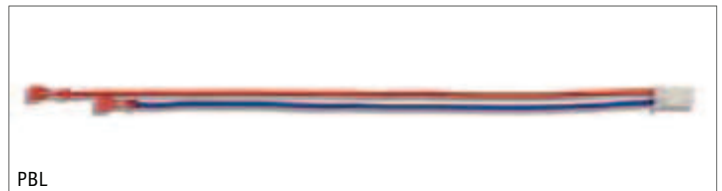

PBL



IFD16

WCG22

WC018

VBS16

For Additional Tools, See Section 10.



EXIT AND EMERGENCY LIGHTING CROSS REFERENCE

EXIT SIGNS

| P/N | BATTERY BACKUP | REPLACEMENT BATTERY | LIGHT SOURCE | REPLACEMENT LAMPS AC | REPLACEMENT LAMPS DC | UL LISTED | ETL LISTED |
|--------|----------------|---------------------|--------------|----------------------|----------------------|-----------|------------|
| CHEX | Yes | | | | | | |
| SCES1 | Yes | PRB64 | Incandescent | B7C7 | B909 | UL | ETL |
| SCES3 | Yes | PRB64 | Incandescent | B7C7 | B909 | UL | ETL |
| ESR1 | No | No Battery | Incandescent | B7C7 | None | UL | ETL |
| ESR3 | No | No Battery | Incandescent | B7C7 | None | - | ETL |
| LEDAC | No | - | LED | Replace Unit | - | UL | - |
| LED1 | Yes | Must Call | LED | Replace Unit | - | UL | - |
| LED1B | Yes | Must Call | LED | Replace Unit | - | UL | - |
| LED5 | Yes | Must Call | LED | Replace Unit | - | - | ETL |
| LED6 | Yes | Must Call | LED | Replace Unit | - | UL | - |
| ESR2 | No | No Battery | Incandescent | BT6 | None | UL | - |
| SCES2 | Yes | PRB64 | Incandescent | BT6 | B909 | UL | - |
| LED2 | Yes | BELB1201N | LED | Replace Unit | - | UL | - |
| EDGE1 | Yes | Must Call | LED | Replace Unit | - | - | - |
| LED4X | Yes | Must Call | LED | Replace Unit | - | UL | - |
| LED10 | Yes | BNP47006(2) | LED | Replace Unit | None | UL | - |
| NYLED1 | Yes | 3.6V 700mAh | LED | Must call | Must call | UL | - |

COMBINATION EXIT SIGNS

| P/N | BATTERY BACKUP | REPLACEMENT BATTERY | LIGHT SOURCE | REPLACEMENT LAMPS AC | DC EXIT | HEADS | UL LISTED | ETL LISTED |
|------------|----------------|---------------------|--------------|----------------------|--------------|---------|-----------|------------|
| CXEL1 | Yes | PRB67 | Incandescent | B7C7 | B909 | B909 | - | ETL |
| CXEL3 | Yes | PRB67 | Incandescent | B7C7 | B909 | B909 | - | ETL |
| LED3 | Yes | PRB67 | LED | Replace Unit | B909 | B909 | - | - |
| CXEL2 | Yes | PRB67 | Incandescent | BT6 | B909 | B939 | UL | - |
| LED4 | Yes | PRB67 | LED | Replace Unit | B909 | B939 | UL | - |
| LED4MINI | Yes | BP700-3D | LED | Replace Unit | Replace Unit | Replace | UL | - |
| LED4B | Yes | PRB64 | LED | Must call | Must call | B939 | UL | - |
| LED4HO | Yes | PRB65 | LED | Must call | Must call | B940 | UL | - |
| LED7 | Yes | PRB67 | LED | Replace Unit | B909 | B939 | UL | - |
| LED4XCOMBO | Yes | Must Call | LED | Replace Unit | BMR16 | BMR16 | UL | - |
| NYLED4 | Yes | PRB612 | LED | Must call | Must call | B941 | UL | - |

EMERGENCY LIGHTS

| P/N | BATTERY BACKUP | REPLACEMENT BATTERY | REPLACEMENT LAMPS | VOLTS/WATTS | REMOTE LAMPHEAD CAPABILITY | UL LISTED | ETL LISTED |
|------------|----------------|---------------------|-------------------|-------------|----------------------------|-----------|------------|
| BELR1 | Yes | PRB64 | B939 | 6V, 5.4W | No | UL | - |
| BELR1B | Yes | PRB64 | B939 | 6V, 5.4W | No | UL | - |
| BELR1LED | Yes | BP700-3D | Replace Unit | - | No | UL | - |
| BELR2 | Yes | PRB67 | B939 | 6V, 5.4W | 2-8RH or 1-10RH | UL | - |
| BELR2LED | Yes | BP700-3D | Replace Unit | - | Yes | UL | - |
| BELR3 | Yes | PRB64 | B939 | 6V, 5.4W | No | UL | ETL |
| BELR4 | Yes | 2-PRB612-P | B927 | 6V, 7.2W | 6-8RH or 3-10RH | UL | - |
| BELR5 | Yes | 2-PRB612-S | B915 | 12V, 9W | 2-9RH or 1-11RH | UL | - |
| CEW11 | Yes | PRB64 | None | 6V, 7W | No | UL | - |
| CHX | Yes | PRB612 | Must call | 6V, 12W | No | UL | - |
| ELM (NEW) | Yes | PRB64 | BELPL149 | 6V, 5.4W | No | UL | - |
| ELM (OLD) | Yes | PRB64 | B939 | 6V, 5.4W | No | UL | - |
| ELM2 (NEW) | Yes | PRB64 | BELPL149 | 6V, 5.4W | No | UL | - |
| ELM2 (OLD) | Yes | PRB64 | B939 | 6V, 5.4W | No | UL | - |
| ELM4 | Yes | 2-PRB612-S | B912 | 12V, 12W | 2-9RH or 1-11RH | UL | - |
| ELM1254 | Yes | 2-PRB612-S | B912 | 12V, 12W | 2-9RH or 1-11RH | UL | - |
| ELM627 | Yes | PRB67 | B927 | 6V, 7.2W | 2-8RH or 1-10RH | UL | - |
| 6ELM2P | Yes | PRB67 | B927 | 6V, 7.2W | 2-8RH or 1-10RH | UL | - |
| EZ2 | Yes | Must call | Must call | Must call | No | UL | - |
| LZ2 | Yes | PRB64 | BMR16 | 6V, 5.4W | No | UL | - |
| LED3B | - | - | - | - | - | - | - |
| PRO2 | Yes | PRB64 | B939 | 6V, 5.4W | No | UL | - |
| BNY62189 | Yes | PRB67 | Must call | 6V, 9W | No | UL | - |
| BNY63279 | Yes | PRB610 | Must call | 6V, 9W | No | UL | - |
| BNY123509 | Yes | PRB610 | Must call | 12V, 9W | 14W | UL | - |
| BTFX2 | Yes | PRB64 | B927 | 6V, 7.2W | No | UL | - |
| BRL510 | Yes | PRB612 | B7613 | 6V, 8W | 1-8RH | UL | - |
| B12RL1459 | Yes | 2-PRB612-S | B4044 | 12V, 12W | 2-9RH or 1-11RH | UL | - |
| B12RL1859 | Yes | 3-PRB612-S | B4044 | 12V, 12W | 6-9RH or 3-11RH | UL | - |
| BREL4X | Yes | PRB67 | BMR16 | 6V 6 W | No | UL | - |

BATTERY CROSS REFERENCE GUIDE
Available on page 142 or online at brooksequipment.com





*Industry Associations:
Working hand and hand.*

Sign Up With Brooks!



VINYL SIGNS (SELF-ADHESIVE)

SELF-ADHESIVE VINYL SIGNS and **LABELS** are silk screened with UV inks, then clear laminated for durability and fade resistance. Mounting surface must be clean, dry, smooth, and non-porous. To mount these on a porous surface, such as brick or concrete block, use our **Sign On!** aerosol adhesive.

ALUMINUM SIGNS

ALUMINUM SIGNS are silk screened, then oven baked for added durability. They also have smooth, finished edges; rounded corners; and pre-drilled mounting holes. Ideal for mounting on porous surfaces, such as concrete block or brick.

RIGID PLASTIC SIGNS

RIGID PLASTIC SIGNS are screen printed with UV inks on both sides. Rigid, tough plastic (1/32" thick) with keyhole slots for easy perpendicular wall mounting.



FIRE EXTINGUISHER SIGNS

VINYL SIGNS

| P/N | DESCRIPTION | L X H |
|--------|--|-------------------|
| BL107 | "Fire Extinguisher" Arrow | 12" x 8" |
| BL108 | "Fire Extinguisher" Arrow | 4" x 12" |
| BL109 | "Fire Extinguisher" Arrow | 4" x 18" |
| BL109S | Spanish "Extintor" Arrow | 4" x 18" |
| BL114 | "Fire Extinguisher" Arrow | 8" x 12" |
| BL120 | "Fire Extinguisher" | 12" x 4 1/2" |
| BL127 | Wrap Around Column or Pole | 24 1/2" x 12 1/2" |
| BL132 | "Fire Extinguisher" Arrow | 4" x 4" |
| BL189 | "Extinguisher Missing" | 12" x 8" |
| | K-Class "Fire Extinguisher" Arrow, Bilingual | |



ALUMINUM SIGNS

| P/N | DESCRIPTION | L X H |
|------|---------------------------|----------|
| A107 | "Fire Extinguisher" Arrow | 12" x 8" |
| A108 | "Fire Extinguisher" Arrow | 4" x 12" |
| A109 | "Fire Extinguisher" Arrow | 4" x 18" |
| A114 | "Fire Extinguisher" Arrow | 8" x 12" |



RIGID PLASTIC SIGNS

| P/N | DESCRIPTION | L X H |
|-------|--|----------|
| RP107 | "Fire Extinguisher" Arrow | 12" x 8" |
| RP108 | "Fire Extinguisher" Arrow | 4" x 12" |
| RP109 | "Fire Extinguisher" Arrow | 4" x 18" |
| RP114 | "Fire Extinguisher" Arrow | 8" x 12" |
| RP189 | K-Class "Fire Extinguisher" Arrow, Bilingual | 8" x 12" |



ALUMINUM 90° ANGLE SIGNS

| P/N | DESCRIPTION | L X H |
|--------|---------------------------|----------|
| AWM108 | "Fire Extinguisher" Arrow | 4" x 12" |
| AWM109 | "Fire Extinguisher" Arrow | 4" x 18" |
| AWM114 | "Fire Extinguisher" Arrow | 8" x 12" |

RIGID PLASTIC 90° ANGLE SIGNS

| P/N | DESCRIPTION | L X H |
|--------|---------------------------|----------|
| PWM108 | "Fire Extinguisher" Arrow | 4" x 12" |
| PWM109 | "Fire Extinguisher" Arrow | 4" x 18" |
| PWM114 | "Fire Extinguisher" Arrow | 8" x 12" |

3-D RIGID PLASTIC ANGLE SIGNS

| P/N | DESCRIPTION | L X H |
|---------|--------------------------------------|-----------|
| PTD108 | "Fire Extinguisher" Arrow | 4" x 12" |
| PTD109 | "Fire Extinguisher" Arrow | 4" x 18" |
| PTD182 | "Fire Extinguisher" Arrow | 5" x 6" |
| PTD109B | "Fire Extinguisher" Arrow, Bilingual | 11" x 18" |



FIRE EXTINGUISHER INSIDE SIGNS

VINYL SIGNS

| P/N | DESCRIPTION | L X H |
|-------|----------------------------|----------|
| BL105 | "Fire Extinguisher Inside" | 4" x 4" |
| BL116 | "Fire Extinguisher Inside" | 6" x 9" |
| BL172 | "Fire Extinguisher Inside" | 4" x 3" |
| BL183 | "Fire Extinguisher Inside" | 18" x 2" |



FIRE EXTINGUISHER CABINET SIGNS

VINYL SIGNS

| P/N | DESCRIPTION | L X H |
|---------|---|---|
| BL130 | Reversed "In Case Of Fire Break Front" | 4 ³ / ₄ " x 1 ¹ / ₂ " |
| BL123 | "Warning \$500 Fine..." | 4" x 4" |
| BL128 | "Warning...Electronic Alarm" | 6" x 2" |
| BL106 | "Fire Extinguisher-In Case Of Fire Break Glass" | 6" x 2" |
| BL135R | Red "Fire" Die-Cut | 3" x 8 ¹ / ₂ " |
| BL135W* | White "Fire" Die-Cut | 3" x 8 ¹ / ₂ " |
| BLM12* | "Pull Here..." | 4" x 2 ¹ / ₂ " |

*WHILE QUANTITIES LAST!



SIGN ADHESIVE

Sign On! ADHESIVE.

| P/N | DESCRIPTION |
|-----|---------------------------|
| BA1 | Sign On! Aerosol Adhesive |

EACH



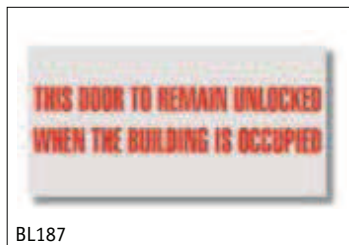

SMOKING SIGNS

VINYL SIGNS

| P/N | DESCRIPTION | L X H |
|-------|----------------------------|----------|
| BL110 | "No Smoking" | 12" x 4" |
| BL115 | "No Smoking" | 8" x 10" |
| BL174 | "No Smoking..." w/ Picture | 8" x 5" |

ALUMINUM SIGNS

| P/N | DESCRIPTION | L X H |
|------|-------------------------|----------|
| A115 | "No Smoking" w/ Picture | 8" x 10" |
| A110 | "No Smoking" | 12" x 4" |

RIGID PLASTIC SIGNS

| P/N | DESCRIPTION | L X H |
|-------|------------------------------------|----------|
| RP115 | "No Smoking" w/ Picture | 8" x 10" |
| RP140 | "Danger No Smoking" | 8" x 10" |
| RP194 | "Smoking Permitted ..." w/ Picture | 8" x 10" |

EXIT SIGNS AND DIRECTIONAL ARROWS

SELF-ADHESIVE VINYL SIGNS

| P/N | DESCRIPTION | L X H |
|--------|-----------------------------------|--------------|
| BL112W | "Exit", White Background | 12" x 8" |
| BL112 | "Exit", Red Background | 12" x 8" |
| BL126 | "Not An Exit" | 10" x 9" |
| BL117 | "In Case Of Fire...Use Stairways" | 5 1/2" x 7" |
| BL137 | "This Door To Remain Unlocked..." | 23" x 1 7/8" |
| BL187 | "This Door To Remain Unlocked..." | 12" x 6" |
| BL167 | "Fire Door - Keep Closed" | 12" x 6" |
| BL168 | "Emergency Exit Only" | 12" x 6" |
| BL169 | "Emergency Exit Only..." | 12" x 6" |
| BL133 | Directional Arrow | 4" Dia |
| BL113 | Directional Arrow | 8" x 5" |
| BL121 | Directional Arrow | 12" x 1 1/2" |

ALUMINUM SIGNS

| P/N | DESCRIPTION | L X H |
|------|-------------|----------|
| A112 | "Exit" | 12" x 8" |

RIGID PLASTIC SIGNS

| P/N | DESCRIPTION | L X H |
|-------|-----------------------------------|-------------|
| RP112 | "Exit" | 12" x 8" |
| RP117 | "In Case Of Fire...Use Stairways" | 5 1/2" x 7" |

3-D RIGID PLASTIC ANGLE SIGNS

| P/N | DESCRIPTION | L X H |
|--------|-------------|----------|
| PTD112 | "Exit" | 12" x 8" |



FIRE HOSE SIGNS

VINYL SIGNS

| P/N | DESCRIPTION | L X H |
|-------|-------------------|----------|
| BL111 | "Fire Hose" | 12" x 4" |
| BL118 | "Fire Hose" Arrow | 8" x 12" |
| BL125 | "Fire Hose" Arrow | 4" x 18" |

PLASTIC 90° ANGLE SIGNS

| P/N | DESCRIPTION | L X H |
|--------|-------------------|----------|
| PWM125 | "Fire Hose" Arrow | 4" x 18" |



FIRE ALARM SIGNS

VINYL SIGNS

| P/N | DESCRIPTION | L X H |
|-------|----------------------------------|----------|
| BL119 | "Fire Alarm" Arrow | 8" x 12" |
| BL185 | "Fire Alarm Pull Station Inside" | 4" x 4" |

3-D RIGID PLASTIC ANGLE SIGNS

| P/N | DESCRIPTION | L X H |
|--------|--------------------|----------|
| PTD156 | "Fire Alarm" Arrow | 4" x 12" |



DANGER SIGNS

RIGID PLASTIC SIGNS

| P/N | DESCRIPTION | L X H |
|-------|----------------------------|----------|
| RP139 | "Danger High Voltage" | 10" x 8" |
| RP140 | "Danger No Smoking" | 10" x 8" |
| RP145 | "Danger Safety Glasses" | 10" x 8" |
| RP146 | "Danger Flammable Liquids" | 10" x 8" |
| RP147 | "Danger Authorized ..." | 10" x 8" |
| RP148 | "Danger Construction" | 10" x 8" |
| RP150 | "Danger Flammable" | 10" x 8" |
| RP151 | "Danger Hard Hat Area" | 10" x 8" |
| RP152 | "Danger Keep Out" | 10" x 8" |
| RP153 | "Danger Do Not Enter" | 10" x 8" |
| RP154 | "Danger Ear Protection" | 10" x 8" |



SAFETY TRAINING POSTERS

SAFETY TRAINING POSTERS provide concise, easy-to-understand explanations of key safety topics and their specific issues. All posters are laminated on both sides for extra durability.

| P/N | DESCRIPTION | L X H | EACH |
|----------|----------------------|-----------|------|
| FEPOSTER | "Fire Extinguisher" | 24" x 18" | |
| FAPOSTER | "First Aid Training" | 24" x 18" | |





MISCELLANEOUS SIGNS

The **HEIGHT INDICATOR** mounts next to door frames to help law enforcement determine a person's height. Durable vinyl exceeds Reflectivity 3 requirements and is adhesive-backed for easy installation. Tape is 1 1/2" x 3' and measures from 4' to 7'.

P/N DESCRIPTION
103650BY Height Indicator



VINYL SIGNS

| P/N | DESCRIPTION | L X H |
|-------|----------------------|--------------|
| BL170 | "Fire Blanket" Arrow | 4" x 18" |
| BL124 | Hose Rack Operation | 13" x 2 3/4" |

| P/N | DESCRIPTION | L X H |
|-------|---------------------------|----------|
| BL144 | "First Aid Station" Arrow | 8" x 12" |

| P/N | DESCRIPTION | L X H |
|-------|------------------------|---------|
| BL157 | "First Aid Kit Inside" | 4" x 4" |



RIGID PLASTIC SIGNS

| P/N | DESCRIPTION | L X H |
|-------|---------------------------------|----------|
| RP176 | "Emergency Eye Wash..." | 8" x 10" |
| RP120 | "In Case of Emergency Dial 911" | 8" x 10" |
| RP144 | "First Aid" | 8" x 10" |
| RP257 | "For Use On Combustible ..." | 7" x 10" |

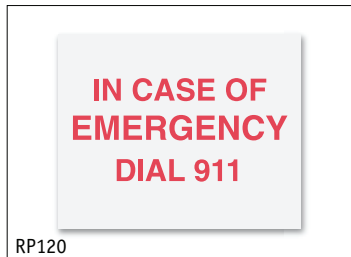

3-D RIGID PLASTIC ANGLE SIGNS

| P/N | DESCRIPTION | L X H |
|--------|-------------------------|-----------|
| PTD261 | AED Stand-Out | 5" x 6" |
| PTD176 | "Emergency Eye Wash..." | 18" x 10" |



GLOW-IN-THE-DARK SIGNS

GLOW-IN-THE-DARK SELF-ADHESIVE VINYL SIGNS

will glow for up to eight hours, remaining very visible in normal lighting. Cycling from daylight to darkness will not wear out signs.

| P/N | DESCRIPTION | L X H |
|------|---------------------------|-------------|
| G108 | "Fire Extinguisher" Arrow | 4" x 12" |
| G109 | "Fire Extinguisher" Arrow | 4" x 18" |
| G112 | "Exit" | 12" x 8" |
| G113 | Directional Arrow | 8" x 5" |
| G126 | "No Exit" | 5" x 5 1/4" |
| G186 | "Fire Extinguisher" | 6" x 1" |
| G261 | AED Sign | 6" x 8" |

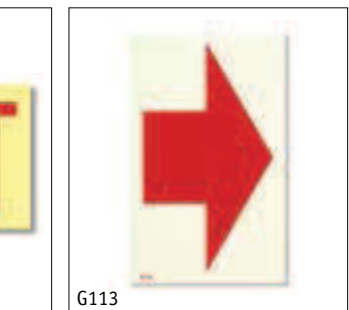

SYSTEM SIGNS

ALUMINUM SIGNS (ADHESIVE-BACKED)

| P/N | DESCRIPTION | L X H |
|-------|--------------------------|---------|
| A106 | "Caution..." | 5" x 2" |
| A106S | Spanish "Caution..." | 5" x 2" |
| A272 | "Remote Pull Station..." | 5" x 3" |
| A273 | "Fire System..." | 5" x 3" |
| A276 | "Fryer" | 4" x 2" |
| A277 | "Griddle" | 4" x 2" |
| A278 | "Broiler" | 4" x 2" |
| A281 | "Hood #1" | 4" x 2" |
| A282 | "Hood #2" | 4" x 2" |
| A283 | "Hood #3" | 4" x 2" |
| A284 | "Hood #4" | 4" x 2" |



A106



A272



A273



A276



A221



A223

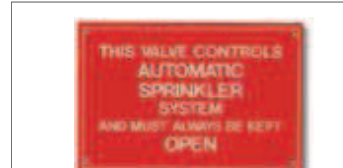

A142



A226



A160



A232

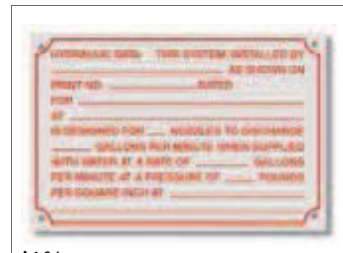

A164



A165



RP251

SPRINKLER SIGNS

SPRINKLER IDENTIFICATION SIGNS are made of aluminum, painted white, and printed with fade-resistant red ink. Each sign has predrilled mounting holes for easy installation.

| P/N | DESCRIPTION | L X H |
|-------|-----------------------------|-------------|
| A142 | "...Automatic Sprinkler..." | 6" x 4" |
| A143 | "Control Valve" | 6" x 2" |
| A160 | "Inspection Test" | 6" x 2" |
| A161 | "Main Drain" | 6" x 2" |
| A162 | "Sprinkler Control" | 6" x 2" |
| A163 | "Alarm Test" | 6" x 2" |
| A164 | "Hydraulic Data..." | 6" x 4" |
| A165 | "Sprinkler Fire-Alarm..." | 7 3/4" x 6" |
| A221♦ | "Air Control" | 6" x 2" |
| A222♦ | "Air Line" | 6" x 2" |
| A223♦ | "Alarm Line" | 6" x 2" |
| A224♦ | "Anti-Freeze System" | 6" x 2" |
| A225♦ | "Auxiliary Drain" | 6" x 2" |
| A226♦ | "This Valve Controls..." | 9" x 7" |
| A227♦ | "Drain" | 6" x 2" |
| A228♦ | "Drain Valve" | 6" x 2" |
| A229♦ | "Dry Standpipe" | 6" x 2" |
| A230♦ | "Entire System" | 6" x 2" |
| A232♦ | "Hydraulic System..." | 5" x 7" |
| A233♦ | "Main Control" | 6" x 2" |
| A234♦ | "Normally Closed" | 6" x 2" |
| A235♦ | "Normally Open" | 6" x 2" |
| A236♦ | "Open Sprinkler Control" | 6" x 2" |
| A237♦ | "Open Sprinkler Drain" | 6" x 2" |
| A238♦ | "Sprinkler Valve Room" | 6" x 2" |
| A239♦ | "Test & Drain" | 6" x 2" |
| A240♦ | "Test Valve" | 6" x 2" |
| A241♦ | "Water Motor Line" | 6" x 2" |
| A242♦ | "Wet Standpipe" | 6" x 2" |
| A243♦ | "Fire Sprinkler Valve" | 6" x 2" |

♦ Plastic coated

SPRINKLER ALARM SIGNS are made of plastic, painted red, and printed with fade-resistant white ink. Each circular sign has a predrilled mounting hole for easy installation over alarm bell.

| P/N | DESCRIPTION | DIA | EACH |
|-------|---------------------------|-----|------|
| RP251 | "Sprinkler Fire Alarm..." | 7" | |

These quality made **FDC SIGNS** help firefighters find water sources quickly. Signs are made of aluminum with predrilled holes for easy mounting.

| P/N | DESCRIPTION | L X H | EACH |
|-------|------------------------------|-----------|------|
| A244 | "Fire Department Connection" | 4" x 6" | |
| A245 | "FDC" w/ Arrow, 4" Letters | 12" x 10" | |
| A246 | "FDC", 6" Letters | 10" x 14" | |
| RA246 | "FDC", 6" Reflective Letters | 7" x 14" | |



A245



A246



RA246





EXAMPLE #1

THIS DOOR TO REMAIN UNLOCKED
WHEN THE BUILDING IS OCCUPIED

EXAMPLE #2

FRYER #1

EXAMPLE #3



EXAMPLE #4

SPRINKLER
CONTROL

EXAMPLE #5

CUSTOM ENGRAVED SIGNS

Two exciting options available—**PLASTIC WITH PRE-PUNCHED HOLES** or **PLASTIC WITH ADHESIVE BACK**.

- Custom made to your specifications—up to 432 sq. in.
- Seven different color schemes available.
- Comes complete with pre-punched corner holes or adhesive backs.
- Service your non-traditional sign needs with our custom signs up to (24" x 18").

EXAMPLES:

PLASTIC WITH PRE-PUNCHED HOLES



RED ON WHITE

PLASTIC WITH ADHESIVE BACK

System Serviced in Accordance with
NFPA17 or 17A and 96 by
ABC Fire Systems
(555) 555-5555

RED ON WHITE



BLACK ON YELLOW





CORPORATE HEADQUARTERS
 P.O. Box 481908
 Charlotte, NC 28269
 www.brooksequipment.com

TELEPHONE
 800.826.3473 / 704.596.9438
FAX
 800.433.9265
EMAIL
 sales@brooksequipment.com

CUSTOM ENGRAVED SIGNS EASY ORDER FORM

ORDERED BY

Company Name _____
 Account # _____
 Purchase Order _____
 Ordered By _____
 Phone _____ Fax _____

SHIP TO

Name _____
 Address _____
 Address _____
 City _____ State _____ Zip _____

DIRECTIONS

1 Check (✓) the orientation you want.

Portrait
 Landscape

2 What dimensions do you want?

_____ "H _____ "W
Maximum Sign Size: 18"H x 24"W
Minimum Size: 1"H x 2"W

3 Check (✓) the color you want.

RED ON WHITE (RW) **WHITE ON RED (WR)** **BLACK ON YELLOW (BKY)**
 WHITE ON BLUE (WB) **WHITE ON GREEN (WG)** **BLACK ON WHITE (BKW)**
 WHITE ON BLACK (WBK)

4 What do you want your sign to say?

If you have a special design or layout, draw it in the box.
Not a designer? Let us do it for you at no extra charge! Call your Account Rep for more information. (High resolution image required).

5 Check (✓) the type of mounting you want.

ADHESIVE BACKING
 CORNER HOLES

6 Add color code to part number(s) and insert quantities.

| CUSTOM ENGRAVED SIGNS WITH PRE-PUNCHED CORNER HOLES | | | | | |
|---|--------------------------------------|-----|------|-----|-----|
| P/N | DESCRIPTION | QTY | EACH | 10+ | 25+ |
| CS15_____ | Custom Engraved Sign up to 15 sq in | | | | |
| CS30_____ | Custom Engraved Sign up to 30 sq in | | | | |
| CS96_____ | Custom Engraved Sign up to 96 sq in | | | | |
| CS144_____ | Custom Engraved Sign up to 144 sq in | | | | |
| CS228_____ | Custom Engraved Sign up to 228 sq in | | | | |
| CS432_____ | Custom Engraved Sign up to 432 sq in | | | | |

| CUSTOM ENGRAVED SIGNS WITH FOAM ADHESIVE BACKING | | | | | |
|--|--------------------------------------|-----|------|-----|-----|
| P/N | DESCRIPTION | QTY | EACH | 10+ | 25+ |
| CS15_____A | Custom Engraved Sign up to 15 sq in | | | | |
| CS30_____A | Custom Engraved Sign up to 30 sq in | | | | |
| CS96_____A | Custom Engraved Sign up to 96 sq in | | | | |
| CS144_____A | Custom Engraved Sign up to 144 sq in | | | | |
| CS228_____A | Custom Engraved Sign up to 228 sq in | | | | |
| CS432_____A | Custom Engraved Sign up to 432 sq in | | | | |

PHOTOCOPY THIS FORM AND FAX TO 800.433.9265 OR VISIT WWW.BROOKSEQUIPMENT.COM

2014 © BROOKS EQUIPMENT COMPANY, LLC





FLORIDA TRUSS SIGNS, from **Brooks**, are made of engineer-grade prismatic material and available in .040 aluminum with radius corners and four mounting holes or vinyl peel and stick. Measuring 9" x 9" with the compliant 8" x 8" Maltese symbol, these signs are designed to comply with the requirements of Rule 69A-60.0081 of the Florida Fire Prevention Code. This rule requires that any structure that uses light-frame truss-type construction be marked with an approved symbol.

| P/N | DESCRIPTION |
|-------|----------------------------|
| AMR | Aluminum "R" (Roof) |
| AMRF | Aluminum "RF" (Roof/Floor) |
| AMF | Aluminum "F" (Floor) |
| BLMR | Vinyl "R" (Roof) |
| BLMRF | Vinyl "RF" (Roof/Floor) |
| BLMF | Vinyl "F" (Floor) |

BLMRF



BLMR



AMF



NUMBER KIT

Self-adhesive **NUMBER KIT** includes 25 each of numbers 0-9, measuring 1"H x 5/8"W with a 1/8" border (top and bottom). Comes in a sturdy 10-compartment plastic storage box. Order numbers individually too.

| P/N | DESCRIPTION | EACH |
|-------|-------------------------------------|------|
| BLKIT | Self-Adhesive Vinyl Number Kit | |
| BL__ | Individual Numbers, 0-9 | |
| | <i>Add Number to Blank to Order</i> | |

BLKIT



BL101



BL102



BL103



BL101N



BL102N



BL103N

EXTINGUISHER OPERATING LABELS

Self-adhesive, vinyl **FIRE CLASSIFICATION LABELS**.

| P/N | DESCRIPTION | L X H |
|--------|--------------------------|-----------------|
| BL101 | "Use On All Fires - ABC" | 4 1/2" x 1 3/4" |
| BL102 | "Use Only On - BC" | 4 1/2" x 1 3/4" |
| BL103 | "Use Only On - A" | 4 1/2" x 1 3/4" |
| BL101N | "ABC" Pictorial | 4 1/2" x 1 3/4" |
| BL102N | "BC" Pictorial | 3" x 1 3/4" |
| BL103N | "A" Pictorial | 4 1/2" x 1 3/4" |

BL122



Self-adhesive vinyl **PICTORIAL OPERATING LABELS**.

| P/N | DESCRIPTION | L X H |
|-------|--------------------------|-----------------|
| BL122 | Extinguisher Instruction | 5 1/2" x 2 1/2" |

BL200



Self-adhesive vinyl **PICTORIAL OPERATING LABELS** for ABC and BC fire extinguishers.

| P/N | DESCRIPTION | L X H |
|-------|--|-------------|
| BL200 | ABC Extinguisher w/ Hose Instruction | 3" x 5 1/4" |
| BL201 | ABC Extinguisher w/ Nozzle Instruction | 3" x 5 1/4" |
| BL202 | BC Extinguisher w/ Hose Instruction | 3" x 5 1/4" |
| BL203 | BC Extinguisher w/ Nozzle Instruction | 3" x 5 1/4" |



Self-adhesive vinyl **PICTORIAL OPERATING LABELS** for water and CO₂ fire extinguishers.

| P/N | DESCRIPTION | L X H |
|-------|--|-------------|
| BL204 | Water Extinguisher Instruction | 3" x 5 1/4" |
| BL206 | CO ₂ Extinguisher Instruction | 3" x 5 1/4" |



Self-adhesive vinyl **PICTORIAL OPERATING LABELS** for cartridge-operated ABC and BC fire extinguishers.

| P/N | DESCRIPTION | L X H |
|-------|--|-------------|
| BL207 | ABC Cartridge Extinguisher Instruction | 3" x 5 1/4" |
| BL208 | BC Cartridge Extinguisher Instruction | 3" x 5 1/4" |



Self-adhesive vinyl **PICTORIAL OPERATING LABELS** for CO₂ fire extinguishers.

| P/N | DESCRIPTION | L X H |
|-------|---|-------------|
| BL209 | 5 lb CO ₂ Extinguisher Instruction | 5" x 5 1/2" |
| BL210 | Larger CO ₂ Extinguisher Instruction | 5" x 5 1/2" |

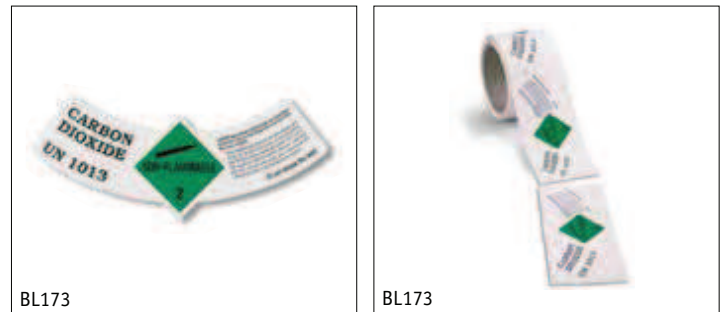

DOT LABELS

DEPARTMENT OF TRANSPORTATION COMPRESSED GAS LABELS, per DOT 49CFR, section 172.400A. Self-adhesive heavy-duty material with tough fade-resistant inks that will not come off with normal cleaning compounds.

| P/N | DESCRIPTION | L X H |
|-------|--------------------------|-----------------|
| BL173 | "Carbon Dioxide UN 1013" | 5 7/8" x 2 1/4" |

DEPARTMENT OF TRANSPORTATION LABELS

| P/N | DESCRIPTION | L X H |
|-------|---------------------------------|-----------------|
| BL177 | "Nitrogen Compressed UN 1066" | 5 3/4" x 2 1/4" |
| BL178 | "Halon 1211 & Nitrogen UN 1956" | 5 3/4" x 2 1/4" |



DEPARTMENT OF TRANSPORTATION LABELS

| P/N | DESCRIPTION | L X H |
|-------|---------------------------------|-----------------|
| BL179 | "Halon 1301 & Nitrogen UN 1956" | 5 7/8" x 2 1/4" |
| BL180 | "Compressed Air UN 1002" | 5 7/8" x 2 1/4" |



DEPARTMENT OF TRANSPORTATION LABELS

| P/N | DESCRIPTION | L X H |
|-------|----------------------------|-----------------|
| BL181 | "Oxygen UN 1072" | 5 3/4" x 2 1/4" |
| BL184 | "Carbon Dioxide UN 1013" | 3 3/8" x 2" |
| BL191 | "Halotron & Argon UN 1956" | 5 3/4" x 2 1/4" |
| BL192 | "FE36 & Nitrogen UN 1956" | 5 3/4" x 2 1/4" |





BL171



BL188

"NON-FLAMMABLE GAS" DOT SHIPPING LABELS

(paper) are sold in rolls of 500.

| P/N | DESCRIPTION | L X H | EACH |
|-------|---------------------|---------|------|
| BL171 | "Non-Flammable Gas" | 4" x 4" | |

DEPARTMENT OF TRANSPORTATION LABELS

| P/N | DESCRIPTION | L X H |
|-------|-------------------------------|--------------------------------------|
| BL188 | "Nitrogen Compressed UN 1066" | 3 ³ / ₈ " x 2" |



RS301

NFPA HAZARD IDENTIFICATION DIAMONDS come in two sizes, 10" and 16" square polystyrene. Designed to help meet hazcom/NFPA requirements with color coding to indicate fire, health, instability (reactivity), and special hazards. Also available are 3" (for 10" sign) and 6" (for 16" sign) black numeral/symbol kits. Kit includes three each of numerals 0, 1, 2, 3, 4, and one each of symbols for Oxidizer, Use No Water, Corrosive, and Radioactive. Minimum size of numerals and symbols must be 3" for legibility at 100' and 6" for legibility at 300'.

| P/N | DESCRIPTION | EACH |
|-------|-------------------------------------|------|
| RS301 | NFPA 10" Hazard Identification Sign | |
| RS302 | NFPA 16" Hazard Identification Sign | |
| BLK3 | 3" Numeral/Symbol Kit | |
| BLK6 | 6" Numeral/Symbol Kit | |



SSPHMCL1



SSPHMCL1

CUSTOM HAZMAT LABELS

Custom **HAZARDOUS MATERIAL COMMUNICATION LABELS** meet NFPA 10 requirements. Vinyl labels are custom imprinted with your company name, address, and phone number. Minimum of 100 each per copy. \$35 minimum order.

NOTE: Do not install on front of extinguisher, per NFPA 10.

| P/N | DESCRIPTION | L X H |
|----------|------------------------|---|
| SSPHMCL1 | ABC HazMat | 2 ³ / ₄ " x 2 ¹ / ₂ " |
| SSPHMCL2 | BC HazMat | 2 ³ / ₄ " x 2 ¹ / ₂ " |
| SSPHMCL3 | CO ₂ HazMat | 2 ³ / ₄ " x 2 ¹ / ₂ " |
| SSPHMCL4 | Halon HazMat | 2 ³ / ₄ " x 2 ¹ / ₂ " |
| SSPHMCL5 | Water HazMat | 2 ³ / ₄ " x 2 ¹ / ₂ " |
| SSPHMCL9 | Custom HazMat | 2 ³ / ₄ " x 2 ¹ / ₂ " |

Custom-imprinted metallic **CONDUCTIVITY TEST LABELS** have a single line imprint area. Two-roll minimum. 300 per roll.

| P/N | DESCRIPTION | L X H | EACH |
|--------|--|--------------------------------------|------|
| SSPCTL | Custom Conductivity Test | 3" x 3 ³ / ₄ " | |
| CTLBK | Blank Conductivity Test (No Minimum Order) | 3" x 3 ³ / ₄ " | |

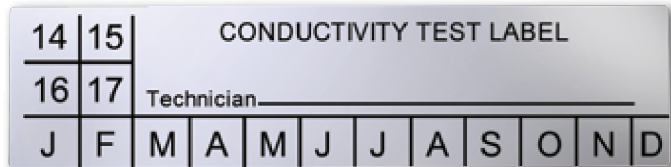

SSPCTL



CUSTOM HYDROTEST/6-YEAR LABELS

Choices—just one of many benefits of ordering from **Brooks**. **HYDROTEST** and **6-YEAR MAINTENANCE LABELS** are a necessary reminder to keep your customer's equipment maintenance and inspections up to date. And the benefit is, we'll custom imprint these labels with your company name, address, and phone number so your customer knows who to call. Plus you choose the material—white or blue vinyl or silver metallic that shows "Void" when removed—as recommended in NFPA 10. Minimum order is 1,000 for vinyl and 500 for metallic labels. Sold and priced per 100. Delivery is four to six weeks.

| P/N | DESCRIPTION | L X H | EACH |
|--------|--|-----------------|------|
| SSPVHT | Low-Pressure Hydrostatic Test, White Vinyl | 3 1/2" x 2 1/4" | |
| SSPV6H | 6-Year Standard Hydrotest, White Vinyl | 3 1/2" x 2 1/4" | |
| SSPVCA | California Hydrotest, White Vinyl | 3 1/4" x 2 1/4" | |
| SSPBL6 | 6-Year Maintenance, Blue Vinyl | 3 1/2" x 2 1/4" | |

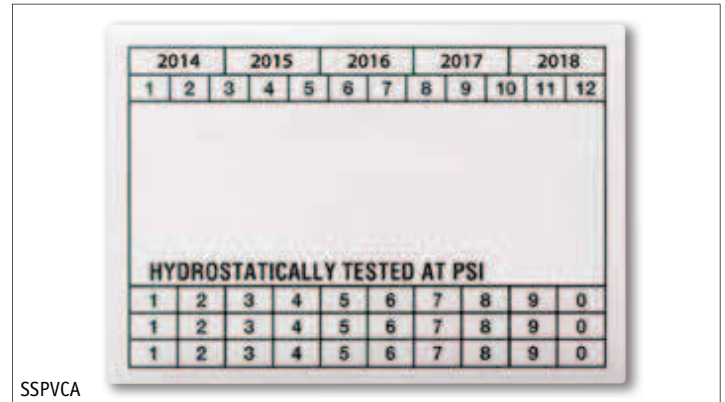

SSPVCA



SSPVHT



SSPV6H

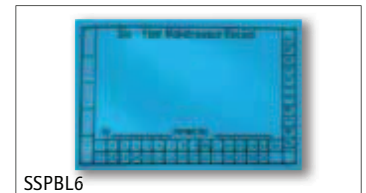

SSPBL6

Custom **HYDROTEST** and **6-YEAR MAINTENANCE METALIZED LABELS**.

| P/N | DESCRIPTION | L X H | EACH |
|----------|--|-----------------|------|
| SSPLPHTL | Low-Pressure Hydrostatic Test, Silver Metallic | 3 1/2" x 2 1/4" | |
| SSPHTLCA | California Hydrotest | 3 1/4" x 2 1/4" | |
| SSP6YR | 6-Year Maintenance | 3 1/2" x 2 1/4" | |
| SSP6HTL | 6-Year Standard Hydrotest | 3 1/2" x 2 1/4" | |

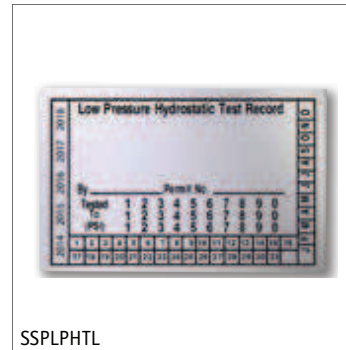

SSPLPHTL



SSPHTLCA

BLANK HYDROTEST/6-YEAR LABELS are silver "Void" metalized material. Stamp your own name (with permanent ink). 250 per roll.

| P/N | DESCRIPTION | L X H | EACH |
|--------|---|-----------------|------|
| 6HTLBK | 6-Year Blank Hydrotest, Silver Metallic | 3 1/2" x 2 1/4" | |



SSP6YR



SSP6HTL

COMPOSITE CYLINDER TEST LABELS for recording test information on composite cylinders, per DOT 49CFR, section 180.213. Instructions provided.

| P/N | DESCRIPTION | L X H | EACH |
|-------|---------------------------------|-------------|------|
| CRL50 | Composite Retest Labels, Pkg/50 | 2" x 1 1/4" | |



CRL50



5ME

FIVE-MINUTE EPOXY for applying over the **Composite Test Labels**.

| P/N | DESCRIPTION | EACH |
|-----|----------------------|------|
| 5ME | 5-Minute Epoxy, 1 oz | |





CUSTOM SERVICE TAGS

Custom-imprinted extinguisher **SERVICE TAGS** are printed on both sides on coated 13-pt stock with reinforced eyelets. Metal eyelets and/or wire optional. Deadline—final proof due every 10th and 25th of each month with delivery in six to eight weeks. Years are changed automatically every October. Colors available: Yellow (Y), *Orange (O), Blue (B), Green (G), Red (R), **Lilac (L), and White (W). Call Sales for pricing on large orders, special designs and our custom stocking program.

NOTE: It is the customer's responsibility to be sure the tag design meets all local and state regulations. SSPRUSH35 not available for Tyvek® tags.

* Available for SSPST only!

** Available for SSPST, SSPCA, and SSPNF.



| P/N | DESCRIPTION | EACH |
|------------|--|------|
| SSPPL | Plate Charge (New & Revised Orders Only) | |
| SSPSU | Set-Up Charge (For Each Order) | |
| SSPME | Metal Eyelets Add-On | |
| SSPWIRE | Wire Attachment Add-On | |
| SSP2CO | Additional Ink Add-On | |
| SSPTVK | Tyvek Add-On, White Only (5,000 min.) | |
| SSPTVKWIRE | Tyvek Wire Attachment Add-On | |
| SSPFLU | Fluorescent Add-On (No Rush Delivery) | |
| SSPRUSH | Rush Delivery Charge, 2-3 Week Print-Time | |
| SSPRUSH35 | Rush Delivery Charge, 3-5 Day Print-Time (Max 10,000 Tags) | |

Custom-imprinted **SELF-INKING STAMP KIT** comes complete with everything you need—stamp, ink, and dry cartridge. Easily stamps standard and coated cardstock. Stamp also features clear positioning window for accurate positioning and replaceable ink cartridges. **STAMP1** offers 2,500 impressions and **STAMP2** 8,000 impressions per bottle of ink. Signed proof must be received before order is processed. Allow one week for delivery.



| P/N | DESCRIPTION | EACH |
|-----------------|--------------------------------|------|
| → STAMP1HOUSING | Replacement Housing for STAMP1 | |
| → STAMP2HOUSING | Replacement Housing for STAMP2 | |
| → DIC1 | Dry Ink Cartridge for STAMP1 | |
| → DIC2 | Dry Ink Cartridge for STAMP2 | |
| → BTI | Black Textile Ink, 2 oz | |
| → CUSTOMSTAMP1 | Custom Stamp, 1 1/2" x 3" | |
| → CUSTOMSTAMP2 | Custom Stamp, 3/4" x 1 7/8" | |

Custom-imprinted **STANDARD SERVICE TAGS** have a minimum order of 2,000 tags. See above for additional options and color codes. Priced and sold per 1,000.

| P/N | DESCRIPTION | L X H |
|------------|-----------------------|-----------------|
| SSPST_ | Custom Service Tags | 2 3/8" x 5 1/4" |
| → STSTAMP2 | Stamp for Service Tag | 3/4" x 1 7/8" |

Custom-imprinted **SERVICE TAGS** have a minimum order of 2,000 tags. Tags meet state regulations as of catalog printing. See above for additional options and color codes. Priced and sold per 1,000.

NOTE: Red not permitted in Texas!

| P/N | DESCRIPTION | L X H |
|---------------|--------------------------|-----------------|
| SSPFL_ | Custom Florida | 2 3/8" x 5 1/4" |
| → FLSTAMP2 | Stamp for Florida Tag | 3/4" x 1 7/8" |
| SSPTX_ | Custom Texas | 2 3/8" x 5 1/4" |
| → TXSTAMP1 | Stamp for Texas Tag | 1 1/2" x 3" |
| SSPGA | Custom Georgia, Yellow | 3" x 5 1/2" |
| → GASTAMP2 | Stamp for Georgia Tag | 3/4" x 1 7/8" |
| SSPGAB | Custom Georgia, Lt. Blue | 3" x 5 1/2" |
| → GABSTAMP2 | Stamp for Georgia Tag | 3/4" x 1 7/8" |
| SSPLTAG | Custom Louisiana, Green | 2 3/8" x 5 1/4" |
| → LTAGSTAMP1 | Stamp for Louisiana Tag | 1 1/2" x 3" |
| SSPLTAGB | Custom Louisiana, Blue | 2 3/8" x 5 1/4" |
| → LTAGBSTAMP1 | Stamp for Louisiana Tag | 1 1/2" x 3" |

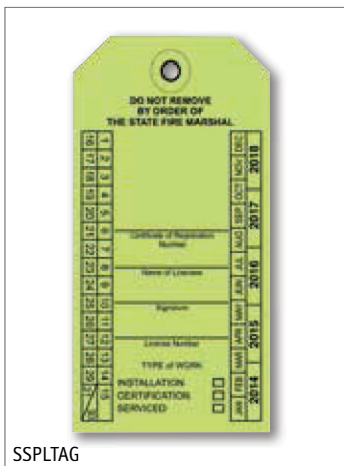

Custom-imprinted **ILLINOIS SERVICE TAGS** have a minimum order of 4,000 tags. Tags meet state requirements as of catalog printing. See page 162 for additional options. Green. Priced and sold per 1,000.

| P/N | DESCRIPTION | L X H |
|------------|-----------------------------------|---|
| SSPILG | Custom 2014 Illinois Service Tags | 2 ⁵ / ₈ " x 5 ¹ / ₄ " |
| → ILSTAMP2 | Stamp for Illinois Tag | 3/4" x 1 ⁷ / ₈ " |

Custom-imprinted **CALIFORNIA SERVICE TAGS** have a minimum order of 2,000 tags. Tags meet state regulations as of catalog printing. See page 162 for additional options and color codes. Priced and sold per 1,000.

NOTE: Red not permitted in California!

| P/N | DESCRIPTION | L X H |
|----------------------------------|------------------------------------|---|
| SSPCA_ | Custom California Tag | 2 ³ / ₈ " x 4 ³ / ₄ " |
| Add Color Code to Blank to Order | | |
| → CASTAMP2 | Stamp for California Tag | 3/4" x 1 ⁷ / ₈ " |
| SSPCAFSTAG | Custom CA Fixed Systems Tag, White | 2 ⁵ / ₈ " x 5 ¹ / ₄ " |
| → CAFTAGSTAMP1 | Stamp for California FS Tag | 1 ¹ / ₂ " x 3" |

Custom-imprinted **"N"-STYLE SERVICE TAG** has a minimum order of 2,000 tags. Tag is printed in black and red ink. See page 162 for additional options and color codes. Priced and sold per 1,000.

| P/N | DESCRIPTION | L X H |
|----------------------------------|------------------------------|---|
| SSPNF_ | Custom "N"-Style Service Tag | 2 ⁵ / ₈ " x 5 ¹ / ₄ " |
| Add Color Code to Blank to Order | | |
| → NFSTAMP2 | Stamp for "N"-Style Tag | 3/4" x 1 ⁷ / ₈ " |

BLANK SERVICE TAGS

BLANK SERVICE TAGS are priced per 100. All tags meet state regulations as of catalog printing.

| P/N | DESCRIPTION | L X H |
|------------------|-------------------------------|---|
| STAGBK | Blank Standard Tag, Yellow | 2 ⁷ / ₈ " x 5 ¹ / ₄ " |
| → STAGBKSTAMP1 | Stamp for Blank Standard Tag | 1 ¹ / ₂ " x 3" |
| GATAGBK | Blank Georgia Tag, Yellow | 3" x 5 ¹ / ₂ " |
| → GATAGBKSTAMP1 | Stamp for Blank Georgia Tag | 1 ¹ / ₂ " x 3" |
| GABTAGBK | Blank Georgia Tag, Lt. Blue | 3" x 5 ¹ / ₂ " |
| → GABTAGBKSTAMP1 | Stamp for Blank Georgia Tag | 1 ¹ / ₂ " x 3" |
| LGTAGBK | Blank Louisiana Tag, Green | 2 ⁷ / ₈ " x 5 ¹ / ₄ " |
| → LGTAGBKSTAMP1 | Stamp for Blank Louisiana Tag | 1 ¹ / ₂ " x 3" |
| XTAGBK | Blank Texas Tag, White | 2 ⁷ / ₈ " x 5 ¹ / ₄ " |
| → XTAGBKSTAMP1 | Stamp for Blank Texas Tag | 1 ¹ / ₂ " x 3" |
| ILTAGBK | Blank Illinois Tag, Lt. Green | 2 ⁷ / ₈ " x 5 ¹ / ₄ " |
| → ILTAGBKSTAMP1 | Stamp for Blank Illinois Tag | 1 ¹ / ₂ " x 3" |
| NFWBK | Blank "N"-Style Tag, White | 2 ⁵ / ₈ " x 5 ¹ / ₄ " |
| → NFWBKSTAMP1 | Stamp for Blank "N"-Style Tag | 1 ¹ / ₂ " x 3" |

CUSTOM SERVICE AND INSTALLATION LABELS

Custom, vinyl **SERVICE LABELS** can be printed with your custom design or our standard design. Imprinted with fade-resistant black ink on white vinyl. Sold in rolls of 1,000 each.

| P/N | DESCRIPTION | L X H |
|-------------|----------------------------------|---|
| SSPVSTAG | Custom Service Label | 2 ⁵ / ₈ " x 5 ¹ / ₄ " |
| SSPCSTAG | Custom Design Label | 2 ⁵ / ₈ " x 5 ¹ / ₄ " |
| SSPCACS | Custom CA Service Label | 2 ⁵ / ₈ " x 5 ¹ / ₄ " |
| SSPCASYS | Custom CA Mandated Systems Label | 2 ⁵ / ₈ " x 5 ¹ / ₄ " |
| SSPCANFPA25 | Custom CA NFPA Sprinkler Label | 2 ⁵ / ₈ " x 5 ¹ / ₄ " |
| SSPFLTAG | Custom FL Service Label | 2 ⁵ / ₈ " x 5 ¹ / ₄ " |

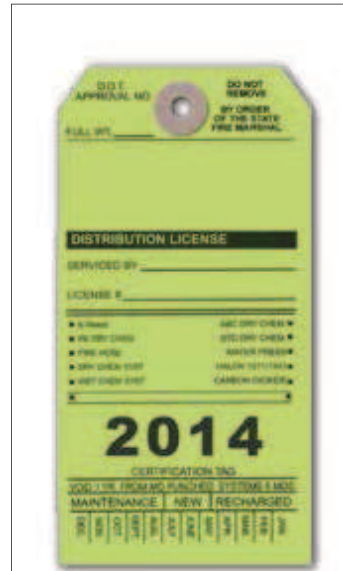

SSPILG

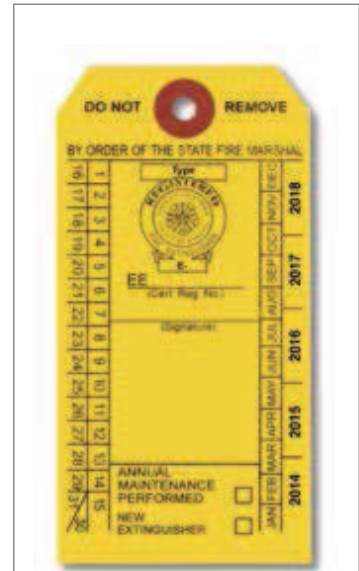

SSPCAY



SSPCAFSTAG

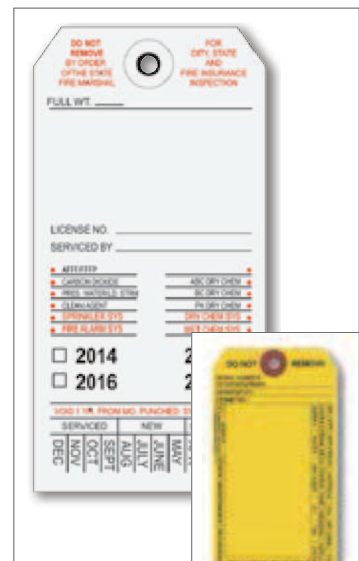

SSPNFW & NFWBK



STAGBK

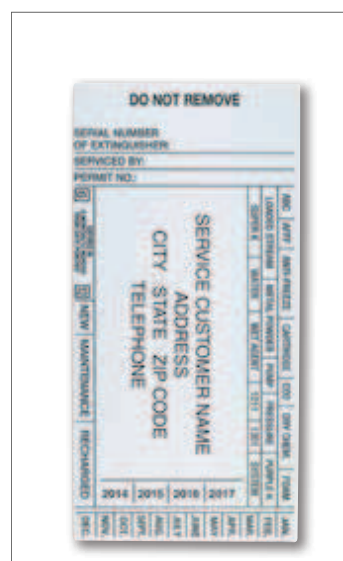

SSPVSTAG



SSPCASYS





Custom **"CALL FOR SERVICE" LABEL** with your company name and phone number. White polyvinyl with red/yellow border and black imprint. Use on extinguishers, hoods, first aid kits, hose stations, etc. Sold in rolls of 500 each.

| P/N | DESCRIPTION | L X H | EACH |
|--------|---------------------------|-------------|------|
| SSPFSL | Custom "Call for Service" | 3 1/4" x 2" | |

SSPFSL

SSPFSL

Imprinted vinyl **INSTALLATION LABEL** for automatic systems and alarm panels. Sold in rolls of 100 each.

| P/N | DESCRIPTION | L X H | EACH |
|---------|------------------------------|-----------------|------|
| LAIL100 | Louisiana Installation Label | 3 7/8" x 3 7/8" | |
| TXIL100 | Texas Installation Label | 5" x 4" | |
| OKIL100 | Oklahoma Installation Label | 5" x 4" | |



LAIL100

LAIL100

AGENT REPLACEMENT LABEL. Use to record agent replacement as required by NFPA 10, sections 7.4.2.3.1 (Foam), 7.4.2.2 (Wet Agent), and 7.4.3.11 (Wet Chemical). Same material as our continuity test labels (silver metallic), preprinted with four years on a roll of 300 labels.

| P/N | DESCRIPTION | L X H | EACH |
|--------|-------------------------|-----------|------|
| ARL300 | Agent Replacement Label | 3" x 3/4" | |



ARL300

VERIFICATION OF SERVICE COLLARS (CUSTOM AND BLANK)

VERIFICATION OF SERVICE COLLARS. Made of durable polymer material, collars are available in four different sizes. Each size is a different color for identification. Two smallest sizes have two years molded; larger ones have four.

NOTE: Collars read, "Verification of Service, YR ____-____" and "MN 1-12".

| P/N | DESCRIPTION | PKG QTY | ID | EACH |
|-----|-------------|---------|---------|------|
| SC1 | Green | 100 | 1 3/8" | |
| SC2 | Gray | 100 | 1 3/4" | |
| SC3 | Blue | 50 | 2 1/8" | |
| SC4 | Violet | 50 | 3 1/16" | |



SERVICE COLLARS



SC1

Custom-imprinted **VERIFICATION OF SERVICE COLLARS** comply with NFPA 10. Made of high-density polyethylene with clear polyester over lamination. Available in four sizes with your company name and phone number imprinted in durable colored ink on white background. Other custom imprint available (as required by state). Normal delivery is two to four weeks. \$35 minimum order.

NOTE: Collars approved for the State of Georgia.

| P/N | DESCRIPTION | PKG QTY | ID | EACH |
|--------|----------------|---------|---------|------|
| SSPCC1 | Custom, Green | 100 | 1 3/8" | |
| SSPCC2 | Custom, Gray | 100 | 1 3/4" | |
| SSPCC3 | Custom, Blue | 100 | 2 1/8" | |
| SSPCC4 | Custom, Violet | 100 | 3 1/16" | |

Custom-imprinted **CALIFORNIA VERIFICATION OF SERVICE COLLARS** meet California State requirements. Same specifications and order requirements as our custom-imprinted Verification of Service Collars (above).

NOTE: Company name and E# are required on CA collars.

| P/N | DESCRIPTION | PKG QTY | ID | EACH |
|----------|-------------------|---------|---------|------|
| SSPCCAL1 | Custom CA, Green | 100 | 1 3/8" | |
| SSPCCAL2 | Custom CA, Gray | 100 | 1 3/4" | |
| SSPCCAL3 | Custom CA, Blue | 100 | 2 1/8" | |
| SSPCCAL4 | Custom CA, Violet | 100 | 3 1/16" | |

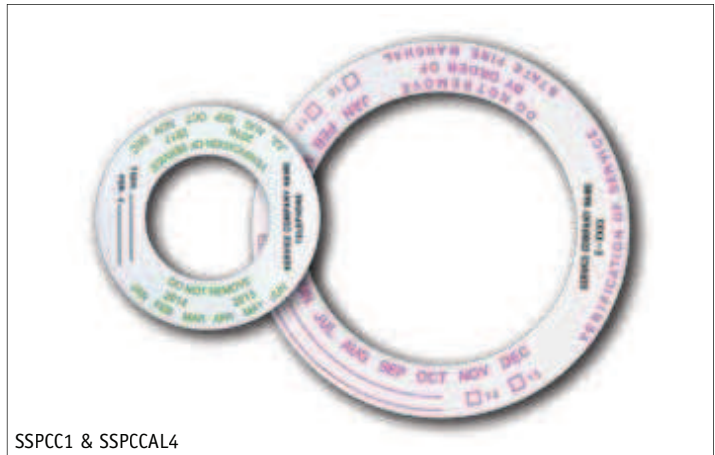

SSPCC1 & SSPCCAL4



MISCELLANEOUS TAGS

CUSTOMER REPAIR TAG allows you to document the work performed on each extinguisher and the total amount to be paid. Comes with a looped string for easy attachment around gauge. The bottom is perforated to give the customer their claim check. Sold in packages of 100.

| P/N | DESCRIPTION | L X H | EACH |
|-------|---------------------|-----------------|------|
| CRTAG | Customer Repair Tag | 3 1/8" x 5 1/2" | |

Blank **TEXAS IMPAIRED TAG** is designed for use with portable extinguishers and systems, per Texas Code. Red with black imprint. Sold in packages of 100.

| P/N | DESCRIPTION | L X H | EACH |
|---------|--------------------|-----------------|------|
| REDTXBK | Texas Impaired Tag | 2 3/8" x 5 1/4" | |

NON-COMPLIANCE TAG is for recording deficiencies in fire equipment. Two-part carbon form with paper front and heavy, red stock backing. **TNC50** meets State of Georgia code and **CANC50** meets State of California code. Sold in packages of 50.

| P/N | DESCRIPTION | L X H | EACH |
|--------|-------------------------------|-----------------|------|
| TNC50 | Non-Compliance Tag | 3 1/8" x 6 1/4" | |
| CANC50 | California Non-Compliance Tag | 3 1/8" x 6 1/4" | |

CONDEMNED TAG for extinguishers that need to be removed from service. Red, as required by many states. Sold individually.

| P/N | DESCRIPTION | L X H | EACH |
|-------|---------------|-----------------|------|
| ECTAG | Condemned Tag | 5 1/4" x 2 3/4" | |

Use this perforated **CYLINDER TAG** to indicate whether your cylinders are empty, in use, or full. Tags are white and come with a fiber patch and wires. Sold in packs of 50.

| P/N | DESCRIPTION | L X H | EACH |
|------|--------------|-----------------|------|
| 3PCT | Cylinder Tag | 2 3/8" x 5 1/4" | |

AED INSPECTION TAG is sold in packages of 100. White with red print.

| P/N | DESCRIPTION | L X H | EACH |
|----------|--------------------|-----------------|------|
| AEDTAGBK | AED Inspection Tag | 2 5/8" x 5 1/4" | |

Plastic three-year monthly **INSPECTION & RECHARGE TAG** record is designed for recording service and inspection dates, all on one tag. Printed in black and red ink on plastic stock. Back side is printed with twelve-month record (up to four years). Sold individually.

| P/N | DESCRIPTION | L X H | EACH |
|------|---------------------------|---------------|------|
| ITAG | Inspection & Recharge Tag | 2 15/16" x 5" | |



CRTAG



REDTXBK



TNC50



ECTAG



3PCT



AEDTAGBK



ITAG



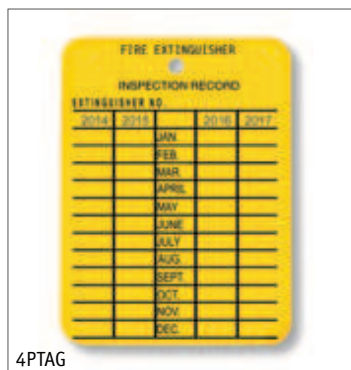

METAL 4-YEAR INSPECTION TAG is designed to record monthly inspections of fire extinguishers.

| P/N | DESCRIPTION | L X H | EACH |
|-----|-----------------------------|-------------|------|
| TAG | Metal 4-Year Inspection Tag | 2 1/4" x 3" | |

PLASTIC 4-YEAR INSPECTION TAG is made of strong 23 mil high-density yellow plastic. Tags will not break, tear, crack, or become brittle with age. Unaffected by moisture, oils, and grease too. Sold individually.

| P/N | DESCRIPTION | L X H | EACH |
|-------|-------------------------------|-------------|------|
| 4PTAG | Plastic 4-Year Inspection Tag | 2 1/4" x 3" | |

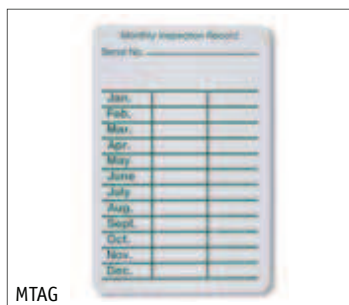

Peel-and-stick monthly **INSPECTION TAG** is printed with green ink on white label stock. Sold in rolls of 100.

| P/N | DESCRIPTION | L X H | EACH |
|------|----------------|---------|------|
| MTAG | Inspection Tag | 2" x 3" | |

PLASTIC INSPECTION TAG is for outside use. Will not tear, break, crack, or become brittle with age. Unaffected by moisture, oils, and grease too. Twelve-month record on yellow plastic. Sold individually.

| P/N | DESCRIPTION | L X H | EACH |
|------|------------------------|-----------------|------|
| PTAG | Plastic Inspection Tag | 2 1/2" x 4 1/8" | |



The **MONTHLY INSPECTION TAG**, printed on card stock, is ideal for indoor monthly fire equipment inspections by plant personnel. Sold in packages of 100.

| P/N | DESCRIPTION | L X H | EACH |
|-------|------------------------|-----------------|------|
| RT100 | Monthly Inspection Tag | 2 3/8" x 5 1/4" | |

FIRE HOSE INSPECTION/HYDROTEST TAGS are printed with red ink on white card stock. Sold individually.

| P/N | DESCRIPTION | L X H | EACH |
|-------|------------------------------------|-----------------|------|
| FHTAG | Fire Hose Inspection/Hydrotest Tag | 2 7/8" x 5 3/4" | |



TAG ACCESSORIES

TAG COVERS are perfect for keeping dust and water away from your tags.

NOTE: See Page 303 for "Zip Lock Report Holders".

| P/N | DESCRIPTION | H X W | EACH |
|--------|--|------------------|------|
| STC | Standard Tag Cover 2.5 mil Poly | 6 3/4" x 3 1/2" | |
| HSTC | Heavy-Duty Tag Cover 10 mil Frosty Matte Soft Vinyl | 6 1/2" x 3 1/8" | |
| TBZL2* | Resealable Tag Cover (Adhesive-Backed) 10 mil Satin | 6 3/4" x 3 5/16" | |
| TBZL3* | Resealable Tag Cover 10 mil Satin | 6 3/4" x 3 3/8" | |
| RFTC2* | Heavy-Duty Red Flap Tag Cover 10 mil Satin | 7" x 3 5/16" | |

*MUST BE PURCHASED IN QUANTITIES OF 50

TAG FASTENERS

| P/N | DESCRIPTION | EACH |
|--------|--------------------------------------|------|
| SAT | 5" Secur-A-Tach Tag Seal, Pkg/1,000 | |
| NS18 | 5 1/2" Nylon Tag Seal, Pkg/5,000 | |
| PS14 | 5 1/4" Polypropylene Seal, Pkg/5,000 | |
| WF | Galvanized Tag Wire, Pkg/1,000 | |
| TF1000 | Diamond Tag Fastener, Pkg/1,000 | |

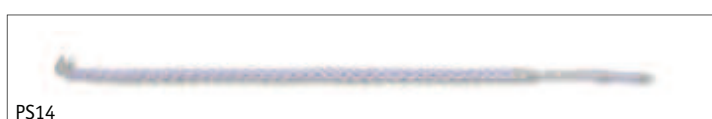

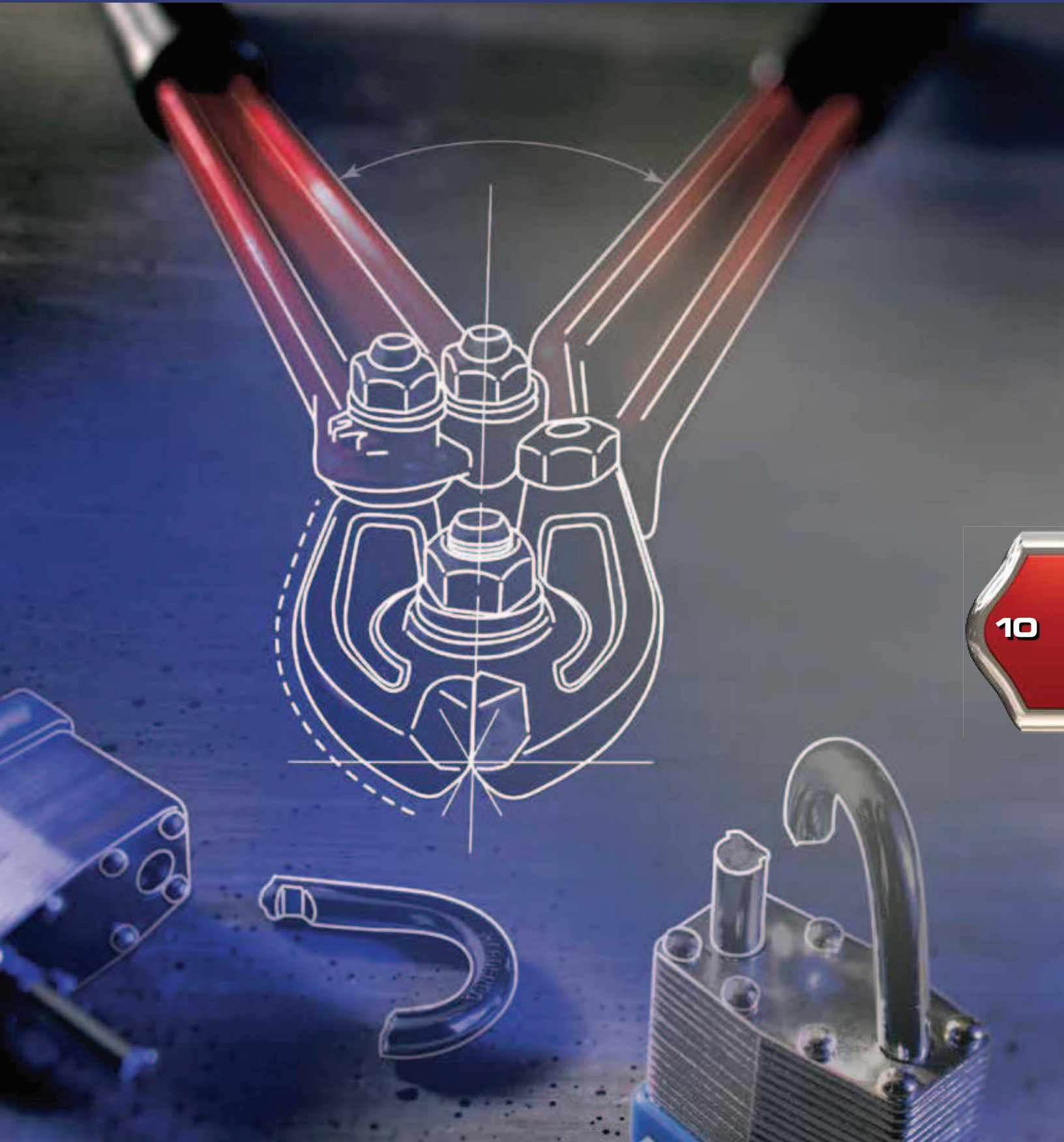

*One-Stop-Shop:
Optimize savings—fast.*



HOLE PUNCHES AND CHAIN REEL

HOLE PUNCHES make a 1/8" round hole and come with clipping receptacles. **HP1** is for light-duty punching of a single paper tag or label. **HP2** is a heavy-duty punch, recommended for more frequent punching of single paper tags and labels.

NOTE: For punching multiple paper, metal, and plastic tags, as well as molded service collars, etc., please use our **HP3** or **TP5R** punches.

| P/N | DESCRIPTION | EACH |
|-----|----------------------------------|--------------|
| HP1 | Light-Duty Hole Punch (1" Reach) | |
| HP2 | Standard Hole Punch (2" Reach) | |
| HPH | Hole Punch Holster | SEE PAGE 193 |



HEAVY-DUTY/INDUSTRIAL HOLE PUNCHES can punch more than one tag at a time. **HP3** has a 2" reach, clipping receptacle, and punches a 1/8" round hole. **TP5R** has a 1" reach and punches a 1/8" round hole. These are ideal for punching our **Verification of Service Collars**.

| P/N | DESCRIPTION | EACH |
|------|----------------------------------|------|
| HP3 | Industrial Hole Punch (2" Reach) | |
| TP5R | Heavy-Duty Hole Punch (1" Reach) | |



Drill a hole in the handle of the hole punch and attach to our **CHAIN REEL** for safekeeping. Also a great way to keep track of your keys and/or system service pins.

| P/N | DESCRIPTION | EACH |
|-----|-------------|------|
| KC1 | Chain Reel | |

RECHARGE CHEMICAL

UL CLASSIFIED UNIVERSAL DRY CHEMICAL in 50 lb pails for use in many manufacturers' fire extinguishers (per NFPA 10).

| P/N | DESCRIPTION | SEE PAGE 24 |
|----------|--------------------------------|-------------|
| 50ABCULC | UL Classified ABC Dry Chemical | |



UNIVERSAL RECHARGE DRY CHEMICAL in 50 lb pails.

| P/N | DESCRIPTION | SEE PAGE 24 |
|----------|--|-------------|
| 50BCPAIL | BC Dry Chemical, 50 lbs | |
| 50PKPAIL | Purple K Dry Chemical, 50 lbs | |
| 50DPAIL | Class D Dry Powder (Sodium Chloride), 50 lbs | |

→ **OEM DRY CHEMICAL Available on page 24.**

OEM LIQUID CHEMICAL CHARGES

| P/N | DESCRIPTION | SEE PAGE 24 |
|----------|--|-------------|
| AX506 | Amerex Antifreeze Charge for 2 1/2 gal Loaded Stream Extinguishers | |
| AX5302 | Amerex Recharge for AX260, Pkg/2 | |
| AX660 | Amerex Recharge for AX262, Pkg/2 | |
| AC100 | Badger 6lit Recharge for WC100, Pkg/2 | |
| AC250 | Badger 2 1/2 gal Recharge for WC250 | |
| A430182 | Ansul PRX Liquid for K-Guard & Piranha, 6lit (K01, K01-1) | |
| A423320 | Ansul PRX Liquid for K-Guard & Piranha, 5 gal (K01, K01-1) | |
| BK600872 | Buckeye 6lit Recharge | |



Just Shake To Activate!

FireTech's EZ FILL SIPHON is not only easy but fast—transferring up to 3½ gallons of liquid per minute. The 6' clear hose is durable, flexible, non-toxic, and has a copper nipple that's anti-static and anti-spark for safety. Use to transfer liquids, including fuels, oils, water, paint, and more. To operate, make sure the liquid to be transferred is higher than the empty container. Submerge the **EZ Fill Siphon** and shake it to start the transfer.

| P/N | DESCRIPTION | EACH |
|--------|----------------|------|
| EZFILL | EZ Fill Siphon | |



EZFILL



EZFILL In Use

FUNNELS, SCOOPS, AND AIR HOSE

These retracting **Brooks' AIR HOSE REELS** are long lasting, thanks to the top-quality materials that go into making them. The **AHR33** is constructed from impact-resistant polypropylene, plus there's 33' of ¼" polyurethane mesh hose. Includes a swivel bracket for wall or ceiling mounting. The **AHR49** is even tougher—made of steel that's covered in a corrosion-resistant powder coating for extra-long life. It comes with 49' of ⅜" rubber hose and includes a multi-position ratchet lock, tension adjustment, and a full-flow swivel that prevents leakage. A guide arm also cuts down on hose wear and tear, plus with nine adjustable positions the reel can be mounted on the ceiling, floor, or wall. 300 psi.

| P/N | DESCRIPTION | EACH |
|-------|-------------------------|------|
| AHR33 | Air Hose Reel, 33' Hose | |
| AHR49 | Air Hose Reel, 49' Hose | |

COILED AIR HOSE and ACCESSORIES are for blowing out valves, cleaning off work areas, etc. **CH** models are permanently coiled hoses, made from abrasion resistant nylon and fitted with brass fittings. **AHC** models feature flexible polyurethane hose with swivel brass fittings. Hoses come standard with ¼" NPT(M) fittings on both ends.

NOTE: Do not use for recharge line!

| P/N | DESCRIPTION | EACH |
|-------|----------------------|------|
| CH12 | Coiled Air Hose, 12' | |
| CH25 | Coiled Air Hose, 25' | |
| AHC12 | Air Hose, 12' | |
| AHC25 | Air Hose, 25' | |

Get the **BLOW GUN** set-up for blowing out valves, cleaning work areas, etc.

| P/N | DESCRIPTION | EACH |
|------|--------------------------------------|------|
| SBG1 | Safety Blow Gun | |
| AD31 | ¼" Quick Disconnect Recharge Adapter | |
| QDC | Quick Disconnect Coupler | |

FILLING FUNNELS are made of durable galvanized steel with two different heavy-duty mesh screens, properly sized and spaced. The screens eliminate clogging and jamming of the funnel. Available in three sizes.

| P/N | DESCRIPTION | H X DIA X OD TIP | EACH |
|-----|-------------------|------------------|------|
| FF1 | Small Funnel | 15" x 6" x ¾" | |
| FF2 | Large Funnel | 13" x 10" x 1⅛" | |
| FF3 | Large Neck Funnel | 10" x 10" x 2¼" | |



AHR49



AHR33



CH Hose



AD31



AHC12



SBG1



QDC



FF1



FF2



FF3





METAL FILLING SCOOPS for filling dry chemical fire extinguishers.

| P/N | DESCRIPTION | EACH |
|------|-----------------------|------|
| NAS1 | Aluminum Scoop, 24 oz | |
| NAS2 | Aluminum Scoop, 38 oz | |

Aluminum **PAIL OPENER** for opening dry chemical pails quickly and easily without harming lid.

| P/N | DESCRIPTION | EACH |
|-----|-------------|------|
| PL0 | Pail Opener | |



RECHARGE EQUIPMENT

Getz VACU-FILL SYSTEMS are available with 50, 100, and 150 lb-capacity hoppers. All feature single-valve control console, filling line, discharge assembly, discharge screen, and powder recovery lid. Systems operate on air or nitrogen at 60–80 psi, 1–2 cfm.

| P/N | DESCRIPTION | H X W X D | EACH |
|------------|--|-----------------|------|
| VF50 | 50 lb Dry Chemical Filling System | 25" x 13" x 15" | |
| VF100D | 100 lb Dry Chemical Filling System | 32" x 20" x 15" | |
| VF150D | 150 lb Dry Chemical Filling System | 38" x 20" x 15" | |
| 51221GZ | Fill Cone | | |
| | Fits Vacu-Fill & EZ20 Systems | | |
| 51222GZ | Wheeled Unit Fill Cone | | |
| 51318GZ | Overflow Filter | | |
| | Fits Vacu-Fill & EZ20 Systems | | |
| 51346GZ | Overflow Jar Gasket | | |
| | Fits Vacu-Fill & EZ20 Systems | | |
| 51348GZ | Vacuum Gauge, 30" Hg | | |
| 51436GZ | Overflow Jar | | |
| | Fits Vacu-Fill & EZ20 Systems | | |
| 58559GZ | Hopper Lid Filter, 100 & 150 lb | | |
| 58633GZ | Venturi 50, 100, & 150 lb | | |
| 58654GZ | Velcro/Gasket Lid Kit for 100 & 150 lb | | |
| 58839GZ | Hopper Lid Filter, 50 lb | | |
| 58900GZ | Maintenance Kit for VF100D & VF150D | | |
| 58901GZ | Maintenance Kit for VF50 | | |
| 59117GZ | Velcro/Gasket Lid Kit for 50 lb | | |
| DDP59439GZ | Hopper Bucket Attachment for Filling | | |



MAINTENANCE RECOMMENDATIONS:

1. Filters should be changed every 90 days or sooner.
2. Replace jar gaskets and lid filters every 12 months.
3. On/Off valves should be replaced every two years.
4. Replace hoses if they show signs of wear or burn marks.

The **MECHANICAL BENCH VISE** (with hand-wheel) is versatile, compact, and easy to operate. Made from aluminum, it's perfect for use in a shop or on location at a job site. Vise jaws have non-slip belting and rear jaw is adjustable.

| P/N | DESCRIPTION | L X H X W | EACH |
|------|-----------------------|---------------|------|
| MBVD | Mechanical Bench Vise | 13" x 7" x 4" | |



The **SuperKan RECOVERY SYSTEM** is a quick, inexpensive way to empty portable dry chemical extinguishers. Constructed from brushed aluminum in an environmentally friendly design. It's also portable with a three-tier screen system. Can holds up to 30 lbs of chemical.

| P/N | DESCRIPTION | EACH |
|---------|------------------------------|------|
| 59377GZ | SuperKan | |
| 53329GZ | Filter for SuperKan | |
| 56251GZ | Rubber Assembly for SuperKan | |
| 53354GZ | Foam Seal | |



Pre-Packaged For Your Ultimate Convenience

Take your shop on the road with the **Getz SERVICE TRUCK DELUXE PACKAGE**. Includes the **Getz VF50 Vacu-Fill** system, a nitrogen regulator, recharge line with quick coupling, recharge adapter kit, and a pail opener. 50 lb capacity.

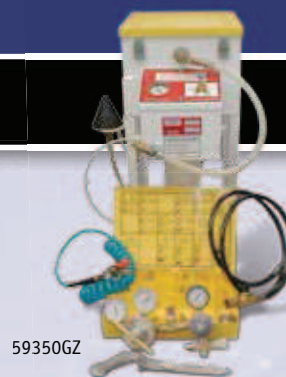

| P/N | DESCRIPTION | EACH |
|---------|------------------------------|------|
| 59350GZ | Service Truck Deluxe Package | |

59350GZ

The **DCX 20 FILL SYSTEM** comes with its own 20 lb pail and adds to or fills extinguishers, via gravity, in seconds. Pail changes out easily, due to a fast-connect clamp system. The can is constructed from spun aluminum with a white powder-coated finish. A three-tier screen system sifts powder, while a 1/2" valve holds back the powder until you're ready to dispense it.

| P/N | DESCRIPTION | EACH |
|---------|------------------------------------|------|
| 59341GZ | DCX 20 Extinguisher Filling System | |
| 51899GZ | Ball Valve, 1/4" | |
| 53343GZ | DCX 20 Clamp | |
| 53400GZ | 20 lb Lid | |
| 53401GZ | 20 lb Bucket | |
| 53414GZ | Male Quick Connect | |
| 53433GZ | Rubber Seal Strip, 3 1/2" | |
| 59403GZ | Discharge Hose, 3' x 3/8" | |



59341GZ

The easy-to-use **BLOW-OUT BAG** empties dry chemical extinguishers in seconds without a mess, saving time and money. Place nozzle or hose into bag, hold securely, and release pressure slowly (until empty). Hook-and-loop closure across the bottom makes it easy to empty.

WARNING: Do not mix chemicals! Not recommended for reclaiming chemicals.

| P/N | DESCRIPTION | EACH |
|------|--------------|------|
| BBAG | Blow-Out Bag | |



BBAG



PPB1

POWDER PAIL BAGS control the flow of powder, keeping dust to a minimum. Also fills hoppers.

| P/N | DESCRIPTION | EACH |
|------|-----------------|------|
| PPB1 | Powder Pail Bag | |

RUBBER Mallet for "fluffing" chemical in cylinders, etc.

| P/N | DESCRIPTION | EACH |
|------|---------------------|------|
| RM16 | 16 oz Rubber Mallet | |



RM16



RP9500

The disposable **DUST MASK** blocks non-toxic dusts, powders, and pollen. Lightweight with adjustable elastic head strap and metal forming strip over nose for comfort.

| P/N | DESCRIPTION | EACH |
|--------|-------------------|------|
| RP9500 | Dust Mask, Pkg/50 | |

The **CYLINDER VALVE GUARD** and **CAP** meet DOT, OSHA, and MSHA requirements. **GT11** can be fitted and padlocked over cylinder valve with regulator attached, while the **CCAP** protects cylinder valves only. Measures 3 7/8" x 11 threads per inch.

| P/N | DESCRIPTION | EACH |
|------|----------------------|------|
| GT11 | Cylinder Valve Guard | |
| CCAP | Cylinder Cap | |



CCAP

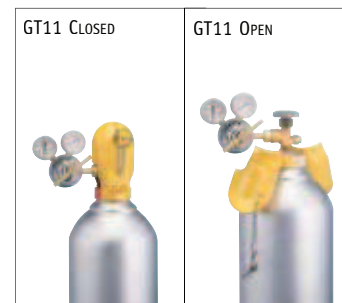

GT11 CLOSED

GT11 OPEN





SSPRCG1000

RECHARGE GAUGES feature all-stainless, all-welded construction with only 1% fluctuation in accuracy. Specifications include 3 1/2" dial size, 1/4" NPT lower connection, and a 0–1,000 psi range in increments of 10 psi. Meets NFPA 10 requirements for pressurizing extinguishers and is re-calibratable.

| P/N | DESCRIPTION | EACH |
|------------|------------------------|-----------------|
| SSPRCG1000 | Recharge Gauge | |
| SSPRCG | Re-Calibration Service | CALL FOR PRICES |



2550

The **NITROGEN REGULATOR** set-up is for recharging extinguishers. The regulator has a spring type (re-seating) safety relief, CGA580 inlet connection, 1/4" NPT female outlet, high-strength rubber diaphragm, and a rugged all-metal body. Comes with part number **NITA** and a one-year factory warranty. Outlet pressure 0–500 psi.

| P/N | DESCRIPTION | EACH |
|-------|--|------|
| 2550 | Nitrogen Regulator w/ NITA (Hose Not Included) | |
| N10H | 10' High-Pressure Nitrogen Hose | |
| 1000G | 1,000 psi Replacement Gauge for Nitrogen Regulator | |
| 4000G | 4,000 psi Replacement Gauge for Nitrogen Regulator | |
| NITA | Nitrogen Valve to Regulator Adapter | |
| C02 | 1/4" F x 1/4" F CO ₂ Coupling | |



N10H, NITA, C02



NITA

This **3-WAY VALVE** provides an easy and safe method of venting pressure when charging dry chemical and other low-pressure fire extinguishers. After reaching the correct extinguisher pressure and installing the extinguisher's pull pin, a half turn of the three-way valve handle instantly bleeds off the pressure between the **3WV** and the extinguisher (with minimal loss of nitrogen) for safe removal of the quick disconnect (**QDC** or **QDC2**). Use the **4HN** nipple to attach the quick disconnect. Maximum pressure is 500 psi.

| P/N | DESCRIPTION | EACH |
|-----|---------------------------------------|------|
| 3WV | 3-Way 1/4" Valve | |
| 4HN | 1/4" M x M Hex Nipple for 3-Way Valve | |



3WV



4HN



3WV, 4HN

SCALES

Use the **ADJUSTABLE SPRING DIAL PLATFORM SCALE** to weigh extinguishers during recharge. Corrosion-resistant, shatter-proof window, and easy to use. Comes with zero adjustment knob. 13" x 13" platform.

| P/N | DESCRIPTION | EACH |
|------|--|------|
| T100 | 100 lb x 4 oz Adjustable Spring Dial Scale | |



T100



T40

Built to withstand the demands of a commercial kitchen, this **HEAVY-DUTY, HIGH-PERFORMANCE TABLETOP SCALE** is made from heavy-gauge steel and features a large, angled dial with a shatterproof lens. The scale's platform measures 9" x 9", while the entire unit measures 7 1/4"L x 10 3/8"H x 10 7/8"W.

| P/N | DESCRIPTION | EACH |
|-----|--|------|
| T40 | 40 lb x 2 oz Heavy-Duty Tabletop Scale | |



These **LEGAL-FOR-TRADE PORTION SCALES** are perfect when fast and easy portion control is required. Incorporating a portable, wireless design, these scales feature over/under check weighing, removable stainless steel platforms, and adjustable auto shut off. Plus each one includes an automatic/semi-automatic zero-setting mechanism. Scales operate on four D-cell batteries or an AC adapter (both sold separately).

| P/N | DESCRIPTION | EACH |
|----------|--|--------------|
| BDS160 | 160 oz x 0.1 oz Digital Scale (4 D-Cell) | |
| BACA160 | AC Adapter for 160 oz Scale | |
| LTDS60 | 60 lb x 0.02 lb Digital Scale (4 D-Cell) | |
| LTDSAC60 | AC Adapter for 60 lb Scale | |
| ALK95 | D Alkaline Battery | SEE PAGE 142 |



BDS160

These **CLASS 7 WEIGHTS** are for scale calibration. The amendment of CA Title 19, Division 1, Chapter 3, states that scales must be checked with an appropriate **Class 7 Weight** prior to each use. Test weights are made from cast iron and coated with a layer of chip-resistant paint to keep them from corroding.

| P/N | DESCRIPTION | EACH |
|---------|----------------------|------|
| GHCW101 | 1 lb Class 7 Weight | |
| GHCW110 | 10 lb Class 7 Weight | |



GHCW110

Brooks' PRECISION HANGING SCALES are accurate, dependable, and feature an adjustable pointer and painted steel finish.

| P/N | DESCRIPTION | EACH |
|-----|-----------------------------|------|
| 101 | 110 lb x 1 lb Hanging Scale | |
| 501 | 50 lb x 1 lb Hanging Scale | |

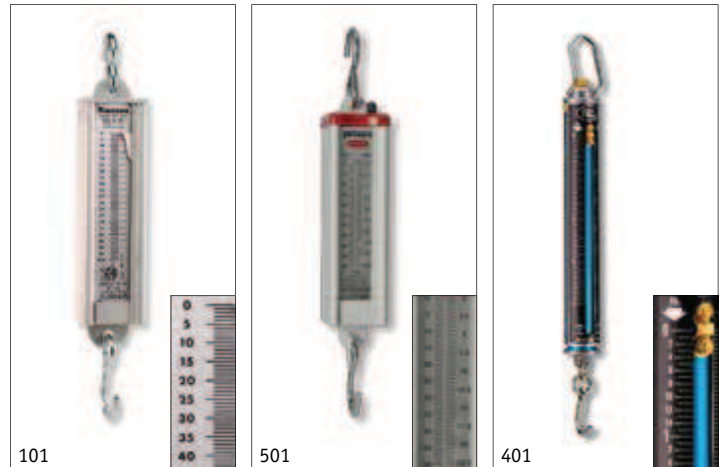

101

501

401

Brooks' PORTABLE HANGING SCALES are for weighing cartridges. Scale **605** is marked 0–60 ozs with 1/2 oz graduations. Scale **401** is marked 0–4 lbs with 1 oz and 0–2kg with 20gm graduations. The **SCLIP** (sold separately) is used for hanging cartridges.

| P/N | DESCRIPTION | EACH |
|-------|---|------|
| 401 | 4 lb x 1 oz Hanging Scale | |
| 605 | 60 oz x 1/2 oz Hanging Scale | |
| SCLIP | CO ₂ & Nitrogen Cartridge Scale Clip | |



605

SCLIP
IN USE

Heavy-duty **UTILITY SCALE** with 18-gauge steel case, memory lock, carrying handle, zero adjustment knob, and reinforced rib platform. Measures 13 1/4" L x 3 7/8" H x 10 1/2" W.

| P/N | DESCRIPTION | EACH |
|-------|-----------------------------|------|
| US100 | 100 lb x 1 lb Utility Scale | |
| US250 | 250 lb x 1 lb Utility Scale | |



US100

DKS3002

ELECTRONIC DIGITAL SCALE for cartridge filling and inspection. Features LCD digital display and automatic shut off. Operates on either a 9V battery or AC adapter (both sold separately). Measures 5 15/16" x 4 3/4" (platform) with a 2,000gm x 2gm capacity. **NOTE:** Call manufacturer on warranty issues.

| P/N | DESCRIPTION | EACH |
|---------|---|--------------|
| DKS3002 | 80 oz x 0.1 oz Electronic Digital Scale | |
| ODS230 | AC Adapter for DKS3002 | |
| ALK22 | 9V Alkaline Battery | SEE PAGE 142 |

SEE PAGE 142





PBB135

This **BENCH BEAM SCALE** is legal for trade, conforming to NIST Handbook 44, Class III. Scale features a bubble level indicator, adjustable leveling legs, and reads in ounces or decimal pounds with 135 lb x 0.1 lb graduations. Platform measures 12" x 17".

| P/N | DESCRIPTION | EACH |
|--------|------------------|------|
| PBB135 | Bench Beam Scale | |



WSK30350

SERVICE KITS

Reduce service time, while increasing profit, with the **UNIVERSAL WHEELED UNIT SERVICE KIT**. Our 30 lb–350 lb Service Kit has all the fittings, adapters, and components to perform annual maintenance on most makes, models, and sizes of wheeled fire extinguishers. Contact our Sales Department for a complete list of kit components.

| P/N | DESCRIPTION | EACH |
|----------|--------------------------|------|
| WSK30350 | Wheeled Unit Service Kit | |



DCRK

DRY CHEMICAL REFILLING KIT contains a small funnel (**FF1**), large funnel (**FF2**), regulator (**2550**), large scoop (**NAS2**), complete recharge adapter kit (**RAKIT**), nitrogen hose (**N10H**), and **PTFE** tape (**T520**).

| P/N | DESCRIPTION | EACH |
|------|----------------------------|------|
| DCRK | Dry Chemical Refilling Kit | |



SUKIT

START-UP KIT

Brooks' START-UP KIT easily outfits a service truck and contains everything you need to get the ball rolling. Contents include a dry chemical recharge kit (**DCRK**), valve stem kit (**VSKIT**), o-ring kit (**ORKIT**), rivet kit (**RAKIT**), 100 new-type pull pins (**NPP**), box of comfort masks (**RP9500**), valve cleaning brushes (**VCB**, **NB**, **TB**), scales (**501**, **605**), tube of lubricant (**OLUBE**), clear parts box (**LPC16**), and a parts bin rack (**PBR1**).

| P/N | DESCRIPTION | EACH |
|-------|-----------------------------------|------|
| SUKIT | Start-Up Extinguisher Service Kit | |



RAKIT

RECHARGE ADAPTER KIT contains 13 recharge adapters (**ADSET**), one **AD31**, 13 connectors (**CON1**), one **GDC**, and one **AC1** in a clear parts bin box with a full-scale illustration of each part.

| P/N | DESCRIPTION | EACH |
|-------|----------------------|------|
| RAKIT | Recharge Adapter Kit | |



RECHARGE ADAPTERS

Fire extinguisher **RECHARGE ADAPTERS, AIR VALVES, and QUICK DISCONNECT COUPLERS.**

| P/N | DESCRIPTION |
|---------|---|
| AD21 | Recharge Adapter Fits Amerex, Badger, General, Old Kidde, Pemall, Flag, & RC Ind. |
| AD22 | Recharge Adapter Fits Ansul Sentry 2½ lb & 5 lb Coarse Thread (Small Valve) |
| AD23 | Recharge Adapter Fits Ansul, Buckeye, Pyronauts, & Kidde (Large Pro Line Units) |
| AD24 | Recharge Adapter Fits Amerex, Ansul, Badger, General, Pemall, Strike, Stop Fire, Buckeye, Flag, Power-Pak, & RC Ind. |
| AD25 | Recharge Adapter Fits Old-Style Kidde Units |
| AD26 | Recharge Adapter Fits RC Ind. Clip Type Nozzle |
| AD27 | Recharge Adapter Fits Kidde Nylon Valve w/ Nozzle |
| AD29 | Recharge Adapter Fits Fyr-Fyter, Buffalo, C-0-Two, Pyrene, Norris, & Stop Fire |
| AD30 | Recharge Adapter Fits All Ansul Sentry Units Except 2½ lb (Large Valve) |
| AD32 | Recharge Adapter Fits Kidde Nylon Valve w/ Hose |
| AD34 | Recharge Adapter Fits Kidde Coarse Thread |
| AD35 | Recharge Adapter Fits Kidde Pro Line (Small Units) & New Ansul Sentry |
| AD36 | Recharge Adapter Fits Amerex 270, 272, B260, & B262 |
| → AD36W | Washer for AD36 |
| → AD38 | Recharge Adapter Fits Ansul A02S & A02SVB |
| ADSET | Complete Set of Recharge Adapters AD21-27, 29, 30, 32, 34, 35, 36, & 38 |

EACH



Fire extinguisher **RECHARGE ADAPTERS, AIR VALVES, and QUICK DISCONNECT COUPLERS.**

| P/N | DESCRIPTION |
|------|--|
| CRT | Core Removing Tool |
| AC1 | Air Chuck |
| AV1 | Air Valve w/ Cap |
| CORE | Replacement Core for AV1, Pkg/50 |
| AVC | Replacement Cap for AV1, Pkg/50 |
| CON1 | Male Quick Disconnect 1/8" NTP (Male) Use w/ all AD Recharge Adapters |
| CON2 | Male Quick Disconnect 1/8" NTP (Male) Use w/ all AD Recharge Adapters on Getz Recharge System |
| AD31 | Male Quick Disconnect 1/4" NPT (Male) Use w/ DCA & AC1 |
| QDC | Female Quick Disconnect 1/4" NPT (Female) Use w/ CON1 & AD31 |
| QDC2 | Female Quick Disconnect 1/4" NPT (Female) Use w/ CON2 on Getz Recharge System |
| DCA | Discharge Adapter for Cartridge Receiver Fits Ansul, Badger, & General |

EACH

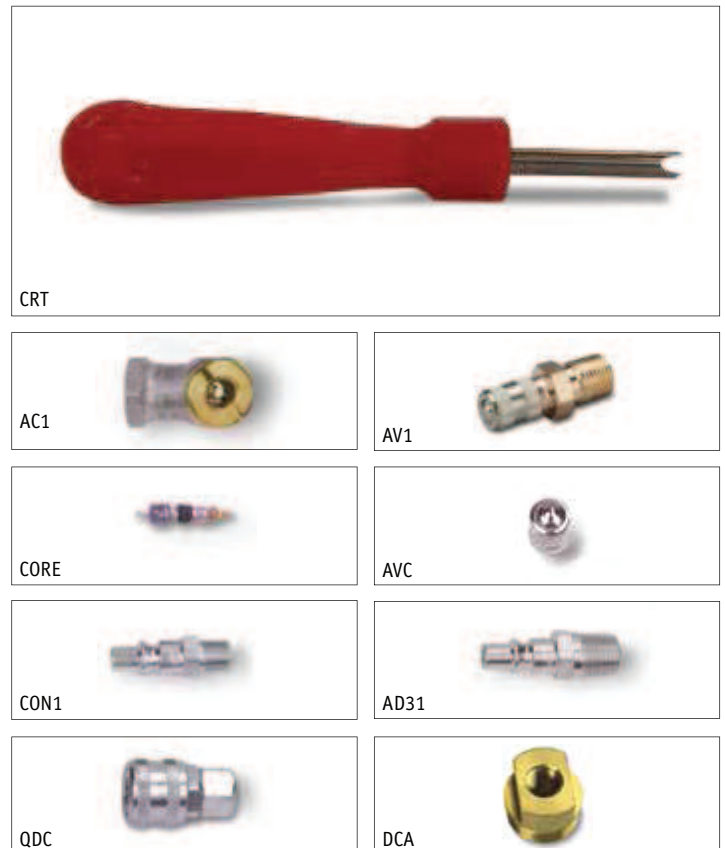

CO₂ RECHARGE EQUIPMENTCO₂ CHARGING LINE COMPONENTS

| P/N | DESCRIPTION | EACH |
|-------|--|------|
| C01 | 1/2" F x 1/4" F CO ₂ Coupling | |
| C02 | 1/4" F x 1/4" F CO ₂ Coupling | |
| C07P | Fiber Washer for Swivel Nut, Pkg/50 | |
| C014P | Nylon "Snap In" Washer, Pkg/50 | |
| C08 | 1/8" F x 1/2" M CO ₂ Charging Adapter | |
| C09 | 1/4" F x 1/2" M CO ₂ Charging Adapter | |
| C010 | 3/8" F x 1/2" M CO ₂ Charging Adapter | |
| C011 | 1/2" F x 1/2" M CO ₂ Charging Adapter | |

CO₂ CHARGING LINE COMPONENTS

| P/N | DESCRIPTION | EACH |
|---------|---|------|
| C012 | 1/2" F Plastic Hand Nut | |
| C013 | 2 1/2" Brass Nipple | |
| C015 | Flip Valve 1/4" F x 1/4" F | |
| 72194RS | Valve Stem for C015 | |
| C016 | 5 lb CO ₂ Charging Adapter | |
| C017 | Brass Swivel Nut | |
| C03 | 6' Charging Hose 1/4" M x 1/4" M | |
| C04 | Heavy-Duty Quarter-Turn Ball Valve (2,000 WOG-CS) | |



Specially designed for paintball cylinders, this **RECHARGE KIT** features a single 1,000 psi WOG CO₂ brass ball valve and a CO₂ pin depressor for safe filling and handling.

Warning: This kit is for refilling paintball cylinders only. A scale must be used to insure a safe fill. For indoor use only.



| P/N | DESCRIPTION | EACH |
|--------|---------------------------------|------|
| PBRKIT | Paintball Cylinder Recharge Kit | |

VALVE HANDLE GRIP for holding squeeze-handle-type valves in the open position. Made in the USA.

| P/N | DESCRIPTION | EACH |
|-----|-------------------|------|
| VHG | Valve Handle Grip | |



NOTE: The above adapters and components are only a partial list of items and equipment needed to safely refill carbon dioxide cartridges and cylinders. These adapters and components should be purchased and used **only** by personnel who are thoroughly familiar with, and understand, the standards published in the Compressed Gas Association pamphlets G-6 and S-1.1, Code of Federal Regulations Title 49, Parts 100 thru 185, and who have received "hands-on" training under the direct supervision of someone experienced in cartridge refilling. If you lack the knowledge, training, or experience described above, **do not** attempt to refill carbon dioxide cartridges or cylinders. Instead, we recommend that you purchase either new cylinders and cartridges or have them refilled by an established service facility. **Failure to adhere to the above instructions could result in serious injury or death!**



HYDROTEST EQUIPMENT

LOW-PRESSURE HYDROTEST PUMP made of cast aluminum. Comes with stainless steel pistons and pressure gauge, with 0–1,000 psi rating. Order hose (**N10H**) and quick disconnect coupler (**QDC**) separately. Shipping weight is 12 lbs.

| P/N | DESCRIPTION | EACH |
|-------|---|--------------|
| HTP | Hydrotest Pump (Pump Only) | |
| HPCS | Replacement Check Stem Kit for Hydrostatic Test Pump | |
| N10H | 10' High-Pressure Nitrogen Hose | SEE PAGE 172 |
| 1000G | 1,000 psi Replacement Gauge for Hydrostatic Test Pump | SEE PAGE 172 |
| QDC | Quick Disconnect Coupler | SEE PAGE 169 |
| OR27 | O-Ring for Piston (2 Required) | SEE PAGE 208 |



HTP, QDC, N10H

Brooks' TEST CAGE is manufactured to meet NFPA 10 8.2.4.1. Comes with durable red powder paint finish, 13-gauge steel mesh, and 11-gauge steel frame with mounting holes on the bottom. Top of cage has a 1½" hole for test hose. Hinged door with latch for easy access standard too. Shipping weight is 29 lbs. Measures 31"H x 12"W x 11"D.

| P/N | DESCRIPTION | EACH |
|-----|-------------|------|
| TC | Test Cage | |



TC

This **Getz CYLINDER DRYING RACK** dries up to five 20 lb extinguishers or one 30 lb extinguisher in just minutes. Operates off a standard 120VAC outlet and comes with a 6' power cord. Unit features a three-position switch—off, on/cold, on/hot—and can run continuously without overheating.

| P/N | DESCRIPTION | EACH |
|------------|---|------|
| 59339GZ | Mobile or Shop Drying System | |
| DDP59401GZ | Replacement Heating Tube | |
| DDP53349GZ | Motor Fan for Mobile Drying System | |
| DDP53355GZ | Electric Rocker Switch for Mobile Drying System | |
| 59453GZ | Heating Element | |



59339GZ

The **CYLINDER DRYER** cuts time servicing cylinders by speeding up the drying time. Dryer is 1,400W at 1/3 hp and connects to a standard 110VAC outlet with its 20' cord.

| P/N | DESCRIPTION | EACH |
|---------|-----------------------------|------|
| 59705GZ | Getz Cylinder Dryer | |
| CD2969 | Replacement Brush w/ Spring | |
| CD5238 | Replacement Heating Element | |



59705GZ



Certified Genuine



SSPTG1000

The **CERTIFIED TEST GAUGE** for hydrostatic testing of low-pressure cylinders (required by NFPA 10), meets test gauge requirements for both volumetric expansion and modified hydrostatic (proof pressure) testing of DOT-specified cylinders. An additional gauge should be used as a master gauge for a daily system check, as required by NFPA 10. Features 0–1,000 psi range, .25% accuracy (full scale), and 5 psi minor graduations. Externally adjustable dial measures 4½" with the gauge having a ¼" NPT lower connection that fits the **HTP** test pump. Gauge is calibrated and certified prior to shipment. **Brooks** can deadweight test and recertify your test or master gauges in our Charlotte, N.C. location. Send carefully packed gauges (with ALL adaptors removed), marked "GAUGE SHOP," to our Charlotte address. Your re-certified gauge will be shipped back within two business days of receipt (using the same method of shipment unless otherwise instructed). Not for high pressure testing!

WARNING: Not responsible for damage due to adaptors not being removed before shipping! Brooks cannot repair damaged gauges!

| P/N | DESCRIPTION | EACH |
|-----------|------------------------------------|-----------------|
| SSPTG1000 | 1,000 psi Certified Test Gauge | |
| SSPDW11 | Deadweight Test & Re-Certify Gauge | CALL FOR PRICES |



DDP59327GZ

Our **Getz DUAL-GAUGE ASSEMBLY** meets the same requirements of our certified test gauges and includes two 4½" (0–1) 100 psi mirrored-dial gauges, a dual 45° gauge block with an air-bleed valve, and drain line. It features a shutoff valve at the working and master gauge assembly, 6' of pressure line, and a shutoff valve for connecting to your existing pump. Mounting bracket included.

| P/N | DESCRIPTION | EACH |
|------------|---------------------|------|
| DDP59327GZ | Dual Gauge Assembly | |

CYLINDER INSPECTION LIGHTS come with a protective cover/extension. Flexible shaft can be bent to desired angle. Batteries included. Krypton bulb fits either light.

| P/N | DESCRIPTION | EACH |
|--------|--|------|
| 24CIL | 24" Cylinder Inspection Light, Krypton Lamp | |
| 16CIL | 16" Cylinder Inspection Light, Standard Lamp | |
| 110KRP | Krypton Replacement Bulb | |
| 100S | Standard Replacement Bulb | |



16CIL

Streamlight® Stylus® PENLIGHTS conveniently clip to things like your shirt pocket and produce 11 lumens of powerful white light when needed. Penlight features a 100,000-hour LED that you can switch from constant-on to momentary blink. And with a knurled anodized aluminum body, they're easy to hang on to. They're also water-resistant and use three AAAA- cell batteries (included). CE approved. Black.

| P/N | DESCRIPTION | EACH |
|---------|---|------|
| SL65618 | Reach Penlight, 14" (Extended), 6¾" (Retracted) | |
| SL65030 | Replacement AAAA Batteries, Pkg/6 | |



SL65618

INSPECTION MIRRORS include the **IM**, which telescopes from 5⅝" to 19½" and features an adjustable ⅞" Dia. mirror and magnetic end. The **SIM** is 9¼" long with a fixed ⅝" Dia. mirror.

| P/N | DESCRIPTION | EACH |
|-----|-------------------------|------|
| IM | Inspection Mirror | |
| SIM | Small Inspection Mirror | |



IM



SIM



HYDROTEST ADAPTERS

Low-pressure **HYDROTEST ADAPTERS** for portable extinguishers and system cylinders.

| P/N | DESCRIPTION |
|--------|--|
| HTA1 | General Extinguisher Hydrotest Adapter |
| HTA10R | O-Ring for HTA1 |
| HTA20R | O-Ring for HTA2 |
| HTA3 | Hydrotest Adapter Fits Badger & American LaFrance Extinguishers |
| HTA5 | Hydrotest Adapter Fits General & Kidde Extinguishers |
| HTA7 | Hydrotest Adapter Fits Buckeye, General, Pemall, PowerPak, Pyronauts, & RC Ind. Extinguishers |
| HTA9 | Hydrotest Adapter Fits Amerex, Ansul, Badger, & American LaFrance Extinguishers |
| HTA10 | Hydrotest Adapter Fits Amerex, Badger, General, & Kidde Water Pressure Extinguishers |
| HTA10G | Gasket for HTA10 |
| HTA11 | Hydrotest Adapter Fits Amerex & Ansul Extinguishers |
| HTA12 | Hydrotest Adapter Fits Ansul & General Extinguishers |
| HTA13 | Ansul Extinguisher Hydrotest Adapter |
| HTA14 | Kidde Extinguisher Hydrotest Adapter |
| HTA15 | General Extinguisher Hydrotest Adapter |
| HTA16 | Kidde Extinguisher Hydrotest Adapter |
| HTA17 | Kidde Extinguisher Hydrotest Adapter |
| HTA18 | Kidde Extinguisher Hydrotest Adapter |
| HTA19 | Hydrotest Adapter Fits American LaFrance & Stop Fire Extinguishers |

Low-pressure **HYDROTEST ADAPTERS** for portable extinguishers and system cylinders.

| P/N | DESCRIPTION |
|---------|---|
| HTA20 | General Extinguisher Hydrotest Adapter |
| HTA21 | Pemall Extinguisher Hydrotest Adapter |
| HTA23 | Hydrotest Adapter Fits Old-Style Range Guard Systems & Fyr-Fyter systems |
| HTA24 | Hydrotest Adapter Fits Kidde, Pyro-Chem Systems, & Badger Range Guard Systems |
| HTA39 | Kidde Extinguisher Hydrotest Adapter |
| HTA41 | Hydrotest Adapter Fits Pyro-Chem Wet System |
| HTA410R | O-Ring for HTA41 |
| HTA42 | Steel Cylinder Hydrotest Adapter UL300 |
| HTA43 | Hydrotest Adapter Fits Ansul Dry Chem & Cleanguard Extinguishers |
| HTA45 | Hydrotest Adapter Fits Badger & American LaFrance Extinguishers (10-20 lb Large Valve) |
| HTA44 | Badger Extinguisher Hydrotest Adapter |
| HTA46 | Hydrotest Adapter Fits Ansul Water & Wet Chem Extinguishers |
| 51041GZ | Adapter for HTAs w/ Getz Hydrostatic Test Equipment |
| 4892A | Hydrotest Adapter (Cylinder Hose Opening) Fits Amerex DC Wheeled Units |

Low-pressure **HYDROTEST ADAPTERS.**

| P/N | DESCRIPTION |
|--------|---|
| AGTSET | Hydrotest Adapter Set Fits Ansul & General Cartridge Units |
| 14BV | Miniature Ball Valve (1/4" Pipe Thread) |
| 5720A | Hydrotest Adapter Fits CEH75 Chemical Engine Hose |
| AD31 | 1/4" Quick Disconnect Recharge Adapter |
| QDC | Quick Disconnect Coupler |
| QDC2 | Quick Disconnect Coupler Fits Getz Recharge Systems |

EACH



EACH



EACH



2014 © BROOKS EQUIPMENT COMPANY, LLC

SEE PAGE 175
SEE PAGE 169
SEE PAGE 175





High-pressure **HYDROTEST ADAPTERS** for use in water jacket high-pressure test units.

| P/N | DESCRIPTION | EACH |
|---------|---|------|
| HPTA27 | 1 1/8" UNE, Aluminum Cylinders & Extg. | |
| HPTA28 | 3/4" UNE, Scott Air Cylinders-II & Aluminum ICC 2015, Sportsway Dive Tanks & Others | |
| HPTA29* | 7/8" UNE, Scott Air Cylinders-III & Others | |
| HPTA32 | 1/2" NGT, Commerical Gas Cylinders & CO ₂ Extg. | |
| HPTA33 | 3/4" NGT, Commerical Gas Cylinders & CO ₂ Extg. | |
| HPTA34 | 1" NGT, Commerical Gas Cylinders & CO ₂ Extg. | |
| HPTA35 | 3/4" Straight Pipe, Dive, Scuba, & Aqua Tanks | |
| HPTA36 | 1/2" Straight Pipe, MSA, & Others | |
| HPTA37 | 1 1/4" UNE, Aluminum Cylinders & Extg. | |
| HPTA38 | 3/4" UNE, MSA, FRP, & Others w/o O-Ring Groove | |

*WHILE QUANTITIES LAST!



High-pressure **CARTRIDGE HYDROTEST ADAPTERS** to be used in water jacket high-pressure test units.

| P/N | DESCRIPTION | EACH |
|------|--|------|
| CTA1 | Left-Hand Thread, High-Pressure Test Adapter Fits Ansul & General Cartridges | |
| CTA2 | Right-Hand Thread, High-Pressure Test Adapter Fits Ansul & General Cartridges | |



STAMP HOLDER AND STAMPS

Custom **DOT IDENTIFICATION STAMP** with your Department of Transportation identification number. Comes in your choice of sharp or low stress. Delivery is two to three weeks.

NOTE: Signed proof required for production of custom DOT stamps.



| P/N | DESCRIPTION | EACH |
|---------|-----------------------------|------|
| SSPDOTL | Custom Low-Stress DOT Stamp | |
| SSPDOTS | Custom Sharp DOT Stamp | |

DOT METAL STAMPS with 1/4" characters.

| P/N | DESCRIPTION | EACH |
|--------|------------------------------|------|
| MS3AL | "3AL" Low-Stress Metal Stamp | |
| MSP | Plus (+) Symbol Stamp | |
| MSST | Star Symbol Stamp | |
| MS14SD | Sharp Face Metal Stamp "14" | |
| MS14LD | Low-Stress Metal Stamp "14" | |

Heavy-duty **STEEL STAMPS** are manufactured to meet the most demanding industrial applications with an extra-heavy, extra-long shank and supporting bevel. Each stamp features character identification, size, and three thumb grooves. Stamps cut 1/4" numbers.



| P/N | DESCRIPTION | EACH |
|------|------------------------------|------|
| MS | Steel Stamp Set (0-9 Stamps) | |
| MS0 | Number 0 Steel Stamp | |
| MS1 | Number 1 Steel Stamp | |
| MS2 | Number 2 Steel Stamp | |
| MS3 | Number 3 Steel Stamp | |
| MS4 | Number 4 Steel Stamp | |
| MS5 | Number 5 Steel Stamp | |
| MS6 | Numbers 6 & 9 Steel Stamp | |
| MS7 | Number 7 Steel Stamp | |
| MS8 | Number 8 Steel Stamp | |
| MSLS | Low-Stress Stamp Set (0-8) | |



Quickest, Safest, Easiest Way To Remove O-Rings!

O-RING REMOVAL KIT consists of a handle and four different tools in a handy vinyl storage pouch.

P/N **DESCRIPTION**
 ORRK O-Ring Removal Kit

EACH



ORKK

MISCELLANEOUS

TOOL HOLDER securely holds steel stamps and other tools.

P/N **DESCRIPTION**
 HSH Tool Holder

EACH



HSH IN USE

TWO-POUND STAMPING HAMMER is ideal for hitting stamps and leaving a readable imprint every time. The short 8" shaft allows for easy control and the 2 lb weight makes the stamp impression readable.

P/N **DESCRIPTION**
 SH2 2 lb Stamping Hammer

EACH



SH2

BRUSHES for cleaning valves, threads, etc.

P/N **DESCRIPTION**
 VCB Metal Bristle Cleaning Brush
 BVCB Brass Bristle Cleaning Brush
 For Aluminum
 NB Nylon Bristle Cleaning Brush
 TB Cleaning Brush
 NWB Nylon Cleaning Brush
 BWB Brass Cleaning Brush
 WB Nylon Wire Brush
 CWB Industrial-Grade Wire Brush
 PDB 6" Pipe Dope Brush

EACH

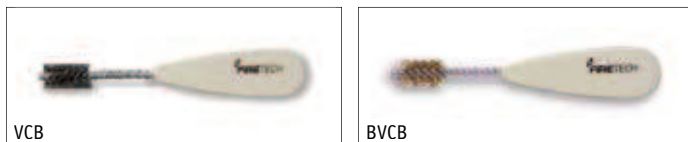

VCB

BVCB

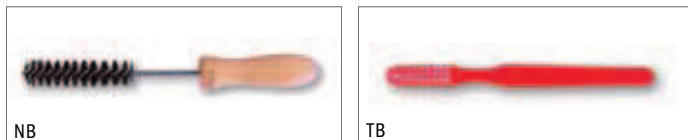

NB

TB



NWB

WB

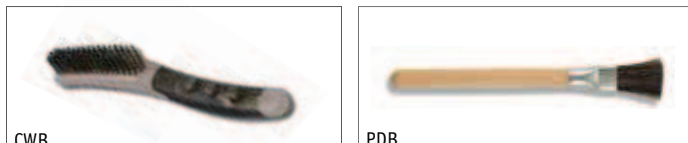

CWB

PDB

INSPECTION MIRRORS include the **IM**, which telescopes from 5³/₈" to 19¹/₂" and features an adjustable 7⁷/₈" Dia. mirror and magnetic end. The **SIM** is 9¹/₄" long with a fixed 5⁵/₈" Dia. mirror.

P/N **DESCRIPTION**
 IM Inspection Mirror
 SIM Small Inspection Mirror

EACH



IM



SIM





PWGT



LD1

GAUGE SERVICE EQUIPMENT

GAUGE TESTER for pressurized water extinguishers allows you to check gauge while unit is pressurized. Features rugged bronze bourdon tube and brass movement. Holds pressure until released. Doubles as a tire gauge. Complete with operating instructions.

| P/N | DESCRIPTION | EACH |
|------|--------------|------|
| PWGT | Gauge Tester | |

BUBBLES LEAK DETECTOR adheres to overhead surfaces, leaves no residue, and dries clean and clear. Patented self-storing "Squirtables" have small bores for dispensing small quantities. Okay for CO₂, nitrogen, and halon.

| P/N | DESCRIPTION | EACH |
|-----|--------------------------------------|------|
| LD1 | Squirt'n Bubbles Leak Detector, 8 oz | |



GWRENCH

The steel **GAUGE WRENCH** is designed specifically for removing and attaching most gauges. Cold-rolled plated steel, 3/16" thick.

| P/N | DESCRIPTION | EACH |
|---------|--------------|------|
| GWRENCH | Gauge Wrench | |



PTPBK, PTPBL

PENS AND MARKERS

With its pressurized ink technology, **Uni-Ball® POWER TANK BALL POINT PENS** are retractable and meet the challenges of adverse writing conditions—wet surfaces or writing at any angle. Writes smoothly, even in extreme cold or when it's upside down.

| P/N | DESCRIPTION | EACH |
|-------|-----------------------|------|
| PTPBK | Power Tank Pen, Black | |
| PTPBL | Power Tank Pen, Blue | |

Sharpie® PERMANENT MARKING PENS for marking on metal, plastic, vinyl, etc.

| P/N | DESCRIPTION | EACH |
|------|---|------|
| PMC | King-Size Permanent Marking Pen, Black | |
| PMP | Fine Permanent Marking Pen, Black | |
| PMF | Extra-Fine Permanent Marking Pen, Black | |
| PMFR | Extra-Fine Permanent Marking Pen, Red | |
| MMP | Metal Marking Pen, Black | |



PMC



PMP



PMFR



MMP

Sharpie® medium-point PAINT MARKERS are permanent oil-based valve-action paint pens that mark on virtually any surface—metal, pottery, wood, rubber, glass, plastic, stone, etc. Quick drying, they're also fade, water, and abrasion resistant for a long-lasting, durable mark. Non-toxic and **Xylene** free.

| P/N | DESCRIPTION | EACH |
|--------|---------------------------|------|
| PTMPBK | Paint Marking Pen, Black | |
| PTMPR | Paint Marking Pen, Red | |
| PTMPY | Paint Marking Pen, Yellow | |



PTMPY

With **Sharpie's** fine point **RETRACTABLE PERMANENT MARKERS**, there's no cap to lose, which makes for easier one-handed operation. Its **Safety Seal™ Valve** prevents drying out and the quick-drying, non-toxic ink writes on almost any surface.

| P/N | DESCRIPTION | EACH |
|---------|-------------------------------------|------|
| PMFRFBK | Retractable Permanent Marker, Black | |
| PMFRTR | Retractable Permanent Marker, Red | |



PMFRFBK



The Easy Way To Anchor

The **SnapToggle® ANCHOR** is a heavy-duty hollow wall anchor for use in walls, ceilings, or floors made from gypsum board, drywall with a steel stud, concrete block, and tile over drywall, etc. Its solid-metal channel secures the bolt and out holds wing toggles. The self-drilling **SnapSkrus®** anchors are the only version that locks symmetrically on the wall and ceiling for truly secure fastening. When activated with a screw, the **SnapSkrus** anchor opens with an audible “pop”, locking the anchor on the wall with much greater holding power than other self-drilling anchors.

| P/N | DESCRIPTION | EACH |
|---------|---|------|
| 25013ST | 3/16" SnapToggle Anchor (Toggle Bolt Only), Pkg/50 | |
| 50TOG | 3/16" x 1 1/2" Phillips Head Bolt for 25013ST, Pkg/50 | |
| 30012SS | SnapSkrus Self-Drilling Anchors, Pkg/50 | |



25013ST



30012SS



30012SS In Use

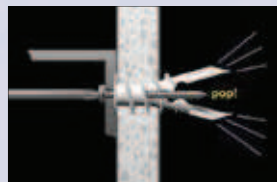

30012SS In Use



SNAPSKRUS VIDEO

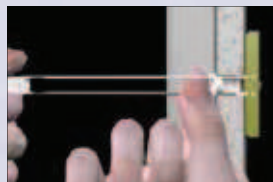

25013ST In Use

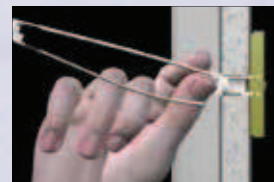

25013ST In Use



SNAPTGGLE VIDEO

FASTENERS

E-Z Anchor® SELF-DRILLING FASTENER requires no predrilling. Installs easily using a **Phillips®** screwdriver or power driver. Doesn't leave big, gaping holes when removed. Deep thread engagement for added strength in 3/8" to 3/8" wallboard (sheetrock). Your choice of plastic or zinc metal. Screws: #8 x 1 1/4". Items sold separately.

| P/N | DESCRIPTION | EACH |
|--------|--------------------------------------|------|
| EZP | E-Z Anchor Plastic Fastener, Pkg/100 | |
| EZM | E-Z Anchor Metal Fastener, Pkg/100 | |
| EZS100 | E-Z Anchor Screw, Pkg/100 | |



EZP



EZM

E-Z Toggle® SELF-DRILLING TOGGLE BOLT requires no predrilling. Installs easily using a **Phillips®** screwdriver or power driver. Won't leave big, gaping holes when removed. Unique, patented clamp replaces both 1/8" and 3/8" winged toggles. Deep thread engagement for added strength in 3/8" to 3/8" wallboard (sheetrock). Screws included.

| P/N | DESCRIPTION | EACH |
|-------|--------------------|------|
| EZTOG | E-Z Toggle, Pkg/50 | |



EZTOG



CA1

Tapcon® SELF-TAPPING CONCRETE ANCHORS are the fastest way to secure wall brackets and cabinets to concrete. Just drill pilot holes and screw them in. No plastic or metal plugs needed. Cuts their own threads into masonry. Holds strong in block, brick, or poured concrete. Use the **Condri Drive® 1000 INSTALLATION TOOL** for easy installation. 1/4" x 1 3/4".

| P/N | DESCRIPTION | EACH |
|-----|--------------------------------------|------|
| CA1 | Tapcon Self-Tapping Anchors, Pkg/100 | |
| CAT | Condri Drive 1000 Installation Tool | |



CAT





SELF-DRILLING STEEL FASTENERS will tap into $\frac{1}{4}$ " to $\frac{1}{2}$ " steel (no drilling needed). Hex head #12 x $1\frac{1}{4}$ " long-milled self-drillers feature a non-walking point with precise cutting edges. Screw's unique design increases drilling performance, requiring less end pressure.

| P/N | DESCRIPTION | EACH |
|-----|---------------------------------|------|
| SA1 | Self-Drilling Fastener, Pkg/100 | |



TOGGLE BOLTS and WASHERS.

| P/N | DESCRIPTION | EACH |
|------|--|------|
| RHTB | 3" x $\frac{3}{16}$ " Round Head Toggle Bolt, Pkg/100 | |
| FW1 | 1" x $\frac{3}{16}$ " Fender Washer, Pkg/100 | |
| FW15 | 1 $\frac{1}{2}$ " x $\frac{1}{4}$ " Fender Washer, Pkg/100 | |



PTFE TAPE

| P/N | DESCRIPTION | EACH |
|--------|--|------|
| T520 | White, $\frac{1}{2}$ " x 520" | |
| T75 | White, $\frac{3}{4}$ " x 520" | |
| T520HD | Hi-Density, Pink, $\frac{1}{2}$ " x 520" | |



Brooks' Sign On! ADHESIVE bonds signs to almost anything. Pkg/6 (priced each).

| P/N | DESCRIPTION | EACH |
|-----|----------------------------------|------|
| BA1 | Brooks' Sign On! Aerosol, 9.5 oz | |

Brooks' LUBE was made with the fire extinguisher industry in mind. Lubricates, cleans, penetrates, and protects parts. Pkg/6 (priced each).

| P/N | DESCRIPTION | EACH |
|-----|-----------------------------|------|
| BA2 | Brooks' Lube Aerosol, 11 oz | |



Brooks' Crazy Kleen multi-purpose INDUSTRIAL

STRENGTH CLEANER. Use it in the shop or at home. Pkg/6 (priced each).

| P/N | DESCRIPTION | EACH |
|-----|------------------------------------|------|
| BA4 | Brooks' Crazy Kleen Aerosol, 19 oz | |

AEROSOLS

Lift Off® ADHESIVE REMOVER is a patented formula that effectively removes adhesives, chewing gum, grease, tar, and motor oil. Pkg/12 (priced each).

| P/N | DESCRIPTION | EACH |
|------|---------------------------|------|
| LOAR | Adhesive Remover, 10.5 oz | |



SMOKE DETECTOR TESTER tests photoelectric and ionization detectors. Non-toxic. UL listed.

| P/N | DESCRIPTION | EACH |
|------|-------------------------------|------|
| FTS2 | Smoke Detector Tester, 2.6 oz | |

Gust PREMIUM EASY DUSTER is non-flammable, non-residual, and non-abrasive canned air. It has zero ozone depletion potential and is totally moisture-free. Delivers over 80 psi, easily removing dust and dirt from hard-to-reach places.

| P/N | DESCRIPTION | EACH |
|--------|----------------------------------|------|
| AB2000 | Canned Air (Non-Flammable) 10 oz | |



Outperforms Shop Rags!

Wypall® WIPERS provide better absorption than a shop rag and come in different thicknesses for different jobs. And since they're disposable, they keep workers healthier and shops cleaner. **Wypall** uses **Hydroknit®** technology to combine excellent absorbing power in a lightweight wiper that is reusable. They also take up less space than rags and install anywhere with a **JUMBO ROLL DISPENSER**.

| P/N | DESCRIPTION | QTY | EACH |
|----------|--|-----|------|
| KCW180 | Pop-Up Box Wipers, White, 12 ¹ / ₂ " x 16 ³ / ₄ " Replaces 25 lbs of Scrap Rags | 180 | |
| KCHDW475 | Jumbo Roll Wipers, Red, 12 ¹ / ₂ " x 13 ³ / ₈ " Replaces 75 lbs of Scrap Rags | 475 | |
| KCHDD | Jumbo Roll Dispenser, 16 ³ / ₄ "L x 33"H x 18 ¹ / ₂ "W | | |
| KCHWM | Jumbo Roll Wall Mount Dispenser, 16 ³ / ₄ "L x 8 ³ / ₄ "H x 10 ³ / ₄ "W | | |



KCW180



KCHDW475, KCHDD

HANDCARE PRODUCTS

Lava®, The Original Heavy-Duty HAND CLEANER, cuts through the heaviest grease and grime. Pumice-powered with moisturizers, **Lava** gets extremely dirty hands really clean without feeling rough. Removes dirt, grease, oil, ink, tar, paint, caulk, and adhesives. Available in traditional bar or liquid style. Made in the USA.

| P/N | DESCRIPTION | EACH |
|---------|--|------|
| LAVA | Individually Wrapped Bar Soap, 5.75 oz | |
| LAVA2 | Twin-Pack Bar Soap, 5.75 oz | |
| LAVALIQ | Liquid Soap, 7.5 oz | |



LAVA



LAVALIQ

GoJo® HAND CLEANERS are dermatologist tested and specially formulated to gently remove a variety of light greases and oils, effectively cleansing hands quickly—and without water.

| P/N | DESCRIPTION | EACH |
|-----------|---|------|
| GJS095806 | 1/2 gal Orange Pumice Hand Cleaner w/ Pump Dispenser | |
| GJW629804 | Fast Wipes Multi-Purpose Towels, 130-Count Bucket | |



GJW629804



GJS095806

For contractors and do-it-yourselfers, **Scott® RAGS IN A BOX** are specifically designed for hands-on work. These soft, absorbent towels perform with the strength, durability, and absorbency of a cloth. Comes in a **Pop-Up Box** with built-in handle for easy transport. White.

| P/N | DESCRIPTION | QTY | EACH |
|---------|--------------------------|-----|------|
| KCRB200 | Rags In A Box, 10" x 13" | 200 | |



KCRB200



KCST55

Scott® SHOP TOWELS are strong, soft, and absorbent towels that work like a cloth. They're great for wiping hands, cleaning tools, and easily absorb liquids, oil, and grease. For consistent quality and affordability, no other brand beats **Scott**. Fits on a standard towel holder for convenient dispensing of a fresh, clean towel. Blue.

| P/N | DESCRIPTION | QTY | EACH |
|--------|---|-----|------|
| KCST55 | Shop Towels, 10 ³ / ₈ " x 11" | 55 | |



TAPE

Duck® Brand DUCT TAPE is the leading duct tape in North America. 1.88" wide, 10 mil. Silver.

| P/N | DESCRIPTION | EACH |
|--------|----------------------|------|
| PDTAPE | Professional, 60 yds | |



PDTAPE

Made for all types of electrical jobs, except those exceeding 600ACV, **Duck® Brand UTILITY** and **ALL-PURPOSE ELECTRICAL TAPES** are 7 mil thick, 3/4" wide, UL listed, and CSA® certified. In addition, the **All-Purpose Tape** is flame retardant and weather-resistant. Black.

| P/N | DESCRIPTION | EACH |
|--------|---|------|
| EETAPE | Utility Electrical Tape, 60' | |
| PETAPE | Pro Series All-Purpose Electrical Tape, 66' | |



EETAPE



PETAPE

Duck® Brand HIGH-PERFORMANCE PACKAGING TAPE is a heavy-duty clear bulk tape that's ideal for sealing boxes and other jobs. It's 2.6 mil thick and meets postal regulations. 1.88" wide.

| P/N | DESCRIPTION | EACH |
|---------|---------------------------------------|------|
| HPTAPE6 | Heavy-Duty Bulk Tape, 54.6 yds, Pkg/6 | |



HPTAPE6

The **Duck® STANDARD TAPE GUN** features an adjustable tension control knob and has a comfortable handle. Holds up to 2"-wide tape.

| P/N | DESCRIPTION | EACH |
|---------|-------------------|------|
| TAPEGUN | Standard Tape Gun | |



TAPEGUN



TOOLS

Brooks' HEX NUT WRENCH fits **HTA** hydrotest adapters and pressurized water extinguisher neck rings. Adjustable from 1 1/4" to 2". Slim design to prevent scratching of cylinder. Vinyl handle grips standard.

| | | |
|------------|--------------------|-------------|
| P/N | DESCRIPTION | EACH |
| HNW | Hex Nut Wrench | |



HNW

CAP WRENCH for removing caps from most cartridge operated extinguishers.

| | | |
|------------|--------------------|-------------|
| P/N | DESCRIPTION | EACH |
| CCW1 | Cap Wrench | |



CCW1

The **SLIP JOINT VALVE WRENCH** fits all manufacturers' CO₂ valves. Constructed of solid steel for a lifetime of service.

| | | |
|------------|-------------------------|-------------|
| P/N | DESCRIPTION | EACH |
| AW1 | Slip Joint Valve Wrench | |



AW1

Heavy-duty iron **PIPE WRENCHES** are cast from special steel alloy for long-lasting performance. Wrenches feature precision hardened polished jaws and teeth for a tight grip on pipe.

| | | |
|------------|-------------------------|-------------|
| P/N | DESCRIPTION | EACH |
| TL3808 | 8" Pipe Wrench | |
| TL3810 | 10" Pipe Wrench | |
| TL3814 | 14" Pipe Wrench | |
| TL3912* | 12" Offset Pipe Wrench | |
| TL3914* | 14" Offset Pipe Wrench | |
| | *WHILE QUANTITIES LAST! | |



TL3810



TL3914

Reversible ratchet **TORQUE WRENCHES** feature dial-in torque setting, permitting precise tightening to specifications. Click-stop type with 4% accuracy indicates desired torque by feel and sound. Heavy-duty cam and pawl action standard too.

| | | |
|------------|--|-------------|
| P/N | DESCRIPTION | EACH |
| TW | Torque Wrench 1/2" Drive, 10-150 ft-lb, 18" Length | |
| TW2 | Torque Wrench 3/8" Drive, 40-200 in-lb, 10" Length | |

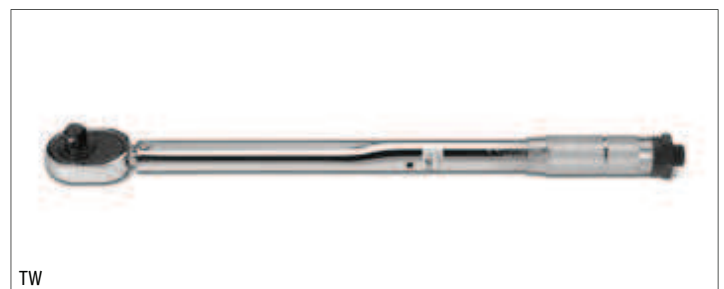

TW



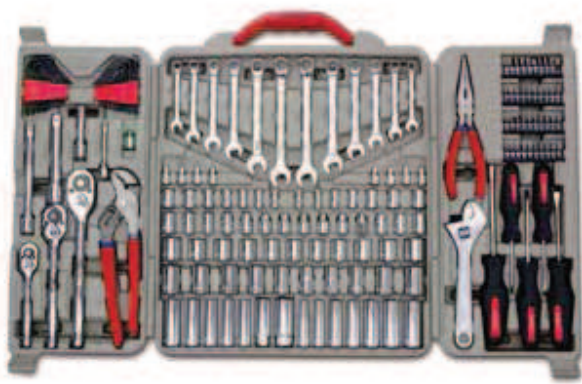

The **170-PIECE MECHANIC'S TOOL SET**, from **Crescent®**, contains a carefully selected assortment of hand tools for a wide variety of applications. Set includes 1/4", 3/8", and 1/2" quick-release ratcheting drives with numerous standard and deep sockets in the most common SAE and metric sizes. Sturdy carrying case makes tools easy to find and set to go anywhere. All tools meet stringent ANSI and ASME specifications.

| P/N | DESCRIPTION | EACH |
|---------|-------------------------------|------|
| 170PCTK | 170-Piece Mechanic's Tool Set | |

170PCTK



TL0806



TL0810

Crescent's ADJUSTABLE WRENCHES feature chrome vanadium steel construction and easy thumb adjustment.

| P/N | DESCRIPTION | EACH |
|--------|-----------------------|------|
| TL0806 | 6" Adjustable Wrench | |
| TL0810 | 10" Adjustable Wrench | |



TLAC8

Crescent's RAPIDSLIDE WRENCH features a "slide control" in the handle for fast, accurate jaw adjustment. An internal debris shield protects the slide mechanism to keep it moving freely too. It has a 1" (maximum) jaw opening capacity and a wide handle for increased leverage.

| P/N | DESCRIPTION | EACH |
|-------|----------------------|------|
| TLAC8 | 8" RapidSlide Wrench | |



TLFR28

Crescent's RAPIDRENCH has a 1/4"-7/8" adjustable jaw and can accommodate 38 different nut and bolt sizes. The jaw design extends into deep areas and the comfort grip means less hand and wrist stress.

| P/N | DESCRIPTION | EACH |
|--------|-----------------------|------|
| TLFR28 | Adjustable RapidRench | |

Crescent's TONGUE & GROOVE PLIERS feature unique teeth for increased grip and torque, precision milled ribs for a positive interlock, and alloy steel construction for years of trouble-free use.

| P/N | DESCRIPTION | EACH |
|--------|--|------|
| TL0440 | 12" Tongue & Groove Pliers | |
| TL0442 | 12" V-Jaw Tongue & Groove Pliers | |
| TL0420 | 10" Tongue & Groove Pliers | |
| TL0426 | 7" Straight Jaw Tongue & Groove Pliers | |



TL0442



TL0420



TL0426



Tools To Fit The Work You Do

WIRING TOOL features specially heat-treated blades for long life and **Channellock-Blue®** comfort grip handles.

| P/N | DESCRIPTION | EACH |
|-------|--------------------|------|
| TL908 | 8 1/4" Wiring Tool | |

Make changing links fast and easy with **LINKAGE PLIERS** from **Brooks**. No more scrunching fingers and busting knuckles trying to release cable pressure on those difficult scissor brackets. Simply place the specially curved jaws in the bracket holes and squeeze for fast, effortless link replacement. Steel construction. A must for **Ansul®** and **Amerex®** system maintenance personnel.

| P/N | DESCRIPTION | EACH |
|-------|-------------------------------------|------|
| TL915 | System Linkage Pliers (Locking) | |
| TL910 | System Linkage Pliers (Non-Locking) | |



TL915



TL910



TL908

Crescent® PLIERS feature perfectly mated cutters, heat treated to hold their edge. Made of forged alloy steel, all pliers come with non-slip cushion-grip handles for extra control and comfort.

| P/N | DESCRIPTION | EACH |
|--------|--------------------------------|------|
| TL0317 | 8" Long-Nose Pliers w/ Cutter | |
| TL0347 | 7 1/4" Linemen's Pliers | |
| TL0526 | 6 1/2" Slip Joint Pliers | |
| TL060 | 6 1/2" Long Needle-Nose Pliers | |



TL0317



TL0347



TL0526



TL060

Vise-Grip® LOCKING PLIERS can be used for turning, cutting, tightening, clamping, and twisting. They feature a hardened tooth design to grip from any angle and an adjusting screw for exact pressure and hold for repetitive use. Constructed of alloy steel and heat treated for toughness and durability. **TLVG1** and **TLVG3** feature a built-in wire cutter that cuts up to a 1/4" bolt.

| P/N | DESCRIPTION | EACH |
|-------|---|------|
| TLVG1 | 7" Curved-Jaw Vise-Grips w/ Wire Cutter | |
| TLVG2 | 7" Straight-Jaw Vise-Grips | |
| TLVG3 | 6" Long-Nose Vise-Grips w/ Wire Cutter | |



TLVG1



TLVG2

Crescent® WIRE CUTTER is made of strong alloy tool steel with hardened cutting edges. Includes non-slip cushion grips.

| P/N | DESCRIPTION | EACH |
|--------|----------------|------|
| TL0436 | 6" Wire Cutter | |



TLVG3



TL0436





General-purpose center-cut **BOLT CUTTERS** have one-piece aluminum alloy handles with rubber grips and drop-forged jaws that are heat treated for increased cutting life. **H.K. Porter®** bolt cutters also use a toggle joint that turns 50 pounds of hand pressure into 4,000 pounds of cutting power—cutting soft, medium, and hard materials easily.

NOTE: Not recommended for steel padlocks.

| P/N | DESCRIPTION | EACH |
|--------|------------------|------|
| TL1490 | 14" Bolt Cutters | |

The **CLAW/RIPPLE HAMMER**, from **Skyer®**, is manufactured tough for years of use. It features a 65% fiberglass core coated in PVC. Hammer is finished with a non-slip rubber grip. Weighs 16 oz and measures 13"L.

| P/N | DESCRIPTION | EACH |
|---------|--------------------|------|
| TL11654 | Claw/Ripple Hammer | |

TWO-POUND STAMPING HAMMER is ideal for hitting stamps and leaving a readable imprint every time. The short 8" shaft allows for easy control and the 2 lb weight makes the stamp impression readable.

| P/N | DESCRIPTION | EACH |
|-----|----------------------|------|
| SH2 | 2 lb Stamping Hammer | |



Channellock® LOCKNUT PLIERS are designed for quick, easy adjustment of electrical locknuts. Fits locknut sizes: 1/2", 3/4", 1", 1 1/4", and 1 1/2". The thin profile is ideal for use in tight wire-confined electrical boxes. Spring-loaded handles lock for easy storage. Ambidextrous.

| P/N | DESCRIPTION | EACH |
|-------|----------------|------|
| TL960 | Locknut Pliers | |



AVIATION SNIPS cut straight and wide curves. Multi-purpose design cuts sheet metal, vinyl, plastic, and rubber. Snips feature **Pro-Touch™ Grips** for comfortable handling with less fatigue. Polished alloy blades also give them a high-quality finish, while a positive lock-space safety latch keeps them closed.

| P/N | DESCRIPTION | EACH |
|-------|----------------|------|
| TL103 | Aviation Snips | |



SCREWDRIVERS, by **Crescent®**, feature tool steel construction with ergonomic handles. **TL74** and **TL106** cover all commonly used slotted screws and **TL14** and **TL24** cover all commonly used **Phillips®** head screws.

| P/N | DESCRIPTION | EACH |
|--------|---------------------------------------|------|
| TL056 | Standard 3/16" x 6" Blade Screwdriver | |
| TL074 | Standard 1/4" x 4" Blade Screwdriver | |
| TL0106 | Standard 5/16" x 6" Blade Screwdriver | |
| TL014 | Phillips 3/16" x 4" Blade Screwdriver | |
| TL024 | Phillips 1/4" x 4" Blade Screwdriver | |
| TLSP3 | Phillips 5/16" x 6" Blade Screwdriver | |



Crescent's 4-PIECE GENERAL-PURPOSE SCREWDRIVER SET features round steel shafts for strength and durability, and zinc-plating on the blade prevents corrosion. Handles feature an ergonomic design to assist with high-end torque.

| | | |
|------------|--|-------------|
| P/N | DESCRIPTION | EACH |
| TLSDS | 4-Piece Screwdriver Set Includes: 4", 6" Mechanics Round; #1, #2 Phillips | |



TLSDS

Crescent's 5-PIECE NUTDRIVER SET comes with cushioned rubber handles that are color coded for easy identification. Solid steel shafts.

| | | |
|------------|---|-------------|
| P/N | DESCRIPTION | EACH |
| TLDDS | 5-Piece Nutdriver Set Includes: 3/16", 1/4", 5/16", 11/32", 3/8" | |



TLDDS

Crescent® RATCHETING DRIVER SET features magnetic shafts with 1/4" hex drive, three torque positions (fwd/lock/rev), in-handle bit storage, and a carry case.

| | | |
|------------|---|-------------|
| P/N | DESCRIPTION | EACH |
| MBR2 | 34-Piece Dura-Driver Ratchet Driver Set Includes: 3/16", 1/4", 9/32", 5/16", 11/32", 3/8", 7/16", 5-11mm Nutdrivers; #1, #2, #3 Phillips; 1/4", 5/32", 3/16" Slotted; #1, #2, #3 Square Recess; Bit Holder w/ 1/4" Hexdrive; TX6, TX8, TX10, TX15, TX20, TX25, Torx; 1/4", 5/32", 3/16" Hex & Carry Case | |



MBR2

Eklind HEX TOOLS feature a casing that is made from a high-tech nylon resin. The hex blades are constructed of premium 8650 alloy steel, heat-treated, then black oxide-coated for rust resistance. The **Fold-Up's** unique Z-fold design allows easy access to all keys. Blades are marked with their hex size for quick identification.

| | | |
|------------|---|-------------|
| P/N | DESCRIPTION | EACH |
| HTS1 | 9-Piece Medium Fold-Up Hex Tool Set Includes: 1/20", 1/16", 5/64", 3/32", 7/64", 1/8", 9/64", 5/32", 3/16" | |
| HTS2 | 9-Piece Large Fold-Up Hex Tool Set Includes: 5/64", 3/32", 7/64", 1/8", 9/64", 5/32", 3/16", 7/32", 1/4" | |



HTS2

DRILL BITS are made of M2 high-speed steel and resist heat build-up with better penetration. Fractional-sized bits have a 118° standard point and straight shank. Ideal for metal, wood, and plastic.

| | | |
|------------|---|-------------|
| P/N | DESCRIPTION | EACH |
| DBS1 | General-Purpose Drill Bits Includes: 1/16" - 1/2" by 32nds | |



DBS1



TL2880

FLARING TOOL efficiently flares the pipe ends of seven common sizes of copper and soft aluminum tubing.

| | | |
|------------|------------------------------|-------------|
| P/N | DESCRIPTION | EACH |
| TL2880 | Flaring Tool Set, 3/16"-5/8" | |

The **89 RESCUE TOOL**, from **Channellock®**, packs a lot of functionality into a pocket-sized tool. It has a spanner wrench that works on storz and rocker lug couplings (up to 6"). There's also a tool steel punch to shatter safety glass, a pry bar for doors and windows, a gas shutoff, and hardened steel edges that easily shear through soft metal. And its narrow profile helps it work wonders in tight places.

| | | |
|------------|--------------------------------|-------------|
| P/N | DESCRIPTION | EACH |
| TL89 | 89 Rescue Tool w/ Cable Cutter | |



TL89





The **Lenox® HEAVY-DUTY HACKSAW** features lightweight all-metal construction, a large throat area for maximum cut depth, and an enlarged handle grip opening. Its unique design prevents blade from being overtensioned. Comes complete with a 12" bi-metal blade. Replacement blades are 12" x 1/2" with 24 teeth per inch (sold separately).

| P/N | DESCRIPTION | EACH |
|--------|--|------|
| TL2012 | Heavy-Duty Hacksaw | |
| TL224 | 12" x 24-Tooth Hacksaw Replacement Blade | |

Gerber's 800 Legend® MULTI-PLIER features replaceable tungsten carbide wire cutter inserts. The **Legend** has a **RemGrit®** blade, scissors, cushioned handle grips, needle-nose pliers, wire cutter, knife blade, **Phillips®** screwdriver, and small, medium, and large screwdrivers. There's a bottle opener and a file too. Tool measures 6 5/8" open, 4 1/4" closed, and weighs 9.8 ozs. Includes ballistic nylon sheath.

| P/N | DESCRIPTION | EACH |
|-------|------------------------|------|
| 8239F | 800 Legend Multi-Plier | |

The **600 Pro Scout MULTI-PLIER**, from **Gerber®**, utilizes a universal coupler with a premium **RemGrit®** blade and features flip-open needle-nose pliers. Other features include wire cutters, standard/metric scale, cross-head screwdriver, bottle and can opener, crimper, small and medium flat blade screwdrivers, file, scissors, and serrated knife. Tool measures 6 5/8" open, 5 1/8" closed, and weighs 9 ozs. Includes ballistic-nylon sheath.

| P/N | DESCRIPTION | EACH |
|-------|---------------------------|------|
| 7563F | 600 Pro Scout Multi-Plier | |

These **FOLDING KNIVES**, from **Camillus®**, are made of VG-10 Japanese steel and **Carbonitride Titanium™**. This means the knife blades will not chip, blister, peel, or flake. They're also about ten-times harder than untreated steel, which keeps the blades sharper longer. Knives come standard with G10 handles and drop point blades.

| P/N | DESCRIPTION | EACH |
|-------|--|------|
| 18670 | Carbonitride Titanium Folding Knife w/ Marlin Spike, 6 1/2" (Open) | |
| 18669 | Carbonitride Titanium Folding Knife, 6 1/2" (Open) | |
| 18668 | Carbonitride Titanium Folding Knife, 7 1/4" (Open) | |

The **E-Z-OUT™ SERRATED KNIFE**, from **Gerber®**, has a handle that features **Softgrip®** inserts for a positive, comfortable grip and easy one-handed operation. Comes with a removable stainless steel pocket clip. Weighs 2.6 ozs, is 4 9/16" closed, and 7 7/8" open.

| P/N | DESCRIPTION | EACH |
|--------|------------------------|------|
| KN6751 | E-Z-Out Serrated Knife | |

Gerber's Applegate-Fairbairn® Covert™ DOUBLE BEVEL SERRATED KNIFE features effortless one-handed operation (right or left) and includes a removable, reversible stainless steel pocket clip. The **Interlock™** system keeps the blade open or locked closed. Knife measures 3 7/8" closed, 8 7/10" open, and weighs 4.2 ozs.

| P/N | DESCRIPTION | EACH |
|--------|------------------------------------|------|
| KN5785 | Covert Double Bevel Serrated Knife | |



Retractable Or Fixed.

LABEL SCRAPERS come in either retractable or fixed versions for rapid material removal. Easy blade exchange too.

| P/N | DESCRIPTION | EACH |
|-------|---|------|
| LS105 | Label Scraper w/ Razor Blade | |
| SB109 | Razor Blades, Pkg/100 | |
| HS690 | Hood Grease Scraper, 4" Blade (9" Steel Handle) | |
| SB698 | Grease Scraper Blades for HS690, Pkg/10 | |
| HS723 | Folding Razor Scaper | |



These **UTILITY** and **SAFETY KNIVES** help prevent accidents, saving lost time at work from injuries. The **TL316** comes with three blades and a blade auto lock for extra protection from accidental cuts. The **K310** has an automatic spring-action safety guard that covers the blade, plus the chrome-plated zinc handle stores (2) extra blades.

| P/N | DESCRIPTION | EACH |
|----------|--------------------------------------|------|
| TL316 | Utility Knife | |
| TL6100RB | Replacement Blades for TL316, Pkg/10 | |
| K310 | Lewis Safety Knife | |
| LB105 | Replacement Blades for K310, Pkg/5 | |



TL316



K310

BucketBoss® HOLSTERS incorporate dense foam padding and a spring steel clip. **CPH2** fits many newer phones, including **Galaxy S3®** and all **iPhones®**.

| P/N | DESCRIPTION | H X W X D | EACH |
|--------|--------------------|----------------------|------|
| CPH | Cell Phone Holster | 6 1/2" x 2" x 1 3/4" | |
| → CPH2 | Cell Phone Holster | 6 1/2" x 3" x 1 3/4" | |



CPH



CPH2

Ergodyne's Arsenal® HOLE PUNCH HOLDER features ballistic polyester construction, stainless steel belt clip, and two pen/pencil pockets. Fits most hole punches and utility knives.

| P/N | DESCRIPTION | H X W X D | EACH |
|-----|--------------------|--------------|------|
| HPH | Hole Punch Holster | 8" x 4" x 2" | |



HPH



STU2

Zircon® Studsensor™ Pro SL-AC STUDFINDER finds joists, wood, and metal studs through drywall, plywood, paneling, and most flooring (up to 1 1/2" deep) as well as through metallic interior surfaces (up to 3/4" thick). Provides precise, instantaneous calibration; recessed LED display; and an audio signal to pinpoint stud edges. Continuously detects "hot" electrical wires (unshielded), up to 2" deep. **TruCal®** technology calibrates to any wall density.

| P/N | DESCRIPTION | EACH |
|------|----------------------|------|
| STU2 | StudSensor Pro SL-AC | |

Empire's professional-grade **POWER GRIP TAPE MEASURE** has bold, clearly printed numbers on a bright-yellow tape with fractional graduations. The rigid blade has a protective acrylic coating, plus its thick molded rubber boot fits comfortably in the hand for better control and impact absorption. Comes with a durable steel belt clip.

| P/N | DESCRIPTION | EACH |
|--------|-----------------------------------|------|
| TL125* | Power Grip Tape Measure, 1" x 25' | |

*WHILE QUANTITIES LAST!



TL125



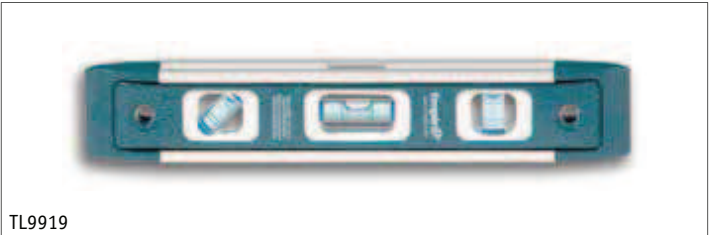

This magnetic **TORPEDO LEVEL** features a heavy-duty aluminum frame with a top-read window, V-grooved working edge for pipe work, and a powerful magnetic edge for hands-free use. Vials read plumb, level, and 45°.

| P/N | DESCRIPTION | EACH |
|--------|----------------------------|------|
| TL9919 | Magnetic Torpedo Level, 9" | |



CO₂ HOSE CONTINUITY TESTER is for testing the continuity of CO₂ hoses (per NFPA 10).
NOTE: Remove hose from extinguisher and place on a non-conductive surface before testing.

| P/N | DESCRIPTION | EACH |
|------|---|------|
| CHT | CO ₂ Hose Continuity Tester (Batteries Not Included) | |
| NCHT | CO ₂ Hose Continuity Tester (Batteries Included) | |



MISCELLANEOUS SUPPLIES AND STORAGE

Brooks' FORM HOLDER secures and organizes loose forms, invoices, work orders, etc. Swivel bar clip with writing plate makes it easy to fill out invoices and other forms.

| P/N | DESCRIPTION | EACH |
|--------|---------------------------|------|
| FH8512 | Form Holder, 8 1/2" x 12" | |



Ergodyne's Squids® TOOL LANYARD keeps tools at hand to help prevent injury and lost productivity. Lanyard is made of stretchable cord, surrounded by tubular nylon webbing with silver reflective stitching. Cord stretches for a full range of motion, 35" to 42" and has a 10 lb maximum working capacity.

| P/N | DESCRIPTION | EACH |
|---------|-------------------------------------|------|
| 19022EG | Tool Lanyard, Dual Carabiner, Black | |
| 19023EG | Tool Lanyard, Dual Carabiner, Lime | |

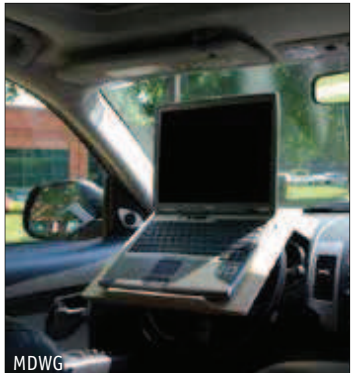

The **NOTEBOOK MOBILE DESK** is ideal for anyone who uses their vehicle as an office or just needs a comfortable writing surface in their vehicle. It installs over any 16" steering wheel in seconds. Perfect for laptops as well. Measures 15 1/4" x 13 1/4".

| P/N | DESCRIPTION | EACH |
|------|-------------|------|
| MDWG | Mobile Desk | |



The **Ergodyne® Proflex® 335HL SLIP-RESISTANT RUBBER CAP KNEE PAD** grips the work surface for stability. The 840-denier nylon fabric features 1/2" NBR foam padding and contoured side cuts for greater knee motion, and the woven elastic straps adjust for an exact fit. One size.

| P/N | DESCRIPTION | EACH |
|---------|------------------------------------|------|
| 18336EG | Slip-Resistant Rubber Cap Knee Pad | |



BUCKETBOSS® turns any empty five-gallon bucket into a tool/supply carrier. The **JB24** features 24 pleated pockets (17 outside, seven inside), leaving the center for large bulky items, like extension cords, drills, etc. The **Stacker System** comes with four compartments, drill bit sizer, pencil holder, and 4" ruler. The **Bucket Seat Pro®** combines seating and parts storage and makes a handy lid for a bucket full of tools. Tools not included.

| P/N | DESCRIPTION | EACH |
|-------|----------------|------|
| JB24 | Bucket Boss 24 | |
| BKBIN | Bucket Stacker | |
| BSEAT | Bucket Seat | |



JB24



BKBIN

The lightweight, 12-pocket **BucketBoss® TOOL BELT** was engineered to hold the most widely used repair tools. Ideal for extinguisher technicians, it holds tags, punches, seals, a rubber mallet, etc. Fully adjustable belt with quick-release buckle. One size. Tools not included.

| P/N | DESCRIPTION | EACH |
|-------|-------------|------|
| BELT1 | Tool Belt | |



BELT1

BucketBoss® GateMouth® TOOL BAGS are the leading trend in tool boxes. Padded sides protect tools, and the rigid bottom retains its shape. Features plenty of pockets inside and out. Won't scratch surfaces or rust like metal tool boxes. Large bag comes with adjustable shoulder strap. Tools not included.

| P/N | DESCRIPTION | L X H X W | EACH |
|------|----------------------|----------------|------|
| GTB2 | GateMouth Jr., Small | 13" x 8" x 10" | |
| GTB1 | GateMouth, Large | 17" x 12" x 9" | |



GTB2

BucketBoss® CONTRACTOR'S BRIEFCASE® and **PORTFOLIO** work as a mobile office. The **Contractor's Briefcase** has plenty of room for plans, file folders, notebooks, basic tools, and the **Contractor's Portfolio**, which has numerous pockets of its own. Organizers are constructed from a heavy 600-denier polyester fabric for years of service. Contents not included.

| P/N | DESCRIPTION | L X H X W | EACH |
|------|------------------------|--------------------|------|
| CBC1 | Contractor's Briefcase | 16" x 12 1/2" x 6" | |
| CBC2 | Contractor's Portfolio | 13" x 12" x 2" | |



CBC1



CBC2



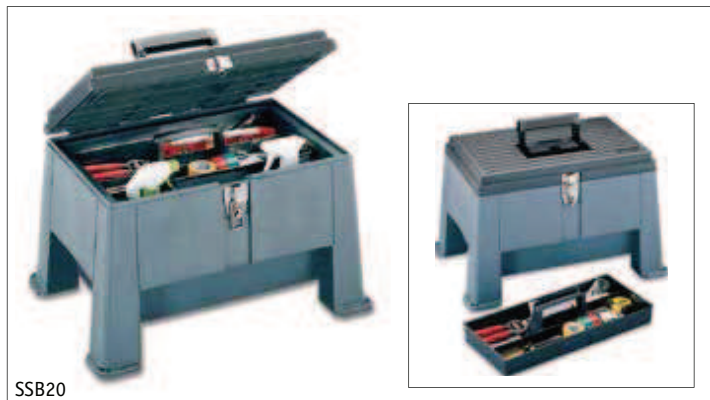

The **Step 'N Stor® TOOL BOX** is made of sturdy co-polymer that will support up to 325 lbs. Features a sure-grip large carry handle, a handy tote tray, plus a deep-bottom storage area for supplies and tools. Manufacturer's five-year warranty. Lockable.

| P/N | DESCRIPTION | H X W X D | EACH |
|-------|-----------------------|---------------------|------|
| SSB20 | Step 'N Stor Tool Box | 12 1/2" x 20" x 14" | |



SHTHS



LHTHS



HGTHM

Squids® TIE HOOKS, from **Ergodyne®** provide a versatile, innovative solution to the problem of securing and storing awkward items, like cords, cable, hoses, wires, and more. Reusable and long lasting, these tie hooks are resistant to oil, salt, solvents, and alkali. And 360° rotation of the swivel hooks offers easy access from any angle. Available in three types of attachments: **3510 Small Hook** (1" opening), **3540 Large Locking Hook** (1 1/2" opening), and **3560 Hand Grip** (1 5/8" x 3 11/16"). Hi-Vis Orange.

| P/N | DESCRIPTION | CAPACITY | EACH |
|-------|--|----------|------|
| SHTHS | Squids 3510 Small Tie Hooks, Short (11 13/16" Belt) | 22 lbs. | |
| SHTHM | Squids 3510 Small Tie Hooks, Medium (15 13/16" Belt) | 22 lbs. | |
| SHTHL | Squids 3510 Small Tie Hooks, Long (19 11/16" Belt) | 22 lbs. | |
| LHTHS | Squids 3540 Large Locking Tie Hooks, Short (11 13/16" Belt) | 44 lbs. | |
| LHTHM | Squids 3540 Large Locking Tie Hooks, Medium (15 13/16" Belt) | 44 lbs. | |
| LHTHL | Squids 3540 Large Locking Tie Hooks, Long (19 11/16" Belt) | 44 lbs. | |
| HGTHM | Squids 3560 Hand Grip Tie Hooks, Medium (15 13/16" Belt) | 44 lbs. | |
| HGTHL | Squids 3560 Hand Grip Tie Hooks, Long (19 11/16" Belt) | 44 lbs. | |



→ NEW

TRPTR1250PBMP

This **TWISTED TRUCK ROPE** features combined premium polypropylene yarns for exceptional balance and strength. Plus it's resistant to rot, mildew, oils, gas, and most chemicals. Black/Orange.

| P/N | DESCRIPTION | EACH |
|-----------------|---|------|
| → TRPTR12100PB | Medium-Duty Truck Rope (Bag), 3/8" x 100' | |
| → TRPTR1250PBMP | Medium-Duty Truck Rope (Bag), 3/8" x 50' | |



PBR1

The five-drawer **PARTS BIN RACK** stores and organizes o-rings, rivets, fusible links, etc. Bin rack and bins sold separately.

| P/N | DESCRIPTION | EACH |
|-------|--------------------------------------|------|
| PBR1 | Parts Bin Rack | |
| LPC16 | Clear Parts Bin Box, 16 Compartments | |
| LPC24 | Clear Parts Bin Box, 24 Compartments | |



The **Save-A-Load® CARGO BAR** keeps cargo in place. It has a maintenance-free pump with push-button instant release and pressure-limiting valve. Pivoting feet and ultra-gripping rubber pads enable the bar to grip any surface. Adjusts from 47" to 75". Will not rust or corrode. Manufacturer's lifetime warranty.

| P/N | DESCRIPTION | EACH |
|------|-----------------------|------|
| PUCB | Save-A-Load Cargo Bar | |



This heavy-duty **2-SHELF UTILITY CART**, from **Rubbermaid®**, features sturdy, lightweight structural-foam construction that won't rust, dent, or peel, making it ideal for any work environment. Each shelf can hold up to 250 lbs for a total capacity of 500 lbs. Ergonomically designed push handle provides optimum hand placement and push height, improving control and worker safety. Black.

| P/N | DESCRIPTION | L X H X W | EACH |
|----------|----------------------|-------------------------|------|
| 450088BK | 2-Shelf Utility Cart | 39" x 33 1/4" x 17 7/8" | |



Smazer® GENERAL-PURPOSE TRIGGER SPRAYER is a quality sprayer for general-purpose applications. Made of polyethylene, the **PLASTIC BOTTLE W/ GRADUATIONS** has dilution ratios and works perfectly with the trigger sprayer.

| P/N | DESCRIPTION | EACH |
|-------|--|------|
| SPR24 | General-Purpose Trigger Sprayer, 8 1/4" tube | |
| SPR32 | General-Purpose Trigger Sprayer, 10" tube | |
| PB24 | Plastic Bottle w/ Graduations, 24 oz | |
| PB32 | Plastic Bottle w/ Graduations, 32 oz | |



TRAINING KIT

FIRE TRAINING TORCH KIT provides an ignition and smoke source to monitor ground-level wind currents in and around raw-fuel vapor areas. Also provides a visual means for safely positioning students and instructors upwind during training exercises. Each kit includes brackets and wick and accommodates most standard automobile oil filters for burning kerosene or #2 fuel oil.

| P/N | DESCRIPTION | EACH |
|------|--|------|
| FT2 | Torch Kit | |
| FT2W | Replacement Wick | |
| FP2B | 2B-Rated Fire Pan w/ Drain Plug, 27"L x 27"W x 4"D | |





ENERGIZER ALKALINE BATTERIES

BATTERIES AND FLASHLIGHTS

Energizer® Industrial® ALKALINE BATTERIES are designed for heavy current or continuous use applications. They operate well in extreme temperatures (0°F to 130°F) with an excellent shelf life. Alkaline cells can even be used after 10 years of storage.

| P/N | DESCRIPTION | EACH |
|--------|----------------------|------|
| ALK92* | AAA Alkaline Battery | |
| ALK91* | AA Alkaline Battery | |
| ALK93 | C Alkaline Battery | |
| ALK95 | D Alkaline Battery | |
| ALK22 | 9V Alkaline Battery | |

*AAA AND AA BATTERIES MUST BE PURCHASED IN QUANTITIES OF 4.

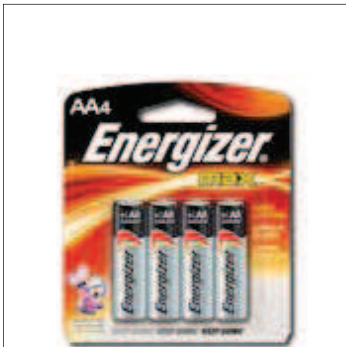

→ NEW

E91BP4



→ NEW

E93BP2

Energizer® Max® ALKALINE BATTERIES are designed for long-lasting performance in a broad spectrum of devices. They also have a long shelf life—10 years—so they're fresh when needed. And no added mercury means they can go out with the garbage.

| P/N | DESCRIPTION | EACH |
|----------|----------------------------------|------|
| → E91BP4 | Max AA Alkaline Battery, Pkg/4 | |
| → E93BP2 | Max C Alkaline Battery, Pkg/2 | |
| SL65030 | Max AAAA Alkaline Battery, Pkg/6 | |



9VLEN

Energizer® Advanced 9V LITHIUM BATTERIES are 25% lighter and have up to two-times longer storage life vs. alkaline. Operating in all temperature extremes (-40°F to 140°F), they can last up to 10 years as a backup in AC-powered smoke alarms. They also comply with ANSI 9V dimensional specs for alkaline and lithium batteries.

| P/N | DESCRIPTION | EACH |
|-------|--------------------|------|
| 9VLEN | Lithium 9V Battery | |



INCAP11EH In Use



INCAP11EH

For hands-free lighting, both indoors and out, the weatherproof and sturdy **360° LED CAP LIGHT**, from **Energizer®**, provides superior illumination for any task. Its clip attaches securely to both caps and helmets, and the unique swivel base allows 360° rotation. Provides three light modes—high and low white for general lighting or red for preserving night vision. Yellow/Black.

| P/N | DESCRIPTION | EACH |
|-----------|---------------------|------|
| INCAP11EH | 360° LED Cap Light | |
| ALK91 | AA Alkaline Battery | |



The lightweight, versatile, and comfortable **3 LED HEADLIGHT**, from **Energizer®**, is perfect for work that requires free hands. With its swivel and tilt adjustment, it puts light where you need it. Choose white flood or night-vision red for the best illumination without changing lights. Mounts securely and can be comfortably worn around the head for long periods of time. Black/Green.

| P/N | DESCRIPTION | EACH |
|--------|----------------------|------|
| HD33A1 | 3 LED Headlight | |
| ALK92 | AAA Alkaline Battery | |



HD33A1

From **Streamlight®**, the **Trident®** and **Enduro® LED HEADLAMPS** provide superior lighting, while leaving your hands free. The **Trident Headlamp** features triple LEDs, 90° tilting head, and three-way lighting for short, medium, and long distances (with spot-to-flood adjustment). The lightweight **Enduro Headlamp** features high and low lighting modes, a .5 watt high-flux LED, and o-ring sealed construction. Both headlamps are water-resistant with scratch-resistant polycarbonate bodies and come with an adjustable elastic/rubber combo head strap for maximum stability.

| P/N | DESCRIPTION | EACH |
|---------|---|------|
| SL61050 | Trident LED Headlamp, Orange/Black/Yellow | |
| SL61400 | Enduro LED Headlamp, Black/Gray | |
| ALK92 | AAA Alkaline Battery | |



SL61050

Energizer's metal **LED PENLIGHT** is small and portable, featuring a pushbutton switch for one-handed operation and a sturdy clip to help keep it close. Its super-bright LED provides strong light in an easy-to-use format too. Silver.

| P/N | DESCRIPTION | EACH |
|---------|----------------------|------|
| PLED23A | LED Pen Light | |
| ALK92 | AAA Alkaline Battery | |



SL61400

Streamlight® Stylus® PEN LIGHTS clip to your shirt pocket and produce 11 lumens of powerful white light when needed. Each pen light features a 100,000-hour LED that you can switch from constant-on to momentary blink with the click of a button. And with a knurled anodized aluminum body and pocket clip, they're easy to hang on to. They're also water-resistant and use three AAAA-cell batteries (included). Both lights are CE approved. Black.

| P/N | DESCRIPTION | EACH |
|---------|---|------|
| SL65018 | Pen Light, 6 ¹ / ₄ " Long | |
| SL65618 | Reach Pen Light, 14 ⁿ (Extended), 6 ³ / ₄ " (Folded) | |
| SL65030 | AAAA Replacement Battery, Pkg/6 | |



PLED23A



SL65618





The **Stylus Pro™ PENLIGHT** features **C4®** LED technology for blindingly bright light; compact, durable construction; optimum beam output; and a tailswitch for single-handed operation. It's also corrosion-resistant, water-resistant, shockproof, and o-ring sealed with an unbreakable lens. Comes with two AAA alkaline batteries. Black.

| P/N | DESCRIPTION | EACH |
|---------|----------------------|------|
| → 66118 | Stylus Pro Penlight | |
| ALK92 | AAA Alkaline Battery | |

→ NEW

66118



Streamlight's proprietary **Micro Optical System (MOS)** is the magic behind the blinding white light of their **MicroStream® PENLIGHT**. Its 30,000-hour high-flux LED provides up to 28 lumens. Plus it's tough, thanks to an aircraft aluminum housing with an internal polymer liner and shockproof switch. It's also o-ring sealed and comes with an unbreakable polycarbonate lens. Uses one AAA alkaline battery (included). Black.

| P/N | DESCRIPTION | EACH |
|---------|----------------------|------|
| → 66318 | MicroStream Penlight | |
| ALK92 | AAA Alkaline Battery | |

→ NEW

66318



2D INDUSTRIAL® FLASHLIGHTS, from **Energizer®**, feature a sturdy polyethylene case and a shatterproof lens to protect interior components from damage on the job. Great for general lighting needs, these flashlights come with a flip-up hook that allows hanging or belt-carrying the light easily. And the anti-roll feature helps keep the light in place when you set it down. Yellow.

| P/N | DESCRIPTION | EACH |
|---------|--------------------------|------|
| → E250Y | 2D Industrial Flashlight | |
| ALK95 | D Alkaline Battery | |

E250Y



Approved by global safety agencies, **Energizer® Intrinsically Safe® LED SAFETY FLASHLIGHTS** help eliminate risk to workers in potentially hazardous situations. These lights are waterproof, dustproof, and survive a 1-meter drop test. Comes with a shatterproof lens, easy-to-use button switch, and built-in carabiner belt clip. Class I, Division I rated. Orange.

| P/N | DESCRIPTION | EACH |
|----------|---------------------------|------|
| MS2DLED | 2D LED Safety Flashlight | |
| MS2AALED | 2AA LED Safety Flashlight | |
| ALK95 | D Alkaline Battery | |
| ALK91 | AA Alkaline Battery | |

MS2DLED



Weatherproof and water resistant, the **Energizer® Hard Case® Pro 2AA LED SWIVEL FLASHLIGHT** is an ideal choice where conditions are rugged. Four light modes make it adaptable to almost any situation—bright spot, low spot, red for night vision, and green for inspection. A flat base and swivel-head (that rotates 125°) allows for hands-free light where needed. Sturdy clip attaches to belt or strap. Black/Gray.

| P/N | DESCRIPTION | EACH |
|--------------------|--|------|
| TUFSW21PE ALK91 | Hard Case Pro 2AA LED Swivel Flashlight AA Alkaline Battery | |



TUFSW21PE



TUF4CPE

The **Energizer® Hard Case® Professional® LED SPOTLIGHT** is suited for long-distance lighting applications, thanks to its tight white spot that provides an intense focused beam. It's also weatherproof and water resistant. Pistol grip with trigger switch makes it easy to operate too. Black/Gray.

| P/N | DESCRIPTION | EACH |
|------------------|---|------|
| TUF4CPE ALK93 | Hard Case Pro LED Spotlight C Alkaline Battery | |

Designed to fit easily in a pocket or in the included belt holster, the **Energizer® Hard Case® Pro INSPECTION FLASHLIGHT** is ready to take on the toughest jobs. Durable, impact-resistant ABS plastic frames with steel sides, shock absorbing rubber overmolds, and shatterproof lenses create tool-quality lights. Powerful LEDs are designed to provide the appropriate light to accomplish the task at hand. Water-resistant. Black/Gray.

| P/N | DESCRIPTION | EACH |
|--------------------|---|------|
| TUFPL22PH ALK92 | Hard Case Pro Inspection Flashlight AAA Alkaline Battery | |



TUFPL22PH

For the toughest demands in portable lighting, the **Energizer® Hard Case® Professional® LED AREA LIGHT** features wide-angle LEDs that deliver a broad area of light. It also has two mounting options—magnet mount or solid surface mount. To operate, simply push the lens. Comes complete with three AA **Energizer Max®** batteries. Black.

| P/N | DESCRIPTION | EACH |
|----------------------|---|------|
| → TUFPAL31E ALK91 | Hard Case Pro LED Area Light AA Alkaline Battery | |



TUFPAL31E

Waypoint™ SPOTLIGHTS feature a pistol grip and trigger switch that make them easy to point and shine powerful light on an exact spot. IPX4 rated and water resistant, these spotlights have an integrated stand for hands-free lighting. They're tough, too, thanks to high-impact housings. Other features include **C4®** LEDs, unbreakable lenses, and light weight, which make the **Waypoint Spotlight** a “go-to” piece for tool box, tool belt, and more. Batteries sold separately.

| P/N | DESCRIPTION | EACH |
|---------|--|------|
| → 44900 | Waypoint Pistol Grip Spotlight w/ 12V Cord & Polymer Storage Mount, Yellow | |
| → 44902 | Waypoint Pistol Grip Spotlight w/ 12V Cord & Polymer Storage Mount, Black | |
| ALK93 | C Alkaline Battery | |



44900



Machined Aircraft Aluminum Construction



ELMCL21L

Energizer® HIGH INTENSITY LED FLASHLIGHTS are extremely dependable in extreme circumstances. Weatherproof and made of machined aluminum, these flashlights pack a lot of punch into a small package. Features include a pushbutton tail switch and a single high-intensity LED that delivers 150 lumens. They also include a slip-resistant knurled grip and a nylon lanyard for additional safety. Gunmetal Gray.

| P/N | DESCRIPTION | EACH |
|----------|--|------|
| ELMCL21L | High Intensity LED 2AA Aluminum Flashlight | |
| L91BP4 | Ultimate Lithium AA Batteries, Pkg/4 | |



NEW

SOLRE35BP

Featuring dual power sources, the **Energizer® SOLAR FOLDING LANTERN** operates on solar energy (charges even in low light) or on three D-cell alkaline batteries. What's more, in addition to solar charging. And it's flexible, folding out for 180° or 360° of bright light. Runs up to five hours (solar) or 165 hours (alkaline batteries). Orange.

| P/N | DESCRIPTION | EACH |
|-------------|-----------------------|------|
| → SOLRE35BP | Solar Folding Lantern | |
| ALK95 | D Alkaline Battery | |



SL75014

The **Stinger® FLASHLIGHT**, from **Streamlight®**, uses a 3.6V, 1.8AH battery (rechargeable up to 1,000 times) and has a xenon bi-pin bulb (11,000 candlepower). Other features include anodized aluminum housing, polycarbonate lens, and a spare xenon bulb in the tail cap. Weighs 10 oz and is 7 1/3". Over one hour of continuous use between charges. Black.

| P/N | DESCRIPTION | EACH |
|---------|-------------------------------------|------|
| SL75014 | Stinger Flashlight w/ AC/DC Charger | |
| SL75175 | Replacement Battery for SL75014 | |



SL45116

The **Litebox®** and **Vulcan® LANTERNS**, from **Streamlight®**, feature sealed-beam systems that allow easy replacement of halogen or xenon bulbs. Constructed of high-impact ABS thermoplastic with rubberized impact bumper, lens ring, and cushioned grip handle.

| P/N | DESCRIPTION | EACH |
|---------|--|------|
| SL45116 | Litebox Standard System Flashlight 11 1/2"L x 7"H x 5 1/8"W, Orange Includes: 120V AC, 12V DC Chargers; Shoulder Strap; & Mounting Rack. 8W Spot - Candlepower up to 80,000 | |
| SL45107 | Litebox Vehicle Mount System Flashlight 11 1/2"L x 7"H x 5 1/8"W, Orange Includes: Truck-Mountable, 12V DC, Direct Wire Mounting Rack & Shoulder Strap. 8W Spot - Candlepower up to 80,000 | |
| SL44000 | Vulcan Standard System Flashlight 7 1/2"L x 6 1/2"H x 5"W, Yellow Includes: 120V AC, 12V DC Chargers; Shoulder Strap; & Charging Rack. 8W Spot - Candlepower up to 80,000 | |
| SL44001 | Vulcan Vehicle Mount System Flashlight 7 1/2"L x 6 1/2"H x 5"W, Yellow Includes: Truck-Mountable, 12V DC, Direct Wire Charging Rack & Shoulder Strap. 8W Spot - Candlepower up to 80,000 | |



A

Adapters
 Battery, 132, 144
 Brass Hose, 45-46
 CO₂ Carry Handle, 219
 CO₂, Recharge, 175
 DC, Recharge, 174
 Grease Tite, 289
 Hydrotest, 179-180, 321
 I-Beam, 220
 Recharge, 175, 306
 T-Handle, 306

Addressable
 Duct Detectors, 114, 119
 Pull Stations, 115
 Smoke Detectors, 114, 119

Adhesive
 Remover, 184
 Spray On, 151, 184

Adhesive Tape
 Duct, 186
 First Aid, 91
 PTFE, 102, 184

AED
 Cabinets, 96-97
 Defibrillators, 96-97
 Replacement Parts, 98
 Signs, 87, 98, 154

Aerosols, 125, 184, 281

AFFF Foam, 58

Air
 Blow Gun, 169
 Canned, 125, 184
 Gauge, 105
 Hose, 169
 Hose Reel, 169
 Valves, 175

Alarm
 Batteries, 116, 131-132, 142-144
 Bells, 110, 123, 297
 Break Glass Cover, 122
 Covers, 122
 Guard, 110, 131
 Panels, 112-113
 Pull Stations, 115, 121
 Signs, 103-104, 151, 153

Alarms
 Cabinet, 32

Carbon Monoxide, 131
 Exit Door Lock, 141
 Exit Stopper, 141
 Fire Extg Theft Stopper, 32
 Heat, 129
 Smoke, 128-130

Alcohol Wipes, 94

Alkaline Batteries, 142, 198

Amerex
 Extinguishers, 8-16
 Pictograms, 225-233
 System Parts, 304-307

Anchors, 183

Angle Valves, 106

Ansul
 Pictograms, 234-243
 System Parts, 308-313

Antifreeze, 12, 24, 168

Antiseptics, 94

Apparel/Welding, 71

Appliance Cleaners, 281

Apron, Denim, 74

Axes, 45, 57

B

Back Supports, 64

Backpack Extg Sys, 58

Badger
 Extinguishers, 17-21
 Pictograms, 244-253
 System Parts, 314-327

Bags
 Blow-Out, 171
 Gear, Firefighters, 52
 Powder Pail, 171
 Tool, 195

Ball Valves, 109, 176

Balloons, System Test, 279

Bandages, 91

Bands, CO₂, 219

Barricade Tape, 55, 76

Batteries
 Alarm Panel, 116, 132, 144
 Alkaline, 142, 198
 BAT Series Replacement, 132, 143-144
 Eagle-Picher Replacement, 132, 143-144
 Lantern, 142

Lead Acid, 143

Lithium, 131, 142, 198

Ni-Cad, 142

Power Rite, 142-144

Pure-Lead, 143

Battery
 Adapter, 132, 144
 Analyzers, 127, 146
 Leads, 144, 147
 Tester, 126, 146

Bells, Alarm, 110, 123, 297

Bench
 Beam Scale, 174
 Vise, 170

Beverage Cylinder
 Carry Handle, 219
 Regulators, 219

Bin Boxes & Racks, 196, 207, 209

Bio Med Wash, 93

Biohazard
 Bags, 90
 Container, 90
 Kit, 90

Black Pipe
 Fittings, 293
 Nipples, 105, 292

Blankets, 65-66, 94, 96

Blow Gun, 169

Blow-Out Bag, 171

Bolt Cutters, 190

Booster Hose, 40, 56

Boots, 52, 75, 283

Box
 Document Storage, 83
 Gas Valve, 296
 Group Lock, 79
 Junction, 312
 Nipple Tote, 101, 291
 Tool, 147, 196

Brackets
 Extinguisher, 221-223
 Fusible Links, 287
 Safety-Set, 281
 Stand Off, 287, 291
 System, 304, 308, 318

Brass
 Adapters, 45-46
 Bushings, 45

Caps, 46

Fire Dept Connection, 107-108

Fittings, 45-46, 307, 317

Nipples, 42, 45, 176

Nozzles, 41-42

Plugs, 46

Reducers, 45

Valves, 47-48, 106-107, 109

Break Caps, 47

Break Glass Cover, Alarm, 122

Break Rods
 Alarm Pull, 121-122
 Ansul Remote Pull, 312

Breaker Bar & Hammer, 27, 32, 34

Briefcase/Portfolio, 195

Brushes, 102, 181

Bubble Covers, 33

Bucket Boss, 195

Buckeye Pictograms, 254-257

Bug Remedies, 94

Bulbs, 145

Burn Products, 95-96

Bursting Discs, 311, 313

Bushings, 212-213, 293-294

C

Cabinet
 Accessories, 32
 AED, 96-97
 Alarms, 32
 Covers, 27, 33
 Fire Blanket, 65-66
 Fire Extinguisher, 26-31
 Key Box/Set, 35
 Labels/Decals, 33
 Locks, 27, 30, 33-35
 Safety Storage, 81-83

CABINETS, ACCESSORIES & COVERS, 26-36

Cable
 Block, 296
 Crimps, 288
 Cutter & Crimper Tool, 288
 Fire Alarm, 127
 Stainless Steel, 288

Cages, Sprinkler, 100

Cam Lock, 35

- Canned Air, 125, 184
- Canned Smoke, 125
- Cans
 - Safety, 83-84
 - Waste, 85
- Capillary Tees, 117
- Caps
 - Blow-Off, 305, 309
 - Brass, 46
 - Break, 47
 - Cylinder, 61, 171, 213
 - Plastic, 47, 295
- Cap Light, 198
- Carbon Monoxide Alarms, 131
- Cargo Bar, 61, 197
- Cart
 - Dolly, 13, 224
 - Utility, 197
- Cartridge
 - Actuator, 314
 - Bushings, 213
 - Filling Bonnet, 212
 - Hydrotest Adapter, 180, 316
 - Nitrogen, 304, 308
 - Shipping Caps, 308
 - Smoke, 279
- Caulk, Fire-Rated, 280
- Certificate of Inspection, 303
- Chain, Double Jack, 102
- Chain Reel, 168
- Chemical
 - Antifreeze, 12, 24, 168
 - Dry Extinguisher, 24, 168
 - Foam, 58
 - Recharge, 24, 168
 - Wet, Extinguisher, 24
 - Wet, System, 304, 308
- Chrome
 - Fittings, 294
 - Sleeving, 291
- Cigarette Butt Receptacles, 85
- Circuit Breaker Lockouts, 78
- Cleaners
 - Fryer, 281
 - Grill, 281
 - Hand, 74, 93, 185
 - Multi-Surface, 184
 - Oven, 281
 - Stainless Steel Polish, 281
- Clothing
 - Apron, 74
 - Coveralls, 74, 283
 - Hood, 51
 - Rainsuit, 75
 - Suspenders, 52
- CO₂
 - Actuator Cartridges, 314
 - Bands, 219
 - Beverage Regulators, 219
 - Carry Handles, 219
 - Clips, 218
 - Cylinder Caps, 61, 171, 213
 - Extinguishers, 11, 16, 19-21
 - Filling Bonnet, 212
 - Handles, 216
 - Horns, 216
 - Hose Continuity Tester, 194
 - Hoses, 217
 - Nipples, 216
 - Recharge Equipment, 176
 - Safety Discs & Washers, 216
 - Siphon Tubes, 215
 - Straps, 218
 - Valve Pictograms, 273
 - Valve Stems, 207
 - Valves, 213-215
- Codes/Regulations, 60, 284
- Coiled Hose, 169
- Collars, VOS, 164
- Concrete Anchors, 183
- Condemned Tag, 165
- Conductivity Test Label, 160
- Conduit Fittings, 287, 310
- Conduit, Flexible, 310, 320
- Contactors, Electrical, 297
- Continuity Tester, 194
- Control Heads, 304, 308, 318
- Control Modules, Fire Alarm, 115
- Control Panels, Fire Alarm, 112-113
- Copper Tubing, 307, 317, 323
- Corner Pulleys, 289-290, 305, 309
- Coveralls, 74, 283
- Covers
 - Alarm, 122
 - Boot/Shoe, 71, 74, 283
- Bubble, 33
- Cabinet, 27, 33
- Drum, 85
- Extinguisher, 36
- Fire Hydrant, 36
- Rack & Reel, 44
- Tag, 166
- Vinyl, 36, 44
- Wheel Unit, 36
- CPR/Biohazard Supplies, 90
- Crimps & Crimping Tools, 288
- Custom Sign Order Form, 157
- Custom Signs, 156
- Cylinder
 - Cap, 61, 171, 213
 - Dryer, 177
 - Inspection Lights, 178
 - Inspection Mirrors, 178, 181
 - Lockers, 84
 - Rack System, 61
 - Stamp Sets, 180
 - Tag, 165
 - Test Labels, 161
- Cylinders, 304, 308, 314, 318
- D**
 - DACT, 113
 - Danger Signs, 153
 - Decals, 33, 118
 - Defibrillators, 96-97
 - Defibrillator Replacement Parts, 98
 - Detector Assembly, 305
 - Detectors
 - Addressable, 114
 - Carbon Monoxide, 119
 - Duct, 114, 119
 - Heat, 120, 286
 - Leak, 182
 - Smoke, 114-116, 119
 - System, 305, 309, 315, 319
 - Tester, 124, 184
 - Waterflow, 109, 120
 - Discs, Burst, 311, 313
 - Dispenser, Barricade Tape, 55, 76
 - Dispenser, Wipes, 74, 185, 282
 - Dispensing Bottle, 85
 - Disposable Gloves, 73, 93
- Document Storage Box, 83, 127
- Dolly Cart, 13, 224
- Door(s)
 - Duct Access, 280
 - Holder, Fire, 122
 - Lock, Exit, 141
 - Pouch, 61
- DOT
 - Labels, 159-160
 - Stamps, 180
 - Supplies, 61
- Double Jack Chain, 102
- Drill
 - Bits, 191, 298-299
 - Vari Bit Step, 299
- Drum
 - Covers, 85
 - Funnel, 85
 - Wrench, 85
- Dry Chemical
 - Extinguishers, 8-9, 11, 18, 21
 - Gauges, 204
 - Powder, 24, 168
 - Recharge Kit, 174
 - Valve Stems, 205-206
 - Wheeled Unit Hose, 217
- Dryer, Cylinder, 177
- Dual Gauge Assembly, 178
- Duct
 - Access Doors, 280
 - Detector Test Tool, 126
 - Smoke Detectors, 114, 119
 - Tape, 186
- Dust Mask, 72, 171
- E**
 - Ear Plugs & Muffs, 72
 - Eductors, Foam, 58
 - Electric Hose Tester, 41
 - Electrical Contactors, 297
 - Electrical Tape, 186
 - Electrical Tester, 146
 - Electronic Digital Scale, 173
 - Emergency
 - Blanket, 65-66, 94-95
 - CPR/Fluid Barrier Kit, 90
 - Exit Signs, 134-137, 152, 154
 - Fluorescent Pack, 140

- Light Cross Reference Guide, 148
- Light Test Button Pick, 146
- Lights, 136-141
- Preparedness Kits, 66
- Response Guidebook, 60
- EMERGENCY RESPONSE PRODUCTS, 50-58
- Epoxy, 161
- Escutcheons, 101, 108-109
- Exit
- Door Lock, 141
 - Signs, 134-137, 152, 154
 - Stopper, 141
- EXIT & EMERGENCY LIGHTING, 134-148
- Expansion Rings, 40
- Extinguisher
- Alarms, 32
 - Cabinets/Covers, 26-31, 33
 - Parts, 276
 - Stands, 29, 224
 - Vinyl Covers, 36
- Extinguishers, 8-22
- Eye Care Products, 70, 95
- Eye Protection, 51, 68-69
- Eyewash, 70, 95
- Eyewear Lanyard, 70
- E-Z Anchors & Toggles, 183
- E-Z Fill Siphon, 169, 302, 306, 311, 321
- F**
- Face Shields, 67
- Fall Protection, 77
- Fasteners
- Anchors, 183-184
 - Quick Mount, 299
 - Tag, 166
- Fiberglass Cabinets, 28
- Fill Systems, DC, 171
- Filling Bonnet, 212
- Filter
- Hood, 278
 - Grease, 278
 - Spacers, 279
- Finger Guards, 93
- Fire
- Alarms Cables, 127
 - Alarms, 112-115, 119-123, 128-131
 - Axes, 45, 57
 - Blankets, 65-66, 94, 96
 - Boots, 52
 - Dep't Connections, 107-108
 - Dep't Fittings, 45-47
 - Dep't Foam, 58
 - Dep't Lockbox, 35
 - Dep't Nozzles, 58
 - Dep't Tools, 44-45, 56-57
 - Document Box, 127
 - Door Holders, 122
 - Extinguisher Brackets, 221-223
 - Extinguisher Chemical, 24, 168
 - Extinguisher Parts, 276
 - Extinguisher Signs, 12, 34, 150-151
 - Extinguisher Stands, 29, 224
 - Extinguishers, 8-22
 - Gloves, 50
 - Helmets, 51
 - Hood, 51
 - Hose, 38-40, 55-56
 - Hose Couplings, 40
 - Hose Covers, 44
 - Hose Fittings, 42, 45-47
 - Hose Nozzles, 41-42, 58
 - Hose Racks, 42-43
 - Hose Reels, 43
 - Hose Signs, 153
 - Hose Testing Equipment, 41, 56, 177
 - Hose Tote Straps, 40, 56
 - Hose Valves, 47-48, 57, 106-107
 - Retardant, 65
 - Training Torch Kit, 197
- FIRE ALARM PRODUCTS, 112-132
- FIRE EXTINGUISHER PARTS, 204-276
- FIRE EXTINGUISHERS & CHEMICAL, 8-24
- FIRE HOSE, NOZZLES, BRASS, & HOSE VALVES, 38-48
- Fireboy
- Accessories, 23
 - Extinguishers, 22
- First Aid
- Cabinets, 86
 - Cream/Ointments, 94
 - Eyewash, 70, 95
 - Gauze, 91
 - Gloves, 73, 93, 98
 - Hot Packs, 94
 - Ice Packs, 94
 - Instruments, 94
 - Kits, 87-89
 - Medications, 92
 - Signs, 70, 87, 95, 98, 154
 - Supplies, 70, 86-98
 - Tape, 91
 - Wash, 93
 - Wipes, 93
 - Wraps, 91
- Fittings
- Black Pipe, 293
 - Brass, 45-46, 307, 317
 - Chrome Pipe, 294
 - Conduit, 287
 - EMT, 289
 - Flare, 300, 307, 317
 - Tote Tray, 101, 294
- Flag Pictograms, 258-259
- Flag Seals, 210-211
- Flame Retardant, 65
- Flame-Safe Caulk, 280
- Flame Simulator, 126
- Flare Container, 63
- Flares, 63
- Flaring Tool, 191, 300, 307
- Flashlights, 52-55, 200-202
- Flexible Conduit, 310, 320
- Florida Truss Signs, 158
- Foam
- AFFF, 58
 - Eductors, 58
 - Extinguisher, 13, 19
 - FFFP, 12, 16
 - Nozzle, 58
- Foam Adhesive Tape, 102
- Fog Nozzles, 41-42, 58
- Forestry Hose, 40, 56
- Form(s)
- Holder, 61, 63, 83, 194, 303
 - Inspection, 61, 303
- Fryer Panel, 278
- Funnels, 84, 85, 169
- Fusible
- Link Brackets, 287
 - Link Hangers, 319
 - Links, 284-286
- G**
- Gas
- Labels, 160
 - Valves, 295, 306, 310, 315, 320
 - Valve Box, 296
 - Valve Kit, 296
- Gate Valves, 48, 57, 107
- Gated Wye, 47, 57
- Gauge(s)
- Cap, 56
 - Certified Test, 178
 - Clean Agent, 204
 - Dry Chemical, 204
 - Dual Assembly, 178
 - Inline, 56
 - Pitot, 56
 - Recharge, 170
 - Regulator, 219
 - Sprinkler, 105
 - Tester, Water Extg, 182
 - Valve, Three-Way, 105, 172
 - Water-Based Extinguisher, 204
 - Wrench, 182, 204
- Gauze, 91
- Gear Bag, Firefighter's, 52
- General Pictograms, 260
- Glasses, Safety, 68-69
- Gloves
- Fire, 50
 - First Aid, 73, 93
 - Latex, 73, 93
 - Neoprene, 283
 - Nitrile, 73, 93, 98
 - Welding, 71
 - Work, 73
- Glow-In-The-Dark
- Lightsticks, 63
 - Signs, 87, 135, 154

- Goggles, 51, 69, 283
- Grease
 - Comb, 281
 - Filters, 278
 - Scraper, 301
 - Silicone, 209, 313
- Guards
 - Alarm Bell, 110, 123, 297
 - Cylinder Valve, 61
 - Exit Light, 140
 - Exit Sign, 140
 - Finger, 93
 - Hood Light, 279
 - Pull Station, 302
 - Smoke Alarm, 131
 - Sprinkler Head, 100
- H**
- Hacksaw, 192
- Halon
 - Extinguishers, 10
 - Gauges, 204
 - Valve Stems, 206-207
- Halotron Extinguishers, 10, 15, 19
- Hammers, 181, 190
- Hand
 - Cleaners, 74, 93, 185
 - Sanitizer, 74, 93
 - Soap, 185
 - Wipes, 74, 93, 185
- Handles
 - CO₂ Carry, 219
 - Grip, Valve, 176
 - Rubber CO₂, 216-217
- Handwheels, 48, 107
- Hanger Loop Kit, 223
- Hanger(s)
 - Fusible Link, 319
 - Hose, 43
 - Wall, 220-221
- Hanging Scales, 173
- Hard Hats, 67
- Harness, 77
- Hazard Signs, 160
- Head Protection, 67
- Headlamps, 54, 199
- Headlights, 54, 199
- Hearing Impaired Smoke Alarm, 130
- Hearing Protection, 72
- Heat
 - Alarm, 129
 - Detector Tester, 124
 - Detectors, 120, 286
- Height Indicator, 154
- Helmets
 - Firefighting, 51
 - Hard Hats, 67
- Hex Tools, 187, 191
- Hole
 - Cutters, 298
 - Punches, 168
 - Punch Holder, 193
 - Saws, 299
- Holsters, 193
- Hood
 - Adapters, Grease Tite, 289
 - Caulks, 280
 - Duct Access Doors, 280
 - Filters, 278
 - Grease Scraper, 301
 - Installation Tool, 299
 - Light, 279
 - Nomex Firefighting, 51
 - Patch Seals, 289
 - Signs, 303
- Horn(s)
 - CO₂, 216
 - Holder, 217
- Hose
 - Air, 169
 - Booster, 40, 56
 - Clip, 218
 - CO₂, 217
 - Continuity Tester, CO₂, 194
 - Couplings, 40
 - Covers, 44
 - Electric Tester, 41
 - Fire, 38-40, 55-56
 - Gaskets, 40
 - Hanger, 43
 - Hook, 44, 56
 - Hump Rack, 43
 - Nitrogen, 172
 - Nozzles, 41-42, 58
 - Racks, Pin, 42
- Reels, 43, 169
- Rings, 40
- Strap, 218
- Tote Strap System, 40, 56
- Valves, 47-48, 57, 106
- Hot Packs, 94
- Hump Racks, 43
- Hydrant
 - Cover, 36
 - Flow Test Kit, 56
 - Valves, 47-48, 57, 105-107
 - Wrenches, 44, 57
- Hydrotest
 - Adapters, 179-180
 - Labels, 161
 - Pump, 177
- I**
- Ice Packs, 94
- Industrial Mat, 81, 282
- Infrared Laser Thermometer, 284
- Insect Sting Itch Relief, 92
- Inspection
 - Certificate, 303
 - Forms, System, 303
 - Lights, 178, 201
 - Mirrors, 178, 181
 - Tags, 165-166
 - Vehicle Report, 61
- K**
- Key Box/Set, 35
- Key Chain Reel, 168
- Kidde
 - Pictograms, 261-270
 - System Parts, 314-317
- Kits
 - Bloodborne Pathogen, 90
 - Bodily Fluid Clean-Up, 90
 - Burn, 96
 - Connector, 118
 - CPR & Fluid Barrier, 90
 - Detector Kit, 309
 - Discharge Adaptor, 304
 - Dry Chemical Refill, 174
 - Emergency Preparedness, 66
 - Fire Training Torch, 197
 - First Aid, 87-89
- Gas Valve, 296, 306
- Hanger Loop, 223
- Hydrotest Adapter, 179
- LED Retrofit, 145
- Link Housing Adapter, 287
- Number, 158
- O-Ring Removal, 181
- O-Rings, 209
- Paintball Cylinder Recharge, 176
- Recharge Adapter, 174
- Rivet, 209
- Service Truck, 171
- Snake Bite, 89
- Stamp, 162
- Start-Up, 174
- Triangle Kit, 62
- Universal Gas Valve, 296
- Valve Stem, 207
- Wheeled Unit, 174
- Knee Pad, 194
- Knives, 192-193
- L**
- Labels
 - Agent Replacement, 164
 - Call For Service, 164
 - Composite Retest, 161
 - Conductivity Test, 160
 - DOT, 159-160
 - Extinguisher Operating, 158-159
 - Hazmat, 160
 - Hydrotest/Maintenance, 161
 - Installation, 163
 - Lighting Service, 147
 - Service, 163
 - Sprinkler, 104, 110
 - Sprinkler Gauge, 105
 - Temperature, 286
- Ladder
 - Escape, 65
 - Step, 196
- Lanyards, 70, 77
- Laser Thermometer, 284
- Leak Detector, 182
- LED Bulbs, 145
- Lens Cleaning Station, 70
- Level, 194, 301

- Life Vest, 64
 - Light(s)
 - Cylinder Inspection, 178
 - Emergency, 136-141
 - Exit, 134-137
 - Flashlights, 52-55, 200-202
 - Headlamps, 54, 198-199
 - Headlights, 54
 - Hood Fixture, 279
 - Lanterns, 202
 - LED Area, 201
 - Pen, 54, 178, 199-200
 - Spot, 201
 - Sticks, 63
 - Strobe, 110, 123, 130, 297
 - Line Tester, 106
 - Linkage Pliers, 189, 301
 - Link(s)
 - Brackets, 287
 - Fusible, 284-286
 - Hanger, 319
 - Housing Adapter Kit, 287
 - Resettable, 284
 - Test, 285
 - Thermal, 284
 - Lithium Batteries, 131, 142, 198
 - Lock Box, 35, 79
 - Lock Pins & Chains, 212
 - Lockers, Cylinder, 84
 - Locknut Pliers, 190, 296, 302
 - Lockout/Tagout, 77-79
 - Locks, 33-35, 79-80
 - Lubricant, 184, 209, 298
- M**
- Magnetic Strip, 34, 102
 - Mallet, Rubber, 171
 - Marine Systems, 22-23
 - Marking
 - Pens, 182
 - Tape, 76
 - Mask, Dust, 72, 171
 - Mats
 - Floor Safety, 81, 282
 - System Service, 301
 - Measuring
 - Tape, 193
 - Wheels, 62
 - Medicated Sprays, 94
 - Medications, 92
 - Megaphones, 64
 - Metal Stamps, 180
 - Microswitches, 305, 309, 315, 319, 323
 - Mirrors, Inspection, 178, 181
 - Mobile Desk, 63, 194
 - Monitor/Control Modules, 115
 - Multi-Meter, 125, 146
 - Multi-Pliers, 192
 - Municipal
 - Boots, 52
 - Foam, 58
 - Gear, 50-52
 - Gloves, 50
 - Hose, 55-56
 - Lighting, 52-55
 - Nozzles, 58
 - Tools, 56-57
 - Valves, 57
- N**
- NFPA Publications, 60, 284
 - Ni-Cad Batteries, 142
 - Nipples
 - Brass, 42, 45, 176
 - Pipe, 105, 292
 - Rack, 42
 - Tote Box, 101, 291
 - Nitrogen Cartridges, 304, 308
 - Nitrogen Regulator, 172
 - Nitrogen Valves, 215
 - Non-Compliance Tag, 165
 - Notification Appliances, 123
 - Nozzle(s)
 - Aiming Device, 313
 - Caps, 305, 309, 315, 319, 321
 - Fire Hose, 41-42, 58
 - Systems, 305, 309
 - Number Kit, 158
 - Nutdriver Set, 191
- O**
- Oil, Thread Cutting, 300
 - Ointments, 94
 - O-Ring(s)
 - Extinguisher, 208
 - Kit, 209
 - Lubricant, 209
 - Removal Kit, 181
 - Operating Labels, 158-159
 - Oven Cleaners, 281
- P**
- Padlocks, 33-34, 80
 - Pail Opener, 170
 - Paintball Cylinder Recharge Kit, 176wParticulate
 - Respirator, 72
 - Parts Bin Rack, 196, 209
 - Patch Seals, 289
 - Pemall Pictograms, 271
 - Pen(s)
 - Ball Point, 182
 - Lights, 54, 178, 199-200
 - Marking, 182
 - Pepper Spray, 64
 - PERSONAL PROTECTION & SAFETY PRODUCTS, 60-98
 - Photo-Luminescent
 - Exit Signs, 135
 - Tape, 135
 - Pictograms, Miscellaneous, 277
 - Pin Racks, 42
 - Pipe
 - CPVC, 117
 - Cutters, 117
 - Dope Brush, 102, 181
 - Fittings, 293
 - Nipples, 105, 292
 - Sleeving, Chrome, 291
 - Thread Sealant, 102
 - Threading Machine, 300
 - VESDA, 117
 - Wrenches, 300
 - Pitot Gauge, 56
 - Placard, DOT, 61
 - Plastic Bottle, 197
 - Plastic Sheeting, 283
 - Plates, Escutcheons, 108-109
 - Playpipe, 41
 - Pliers, 188-190, 296, 301, 306
 - Plugs
 - Black Pipe, 293
 - Brass, 46
 - Chrome, 294
 - Lockout, 79
 - Pneumatic Piston, 295, 313
 - Polycarbonate Nozzles, 41
 - Poncho, Rain, 75
 - Powder Pail Bags, 171
 - Power Supplies, 116, 127
 - Pressure Switches, 109, 120
 - Protective Boot/Shoe Covers, 71, 74, 283
 - Protective Coveralls, 74, 283
 - PTFE Tape, 102, 184
 - Publications
 - CFR, 60
 - Compliance Guide, 60
 - Emerg Resp Guide, 60
 - Fed Motor Carrier, 60
 - NFPA, 60, 284
 - Pull Pins, 212
 - Pull Station
 - Alarm, 115, 121
 - Guards/Protectors, 122, 302
 - Manual, 121, 306
 - Pull Tabs, 310
 - Remote, 310
 - System, 306, 310, 316, 320
 - PVC Boots, 75, 283
 - Pyro-Chem Sys Parts, 318-323
- Q**
- Quad Rings, 208
 - Quick Disconnect
 - Couplers, 175, 179
 - Quick Mount Fasteners, 299
 - Quick Seals, 289
- R**
- Rack
 - Covers, 44
 - Cylinder Drying, 177
 - Hump, 43
 - Nipples, 42
 - Parts Bin, 196, 209
 - Pin, 42
 - System, Cylinder, 61
 - Wall Brackets, 43
 - Rainwear, 75
 - Range Guard Sys Parts, 314-317
 - Recharge
 - Adapters, 175
 - Antifreeze, 12, 24, 168

Chemical, 12, 19, 24, 168
 Equipment, 170-172, 176
 Foam, 13, 19, 24, 168
 Gauges, 172
 Recovery Unit, 170
 Wet Chemical, 12, 20, 24,
 168, 304
 Reducers, Brass, 45
 Reel Covers, 44
 Reels, 43, 169
 Reflector Triangle Kit, 62
 Regulator
 Beverage, 219
 Nitrogen, 172
 System, 311
 Test Kit, 313
 Remote Heads, 17, 137, 141
 Remote Pull Station, 310
 Remote Test Station, 114
 Repair Tag, 165
 Report Holder, 61, 63, 83, 303
 Rescue Tools, 44-45, 57, 191
 Reset Relay, 297
 Respiratory Protection, 72, 171
 Retardant, Fire, 65
 Rivets, 209
 Rubber Mallet, 171

S

S-Hooks, 288
 Safes, 81
 Safety
 Cabinets, 81-82
 Cans, 83-85
 Discs & Washers, 216
 Flare Container, 63
 Flares, 63
 Glasses, 68-69
 Goggles, 51, 69, 283
 Knives, 193
 Lockers, 84
 Mats, 81, 282
 Self-Defense Spray, 64
 Set Brackets, 281
 Supports, 64
 Training Posters, 153
 Vests, 50, 76
 Whistle, 64
 Scales, 172-174

Scoops, 170
 Scrapers, 193, 301
 Screwdrivers, 190-191
 Seals
 Patch, 289
 Tamper, 105, 210-211
 Self-Defense Spray, 64
 Self-Luminous Exit Signs, 135
 SERVICE EQUIPMENT,
 168-202
 Service Manuals, 306, 311, 316,
 321
 Sherwood Pictograms, 274
 Shipping Caps, 61, 213
 Shipping Document, DOT, 61
 Shop Towels, 74, 185, 282
 Siamese Connections, 107-108
 Sign On Adhesive, 151, 184
 Signs 12, 34, 70, 87, 95, 98,
 103-104, 108, 134-137,
 150-155, 158, 303
 SIGNS, LABELS & TAGS,
 150-166
 Silicone Grease, 209, 313
 Single Jacket Fire Hose, 38
 Siphon Tubes, 169, 215
 Sleeving, Chrome, 291
 Six-Year Maintenance Labels,
 161
 Smoke
 Alarm Guard, 131
 Alarm Tester, 124-125, 184
 Alarms, 128-130
 Cartridges, 279
 Detector Tester, 124-125, 184
 Detectors, 114-116, 119
 Snake Bite Kit, 89
 SnapToggle Anchors, 183
 Soap, Hand, 185
 Solar Folding Lantern, 202
 Solvent Cement, 117
 Sound Level Meter, 123, 126
 Spanner Wrenches, 44, 57
 Spotlights, 201
 Sprayers, 197
 Sprays
 Medicated, 94
 Self Defense, 64
 Spring Clip Brackets, 222

Sprinkler
 Accessories, 109-110
 Cabinet, Head, 101
 Cages, 100
 Escutcheons, 101, 108-109
 Gauge Valve Kit, 105
 Gauges, 105
 Heads, 100
 Installation Label, 105
 Line Label, 104
 Service Tags & Labels, 110
 Shut-Off, 102
 Signs, Identification,
 103-104, 108, 155
 Supervisory Switch, 110, 120
 Tamper Seal, 105
 Wrenches, 102

SPRINKLER ACCESSORIES &
 STANDPIPE EQUIPMENT,
 100-110
 Stainless Steel Cable, 288
 Stamp
 DOT Identification, 180
 Holder, 180
 Kit, 162
 Number Set, 180
 Stamping Hammer, 181, 190
 Standpipe Escutcheons,
 108-109
 Start-Up Kit, Service, 174
 Steel Enclosures, 297
 Steel Stamps, 180
 Steel Tanks, 308
 Steel Toe Boots, 75, 283
 Storage
 Cabinets, 81-83
 Document Box, 83
 Straight Stream Nozzle, 41
 Strapping Tape, 146
 Strike First Pictograms, 272
 Strobe Light, 110, 123, 130, 297
 StudSensor, 193
 Superior Pictograms, 275
 Supervisory Switch, 110, 120
 Supports
 Back, 64
 Wrist, 64
 Suspenders, H-Back, 52

System
 Brackets, 304, 308, 318
 Enclosures, 304, 308, 318
 Detectors, 305, 309, 315, 319
 Hole Cutting, 298
 Inspection Certificate, 303
 Inspection Form, 303
 Pull Stations, 306, 310, 316,
 320
 Service Mat, 301
 Service Tools, 306, 311, 316,
 321
 Signs, 155
 Smoke Cartridges, 279
 Test Balloons, 279
 SYSTEM PARTS, 278-323

T

Tag Covers, 166
 Tag Fasteners, 166
 Tags, 79, 110, 162-163, 165-166
 Tamper Seals, 105, 210-211
 Tape
 Adhesive, 91, 184
 Aisle Marking, 76
 Barricade, 55, 76
 Dispenser, 55, 76
 Double-Sided Foam, 102
 Duct, 186
 Electrical, 186
 Glass Strapping, 146
 Gun, 186
 Magnetic, 34, 102
 Measure, 193
 Packing, 186
 PTFE, 102, 184
 Warning, 55, 76
 Tee Pulley, 290, 305, 309
 Telescopic Match Extender, 301
 Temperature Labels, 286
 Test Balloons, 279
 Test Cage, 177
 Test & Drain Valves, 106
 Test Equipment, Hydraulic, 56
 Test Gauge, Certified, 178
 Test Link, 285
 Test Pump, 177

- Tester
- Battery, 126, 146
 - Continuity, 194
 - Electric, Hose, 41
 - Gauge, 182
 - Heat Detector, 124
 - Line, 106
 - Smoke Alarm/Detector, 124-125, 184
- Thermometer, Infrared Laser, 284
- Thread
- Cutting Oil, 300
 - Pipe Machine, 300
 - Sealant, 102
- Tie Hooks, 196
- Toggle Bolts, 183-184
- Tool(s)
- Aviation Snips, 190
 - Axes, 45, 57
 - Bags & Belts, 195
 - Bolt Cutters, 190
 - Box, 147, 196
 - Brushes, 102, 181
 - Bushing, 212
 - Core Removing, 175
 - Drill Bits, 191, 298-299
 - Flaring, 191, 300, 307
 - Hacksaw, 192
 - Hammers, 181, 190
 - Holder, 181
 - Hole Saw, 299
 - Knives, 192-193
 - Lanyard, 194
 - Mallet, Rubber, 171
 - Multi-Pliers, 192
 - Nutdrivers, 191
 - Pipe Threading Machine, 300
 - Pliers, 188-189, 190, 192, 296, 302, 306
 - Rescue, 44-45, 57, 191
 - Screwdrivers, 190-191
 - Sets, 188, 191
 - System Service, 306, 311, 316, 321
 - Torpedo Level, 194, 301
 - Wiring, 147, 189
 - Wrenches, 44, 57, 85, 102, 182, 187-188, 288, 300
- Tourniquet, 92
- Towels, Shop, 74, 185, 282
- Traffic
- Cones, 62
 - Lightsticks, 63
 - Safety Flares, 63
 - Triangle Kit, 62
 - Vests, 50, 76
- Training Torch Kit, 197
- Transfer Cans, 83-84
- Triangle Kit, 62
- Trigger Sprayers, 197
- Truck Rope, 196
- Truss Signs, 158
- Tubes, Siphon, 169, 215
- Tubing, Copper, Polyethylene, 118, 307, 317, 323
- Tubing Cutter, 291, 300, 307
- U**
- Unitized, First Aid, 87-89
- Utility
- Cart, 197
 - Knives, 193
 - Scale, 173
- V**
- Vacu-Fill Parts, 170
- Vacu-Fill Recovery Sys, 170
- Valve Stems, 205-207
- Valve(s)
- 3-Way, 105, 172
 - Air, 175
 - Angle, 47-48, 106
 - Ball, 109, 176
 - CO₂, 213-215
 - Flip, 177
 - Gas, 295, 306, 310, 315, 320
 - Gate, 48, 57, 107
 - Gated Wye, 47, 57
 - Globe, 106
 - Guard & Cap, 61, 171
 - Handle Grip, 176
 - Handwheels, 48, 107
 - Hose, 47-48, 57, 106
 - Hydrant, 47-48, 57, 105-107
 - Lockouts, 77-78
 - Municipal, 57
 - Nitrogen, 215
- Quick Release, 214
- Replacement Parts, 48, 107
- Test & Drain, 106
- Wheeled Unit, 214
- Vehicle Brackets, 221-223
- Vehicle Inspection Report, 61
- Verification of Svc Collars, 164
- VESDA
- Aspirator, 116
 - Capillary Tees, 117
 - Decals, 118
 - Detector, 116
 - Expansion Card, 116
 - Filter, 116
 - Imager, 115
 - Pipe, 117
 - Pipe Cutters, 117
 - Power Supply, 116
 - Solvent Cement, 117
- Vests
- Life, 64
 - Traffic, 50, 76
- Vinyl Covers, 36, 44
- Vise, Bench, 170
- Voltage Tester, 146
- W**
- Wall Anchors, 183
- Wall Bracket, Pin Rack, 42
- Wall Hooks, 220-221
- Warning Tape, 55, 76
- Washers, 184, 216
- Waste Can, 85
- Water
- Extinguishers, 12, 20
 - Gauges, 105, 204
- Waterflow Detectors, 109, 120
- Water-Jel Burn Products, 95-96
- Weights, Class 7, 173
- Welding Apparel, 71
- Welding Gloves, 71
- Wet Chemical
- Charges, 12, 20, 24, 168
- Wet System Parts
- Amerex, 304-307
 - Ansul, 308-313
 - Badger, 314-317
 - Kidde, 314-317
- PyroChem, 318-323
- Range Guard, 314-317
- Wheel Chock, 62
- Wheeled
- CO₂ Unit Horn Ass'y, 217
 - CO₂ Unit Hose, 217
 - Unit Covers, 36
 - Unit Service Kit, 174
 - Unit Valves, 214
 - Units, 13-16, 21
- Whistle, Safety, 64
- Wildland Backpack
- Extinguishing System, 58
- Wipes, 74, 93, 185, 282
- Wire
- Brush, 181
 - Connectors, 147
 - Cutter, 147, 189
 - Tools, 147, 189
- Wraps, First Aid, 91
- Wrenches
- Adjustable, 188
 - Cap, 187
 - Drum, 85
 - Gauge, 182, 204
 - Hex Nut, 187
 - Hydrant, 44, 57
 - Jiffy, 288
 - Pipe, 187, 300
 - Ratcheting, 288
 - Slip Joint, 187
 - Spanner, 44, 57
 - Sprinkler, 102
 - Storz, 44, 57
 - Torque, 187, 213
- Wrist Support, 64