



TEL: 800.BRADLEY
FAX: 262.251.5817
bradleycorp.com

Washroom Accessories List Price Book 0217WAP

Effective Date February 1, 2017

Table of Contents

Introduction	2
Diplomat	3, 4
Multi-Purpose Units	5
Towel-Waste Units	6, 7
Towel Dispensers	8
Hand Dryers	9
Waste Receptacles	10
Napkin/Tampon Vendors & Disposals	11
Toilet Tissue Holders	12, 13
Soap Dispensers	14
Mirrors	15 - 17
Shelves	18
Grab Bars (How to Specify, Configurations, Grab Bars)	19 - 31
Hospitality	32 - 35
Healthcare, Shower Seats, Medicine Cabinets, Custodial Accessories	36, 37
Security Accessories	38



Washroom Accessories Division

TEL: 1-800-BRADLEY FAX: 262-251-5817

Web Site: www.bradleycorp.com

Effective Date February 1, 2017

Introduction

PRICES	This price list applies from its effective date. All prior price lists are canceled. Prices are subject to change without notice. Items may be changed or discontinued without notice and without incurring obligation. For job quotations, please contact your Bradley Sales Representative .
CREDIT TERMS	Open account terms are Net within 30 days from date of invoice. Past due accounts may be subject to a service charge. Settlement of past due invoices may be required before additional shipments are made. Cash in advance may be required when an open account is not approved. Our Credit Department phone is 1-800-BRADLEY, FAX (262) 251-7747.
MINIMUM ORDERS	Orders under \$50.00 Net will incur a \$10.00 service charge.
RETURN MERCHANDISE AUTHORIZATION AND CANCELLATIONS	Please refer to the website link below for further information. http://www.bradleycorp.com/customerservice/rma
SHIPMENTS AND CLAIMS	Shipments will be made by common carrier and are F.O.B. shipping points. Full freight may be prepaid and allowed on shipments of \$4,000.00 Net or more within continental United States for Washroom Accessories only. Transit damage should be noted on the freight bill before signing for receipt of material. Buyer must submit claims for shortages or other errors in delivery in writing to Seller within 10 calendar days after receipt of shipment. Failure to give such notice shall constitute unqualified acceptance and a waiver of all such claims. Bradley will file the claim with the contracted carrier as a service to the customer, if notified within the specified time period. Customer must hold concealed damaged material for inspection by freight carrier. All delivery dates are approximate. Seller shall not be liable for any damage as a result of any delay or failure to deliver due to any cause beyond Seller's reasonable control. In the event of such delay, the date of delivery shall be extended for a period equal to the time lost because of the delay. Claims for shipment shortages must be faxed within two (2) weeks of invoice date to Bradley with documentation and are subject to factory verification. Due to special packaging requirements, all parcel shipments of mirrors will be subject to \$5.00 per mirror surcharge. The fee for insurance on parcel shipments will be included in the amount added for delivery.
BRADDEX	Orders consisting of items indicated as BradEX (BX) will ship 3 days after receipt of order. The order can ship same day if entered before noon, and will ship the next day if entered noon or later. There is no pricing penalty for this service. To find out more, please contact your local Bradley Sales Representative.
WARRANTY	Product warranties may be found under "product Information" on our web site at www.bradleycorp.com

**All orders are subject to the terms and conditions found at
<http://www.bradleycorp.com/prodinfo/warranty/index.htm>**



Effective Date February 1, 2017

Diplomat Series

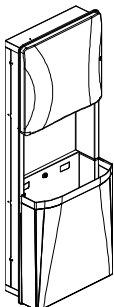
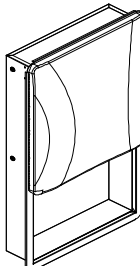
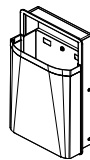
	Model No.	Description	Shipping Data		Price Each \$	
			Cu. Ft.	Wt. Lbs.		
Towel Dispenser/ Waste Receptacle 	2A05	Recessed, Folded Towel, 12 Gallon Capacity	5.90	40.00	\$ 627.00	BX
	2A05-10	Semi-Recessed Model 2A05	5.90	46.70	\$ 744.00	
	2A05-11	Surface-Mounted Model 2A05	5.90	50.46	\$ 786.00	
	2A05-36	Recessed, Folded Towel, 18 Gallon Capacity	6.74	47.04	\$ 645.00	
	2A05-1036	Semi-Recessed Model 2A05-36	6.74	41.90	\$ 800.00	
	2A05-1136	Surface-Mounted Model 2A05-36	6.74	44.15	\$ 822.00	
	2A15-36	Recessed, Mechanical Pull Roll Towel, 21 Gallon Capacity	10.99	61.50	\$ 684.00	
	2A15-1036	Semi-Recessed Model 2A15-36	10.99	71.25	\$ 834.00	
	2A15-1136	Surface-Mounted Model 2A15-36	10.99	76.12	\$ 860.00	
	2A25-36	Recessed, Sensored Roll Towel, 21 Gallon Capacity	10.99	60.50	\$ 741.00	
	2A25-1036	Semi-Recessed Model 2A25-36	10.99	69.00	\$ 848.00	
	2A25-1136	Surface-Mounted Model 2A25-36	10.99	73.87	\$ 871.00	
	2A95-36	Recessed, Dispenser Not Included, 21 Gallon Capacity	10.99	54.50	\$ 645.00	
	2A95-1036	Semi-Recessed Model 2A95-36	10.99	64.25	\$ 800.00	
2A95-1136	Surface-Mounted Model 2A95-36	10.99	69.12	\$ 822.00		
Towel Dispenser 	2A00	Recessed, Folded Towel	3.40	24.42	\$ 309.00	BX
	2A00-10	Semi-Recessed Model 2A00	3.40	24.07	\$ 368.00	
	2A10-11	Surface-Mounted Model 2A00	0.59	5.55	\$ 127.00	
	2A01	Recessed, Mechanical Pull Roll Towel	4.67	35.60	\$ 390.00	
	2A01-10	Semi-Recessed Model 2A01	4.67	42.08	\$ 372.00	
	2A01-11	Surface-Mounted Model 2A01	4.67	45.26	\$ 351.00	
	2A02	Recessed, Sensored Roll Towel	4.67	34.60	\$ 420.00	
	2A02-10	Semi-Recessed Model 2A02	4.67	41.08	\$ 382.00	
	2A02-11	Surface-Mounted Model 2A02	4.67	44.26	\$ 362.00	
	2A09	Recessed, Dispenser Not Included	4.67	29.60	\$ 351.00	
	2A09-10	Semi-Recessed Model 2A09	4.67	36.08	\$ 332.00	
2A09-11	Surface-Mounted Model 2A09	4.67	39.26	\$ 312.00		
Waste Receptacle 	3A05	Recessed, 12 Gallon Capacity	3.60	22.00	\$ 312.00	BX
	3A05-10	Semi-Recessed Model 3A05	3.60	25.66	\$ 334.00	
	3A05-11	Surface-Mounted Model 3A05	3.60	27.87	\$ 342.00	
	3A15-11	Surface-Mounted, 16.5 Gallon Capacity	3.49	19.00	\$ 244.00	
	3A05-36	Recessed, 18 Gallon Capacity	5.53	25.00	\$ 383.00	
	3A05-1036	Semi-Recessed Model 3A05-36	5.53	28.00	\$ 432.00	
	3A05-1136	Surface-Mounted Model 3A05-36	5.53	30.00	\$ 465.00	

Prices subject to change without notice.
 Items may be changed or discontinued without notice
 and without incurring obligation.



Effective Date February 1, 2017

Diplomat Series

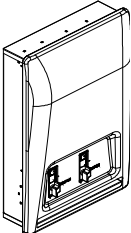
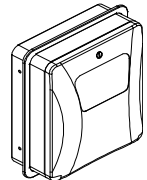
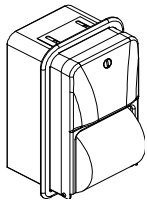
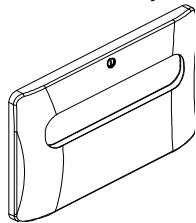
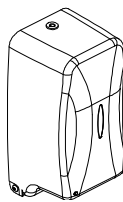
	Model No.	Description	Shipping Data		Price Each \$	
			Cu. Ft.	Wt. Lbs.		
Napkin/Tampon Vendor 	4A20-40	Recessed w/FREE Mechanism	2.32	25.03	\$ 701.00	
	4A20-1140	Surface-Mounted Model 4A20-40	2.32	29.91	\$ 813.00	
	4A20-42	Recessed w/\$.10 Mechanism	2.32	25.03	\$ 701.00	
	4A20-1142	Surface-Mounted Model 4A20-42	2.32	29.91	\$ 813.00	
	4A20-45	Recessed w/\$.25 Mechanism	2.32	25.03	\$ 701.00	
	4A20-1145	Surface-Mounted Model 4A20-45	2.32	29.91	\$ 813.00	
	4A20-43	Recessed w/\$.50 Mechanism	2.32	25.03	\$ 701.00	
	4A20-1143	Surface-Mounted Model 4A20-43	2.32	29.91	\$ 813.00	
	4A20-E43	Recessed w/ €.50 Mechanism	2.32	25.03	\$ 701.00	
	4A20-11E43	Surface-Mounted Model 4A20-E43	2.32	29.91	\$ 813.00	
	4A20-44	Recessed w/\$1.00 Mechanism	2.32	25.03	\$ 701.00	
	4A20-1144	Surface-Mounted Model 4A20-44	2.32	29.91	\$ 813.00	
Napkin Disposal 	4A00	Recessed, 1.5 Gallon Capacity	0.71	7.25	\$ 205.00	BX
	4A00-10	Semi-Recessed Model 4A00	0.71	7.25	\$ 234.00	
	4A10-11	Surface-Mounted, 1.5 Gallon Capacity	0.23	2.75	\$ 59.00	
	4A11	Partition-Mounted, 1.5 Gallon Capacity	0.71	8.05	\$ 264.00	
Toilet Tissue Dispenser 	5A00	Recessed, Dual Roll	0.35	4.50	\$ 129.00	
	5A10-11	Surface-Mounted, Dual Roll	0.26	4.05	\$ 97.00	BX
	5A20	Partition-Mounted, Dual Roll, Serves Two Compartments	0.76	12.09	\$ 215.00	
Seat Cover Dispenser 	5A40-11	Surface-Mounted	0.30	4.55	\$ 78.00	BX
Soap Dispenser 	6A00-11	Surface-Mounted, Sensored Liquid	0.16	2.7	\$ 148.00	BX
	6A01-11	Surface-Mounted, Sensored Foam	0.16	2.7	\$ 177.00	BX

Prices subject to change without notice.
 Items may be changed or discontinued without notice
 and without incurring obligation.



Washroom Accessories Division

TEL: 1-800-BRADLEY FAX: 262-251-5817

Web Site: www.bradleycorp.com

Effective Date February 1, 2017

Series 100 - Multi-Purpose Units

	Model No.	Description	Shipping Data		Price Each \$
			Cu. Ft.	Wt. Lbs.	
	1471	Recessed Towel & Soap Dispenser - Liquid Soap	1.56	8.21	\$ 312.00
	1471-11	Surface-Mtd. Model 1471	1.56	11.50	\$ 379.00
	155	Recessed Towel Dispenser, Exterior Shelf, Mirror Door	1.92	19.24	\$ 246.00
	155-11	Surface-Mtd. Model 155	1.92	24.00	\$ 338.00
	175	Recessed Medicine Cabinet, Interior Shelves, Full Mirror Door	1.92	28.54	\$ 357.00
	175-10	Semi-Recessed Model 175	1.92	31.00	\$ 453.00
	175-11	Surface-Mtd. Model 175	1.92	31.67	\$ 470.00
	198	Towel Dispenser, Exterior Shelf - Behind Mirror or Wall	1.92	14.29	\$ 279.00
	1981	Towel Dispenser - Behind Mirror or Wall	1.01	7.48	\$ 205.00
	1985	Towel Dispenser, Exterior Shelf - Behind Mirror or Wall	1.92	14.85	\$ 279.00

BX

Prices subject to change without notice.
 Items may be changed or discontinued without notice
 and without incurring obligation.



Washroom Accessories Division

TEL: 1-800-BRADLEY FAX: 262-251-5817

Web Site: www.bradleycorp.com

Effective Date February 1, 2017

Series 200 - Towel Dispenser/Waste Receptacle

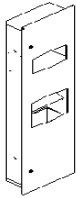
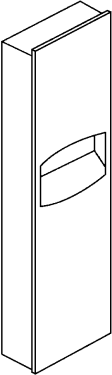
	Model No.	Description	Shipping Data		Price Each \$	
				Cu. Wt. Lbs. Ft.		
	270	Recessed, Multipurpose Unit Towel Dispenser/Hand Dryer/ Waste Receptacle	6.24	52.00	\$995.00	
	270-10	Semi-Recessed Model 270	6.24	52.00	\$1,027.00	
	270-11	Surface-Mtd. Model 270	6.24	52.00	\$1,059.00	
	270-49	Recessed, Multipurpose Unit Towel Dispenser/Hand Dryer/ Waste Receptacle, 230V, 50 Hz	6.24	52.00	\$995.00	
	270-1049	Semi-Recessed Model 270-49	6.24	52.00	\$1,027.00	
	270-1149	Surface-Mtd. Model 270-49	6.24	52.00	\$1,059.00	
	TOWEL DISPENSER/ WASTE RECEPTACLE 	2017	Recessed, Contemporary Series, 5.75 Gal. Cap.	5.19	38.00	\$ 398.00
2017-10		Semi-Recessed Model 2017	5.19	42.00	\$ 472.00	BX
2017-11		Surface-Mtd. Model 2017	5.19	44.00	\$ 547.00	
2027		Recessed, Contemporary Series, 3.75 Gal. Cap.	3.75	30.15	\$ 334.00	BX
2027-10		Semi-Recessed Model 2027	3.75	34.19	\$ 504.00	
2027-11		Surface-Mtd. Model 2027	3.75	36.99	\$ 479.00	
2037		Recessed, Contemporary Series, 12 Gal. Cap.	5.90	45.51	\$ 519.00	
2037-10		Semi-Recessed Model 2037	5.90	58.00	\$ 719.00	
2037-11		Surface-Mtd. Model 2037	5.90	62.00	\$ 773.00	
225		Recessed, 10.5 Gal. Cap.	6.92	50.00	\$ 624.00	
225-10		Semi-Recessed Model 225	6.92	62.00	\$ 776.00	
225-11		Surface-Mtd. Model 225	6.92	66.00	\$ 838.00	
2251		Recessed, 6 Gal. Cap.	5.19	33.56	\$ 466.00	
2251-10		Semi-Recessed Model 2251	5.19	43.00	\$ 624.00	
2251-11		Surface-Mtd. Model 2251	5.19	44.00	\$ 684.00	
2252		Recessed, 5.75 Gal. Cap.	5.19	35.82	\$ 601.00	
2252-10		Semi-Recessed Model 2252	5.19	45.40	\$ 589.00	
2252-11		Surface Mtd Model 2252	5.19	39.40	\$ 665.00	
227		Recessed, 18 Gal. Cap. - Roll Towel	8.27	72.00	\$ 670.00	
227-10		Semi-Recessed Model 227 - Roll Towel	8.27	65.00	\$ 770.00	
227-11		Surface Mtd Model 227 - Roll Towel	8.27	65.00	\$ 856.00	
227-1165		Surface Mtd Model 227, Hinged Cover w/Push Flap Door-RT	10.40	65.00	\$ 973.00	
2271		Recessed, 18 Gal. Cap.- Dispenser Not Included	8.27	65.00	\$ 528.00	
2271-10	Semi-Recessed Model 2271- Dispenser Not Included	8.27	70.00	\$ 667.00		
2271-11	Surface Mtd Model 2271- Dispenser Not Included	8.27	75.00	\$ 770.00		
2277	Recessed, Contemporary Series, 8.6 Gal. Cap.	8.27	52.26	\$ 686.00	BX	
2277-10	Semi-Recessed Model 2277	8.27	45.00	\$ 829.00		
2277-11	Surface Mtd Model 2277	8.27	45.00	\$ 871.00		

Prices subject to change without notice.
 Items may be changed or discontinued without notice
 and without incurring obligation.



Washroom Accessories Division

TEL: 1-800-BRADLEY FAX: 262-251-5817

Web Site: www.bradleycorp.com

Effective Date February 1, 2017

Series 200 - Towel Dispenser/Waste Receptacle

	Model No.	Description	Shipping Data		Price Each \$	
			Cu. Ft.	Wt. Lbs.		
TOWEL DISPENSER/ WASTE RECEPTACLE	229	Recessed, 1.25 Gal. Cap.	0.86	7.28	\$ 200.00	
	229-10	Semi-Recessed Model 229	0.86	9.58	\$ 314.00	
	229-11	Surface Mtd Model 229	0.86	10.53	\$ 264.00	
	2291	Recessed, 2 Gal. Cap.	2.88	12.15	\$ 146.00	BX
	2291-10	Semi-Recessed Model 2291	1.76	15.02	\$ 213.00	
	2291-11	Surface Mtd Model 2291	2.88	16.00	\$ 221.00	BX
	2297	Recessed, Contemporary Series, 2 Gal. Cap.	1.76	18.32	\$ 244.00	BX
	2297-10	Semi-Recessed Model 2297	1.76	21.00	\$ 362.00	
	2297-11	Surface Mtd Model 2297	1.76	22.21	\$ 379.00	
	234	Recessed, 12 Gal. Cap.	6.74	35.61	\$ 294.00	BX
	234-10	Semi-Recessed Model 234	6.74	40.43	\$ 394.00	BX
	234-11	Surface-Mtd. Model 234	6.19	45.00	\$ 410.00	BX
	234-35	Recessed, 12 Gal. Cap, Hinged Cover	6.19	38.06	\$ 391.00	
	234-65	Recessed, 12 Gal. Cap, Hinged Cover with Push Flap Door	6.19	38.16	\$ 414.00	
	235	Recessed, 4.2 Gal. Cap.	3.75	35.66	\$ 373.00	BX
	235-10	Semi-Recessed Model 235	3.75	38.90	\$ 443.00	
	235-11	Surface-Mtd. Model 235	3.75	44.69	\$ 459.00	
	236	Recessed, Center-pull 12 Gal. Cap.	9.72	46.00	\$ 495.00	
	236-10	Semi-Recessed, Center-pull 12 Gal. Cap.	8.27	55.00	\$ 566.00	
	236-11	Surface-Mtd., Center-pull 12 Gal. Cap.	9.72	59.00	\$ 626.00	
	237	Recessed 12 Gal. Cap.	5.90	42.52	\$ 416.00	
	237-10	Semi-Recessed Model 237	5.90	46.57	\$ 529.00	
	237-11	Surface-Mtd. Model 237	5.90	54.00	\$ 549.00	
	238	Recessed 8 Gal. Cap.	5.90	41.20	\$ 451.00	
	238-10	Semi-Recessed Model 238	5.90	47.97	\$ 563.00	
	238-11	Surface-Mtd. Model 238	5.90	61.00	\$ 622.00	

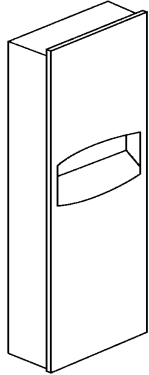

Prices subject to change without notice.
Items may be changed or discontinued without notice
and without incurring obligation.



Washroom Accessories Division

TEL: 1-800-BRADLEY FAX: 262-251-5817

Web Site: www.bradleycorp.com

Effective Date February 1, 2017

Series 200 - Towel Dispenser/Combination Units

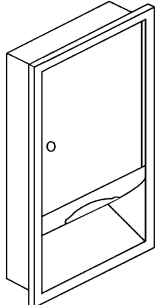
	Model No.	Description	Shipping Data		Price Ea. \$	
			Cu. Ft.	Wt. Lbs.		
TOWEL DISPENSER 	244	Recessed	2.63	12.02	\$ 166.00	
	244-10	Semi-Recessed Model 244	2.63	16.00	\$ 244.00	
	244-11	Surface-Mtd. Model 244	2.63	16.25	\$ 233.00	
	2441	Recessed	0.59	7.02	\$ 100.00	BX
	2441-10	Semi-Recessed Model 2441	0.56	8.47	\$ 186.00	
	2441-11	Surface-Mtd. Model 2441	0.56	10.00	\$ 188.00	BX
	2442	Recessed, Contemporary Series	0.86	8.16	\$ 149.00	BX
	2442-10	Semi-Recessed Model 2442	0.86	20.00	\$ 234.00	
	2442-11	Surface-Mtd. Model 2442	0.86	10.00	\$ 277.00	
	2447	Recessed, Contemporary Series	2.63	15.74	\$ 220.00	
	2447-10	Semi-Recessed Model 2447	2.63	21.00	\$ 347.00	
	2447-11	Surface-Mtd. Model 2447	2.63	23.00	\$ 366.00	
	247	Recessed	2.63	18.00	\$ 318.00	
	247-10	Semi-Recessed Model 247	2.63	21.00	\$ 467.00	
247-11	Surface-Mtd. Model 247	2.63	26.00	\$ 499.00		
CENTERPULL TOWEL DISPENSER	2479	Recessed	4.72	19.00	\$ 293.00	
	2479-10	Semi-Recessed, Model 2479	4.72	22.00	\$ 416.00	
	2479-11	Surface Mtd, Model 2479	4.72	18.00	\$ 194.00	
ROLL TOWEL DISPENSER	2482-11	Surface-Mtd. Push Bar	1.68	15.00	\$ 262.00	
	2483	Surface-Mtd. Lever	1.68	16.25	\$ 269.00	BX
	2484	Recessed, Lever	4.72	42.00	\$ 559.00	
	2484-10	Semi-Recessed, Lever	4.72	42.00	\$ 683.00	
	2494	Roll Towel Dispenser - Sensored, Surface-Mtd.	1.02	5.40	\$ 170.00	BX
	2495	Roll Towel Dispenser - Lever Operated, Surface-Mtd.	1.30	5.65	\$ 266.00	
	2496	Roll Towel Dispenser - Sensored, Surface-Mtd.	1.02	5.40	\$ 167.00	BX
2497	Roll Towel Dispenser - Push-Lever Operated, Surface-Mtd.	1.14	4.90	\$ 233.00	BX	
FOLDED TOWEL DISPENSER	250-15	Surface-Mtd. (6 per master carton)	0.39	5.08	\$ 46.00	BX
	251-15	Surface-Mtd. (8 per master carton)	3.41	6.00	\$ 66.00	BX
	252	Surface-Mtd. (12 per master carton)	0.23	3.00	\$ 54.00	BX
	250-33	White Enamel, Surface-Mtd.	0.39	3.57	\$ 72.00	
	259	Surface-Mtd., Accommodates Roll Paper Towels	0.02	1.53	\$ 22.00	

Prices subject to change without notice.
 Items may be changed or discontinued without notice
 and without incurring obligation.



Washroom Accessories Division

TEL: 1-800-BRADLEY FAX: 262-251-5817

Web Site: www.bradleycorp.com

Effective Date February 1, 2017

Series 200 - Electric Dryers

	Model No.	Description	Shipping Data		Price Each \$	
			Cu. Ft.	Wt. Lbs.		
AERIX + HAND DRYER	2921-W	ABS, White, 110-120V, Surf-Mtd, ADA, Adj Dry Time	3.22	23.50	\$ 1,574.00	BX
	2921-S	ABS, Silver, 110-120V, Surf-Mtd, ADA, Adj Dry Time	3.22	23.50	\$ 1,574.00	BX
	2921-SCE	ABS, Silver, 220-240V, Surf-Mtd, ADA, Adj Dry Time	3.22	23.50	\$ 1,574.00	
	2922-2873	Aluminum, White, 110-120V, Adj Dry Time, Heated, Surf-Mtd	0.35	12.70	\$ 605.00	BX
	2922-2874	SS - Satin, 110-120V, Adj Dry Time, Heated, Surf-Mtd	0.35	14.20	\$ 635.00	BX
AERIX HAND DRYER	2901-2873	Steel, White, Surf-Mtd, Universal Voltage, Adj Dry Time	0.50	10.40	\$ 532.00	BX
	2901-2874	SS - Satin, Surf-Mtd, Universal Voltage, Adj Dry Time	0.50	10.40	\$ 569.00	BX
	2902-28	Cast Iron, White, Surf-Mtd, ADA, Universal Voltage, Adj Dry Time	0.75	15.20	\$ 470.00	BX
	2902-2873	Steel, White, Surf-Mtd, ADA, Universal Voltage, Adj Dry Time	0.75	7.90	\$ 453.00	BX
	2902-2874	SS - Satin, Surf-Mtd, ADA, Universal Voltage, Adj. Dry Time	0.75	7.90	\$ 490.00	BX
	2903-28	Cast Iron, White, Surface-Mtd	1.08	25.35	\$ 439.00	BX
	2903-2800CE	Cast Iron, White, Surface-Mtd, CE - European Export	1.08	25.35	\$ 439.00	
	2904-28	Cast Iron, White, Surface-Mtd	1.08	25.35	\$ 439.00	BX
	2904-2800CE	Cast Iron, White, Surface-Mtd	1.08	25.35	\$ 439.00	
	2905-2873	Steel, White, Surf-Mtd.	0.91	15.00	\$ 266.00	BX
	2905-2873CE	Steel, White, Surf-Mtd, CE - European Export	0.91	15.00	\$ 266.00	

Prices subject to change without notice.
 Items may be changed or discontinued without notice
 and without incurring obligation.



Washroom Accessories Division

TEL: 1-800-BRADLEY FAX: 262-251-5817

Web Site: www.bradleycorp.com

Effective Date February 1, 2017

Series 300 - Waste Receptacles

	Model No.	Description	Shipping Data		Price Each \$		
			Cu. Ft.	Wt. Lbs.			
WASTE RECEPTACLES	P10-696	Circular Waste Chute	0.90	1.70	\$ 73.00	BX	
	315-35	Recessed 10.5 Gal. Cap.	4.71	34.63	\$ 414.00		
	315-1035	Semi-Recessed Model 315	4.71	40.00	\$ 558.00		
	315-1135	Surface-Mtd. Model 315	4.71	47.00	\$ 639.00		
	3157	Recessed, 9.2 gal. Cap.	4.71	40.00	\$ 445.00		
	3157-10	Semi-Recessed Model 3157	4.71	41.31	\$ 566.00		
	3251	Recessed, 2.8 Gal. Cap.	2.63	15.30	\$ 231.00		
	3251-10	Semi-Recessed, Model 3251	2.63	23.00	\$ 311.00		
	3251-11	Surface-Mtd. Model 3251	2.63	25.00	\$ 312.00		
	3257	Recessed, Contemporary Series, 2.5 Gal. Cap.	2.63	19.26	\$ 281.00		
	334	Recessed, 18 Gal. Cap.	3.48	25.00	\$ 249.00	BX	
	334-10	Semi-Recessed, 18 Gal. Cap.	3.48	41.00	\$ 322.00		
	334-11	Surface-Mtd. Model 334	3.48	43.00	\$ 332.00		
	344	Recessed, 12 Gal. Cap.	3.40	22.20	\$ 228.00	BX	
	344-10	Semi-Recessed Model 344	3.40	24.07	\$ 281.00		
	344-11	Surface-Mtd. Model 344	3.40	24.72	\$ 310.00		
	346	Recessed, 12 Gal. Cap.	3.40	33.00	\$ 257.00		
	346-10	Semi-Recessed Model 346	3.40	41.00	\$ 324.00		
	346-11	Surface-Mtd. Model 346	3.40	28.14	\$ 355.00		
	355	Surface-Mtd. 20.6 Gal. Cap.	3.74	15.91	\$ 169.00		
	356	Surface-Mtd. 16.5 Gal. Cap.	3.31	14.59	\$ 143.00		
	3565	Surface-Mtd. 12 Gal. Cap	3.16	13.60	\$ 122.00		
	357	Surface-Mtd. 6.5 Gal. Cap.	1.05	7.74	\$ 89.00	BX	
	359	Surface-Mtd. 1.5 Gal. Cap.	0.56	3.12	\$ 70.00		
	377	Freestanding, 13 Gal. Cap.	2.80	17.00	\$ 296.00		
	377-37	Freestanding, 13 Gal. Cap., Less Swing Top	4.95	9.80	\$ 167.00		
	377-36	Freestanding, 21 Gal. Cap.	4.66	22.70	\$ 378.00		
	377-3637	Freestanding, 21 Gal. Cap., Less Swing Top	4.95	18.45	\$ 250.00		
	377-38	Freestanding, 36 Gal. Cap.	7.01	31.80	\$ 460.00		
	377-3738	Freestanding, 36 Gal. Cap., Less Swing Top	7.30	25.00	\$ 311.00		
	OPTIONS	-35	Hinged Cover	Add	0.00 1.00	*	
		-38	Extra Large Capacity			*	
	-65	Hinged Cover with Push-Flap D.	Add	0.00 2.00	*		

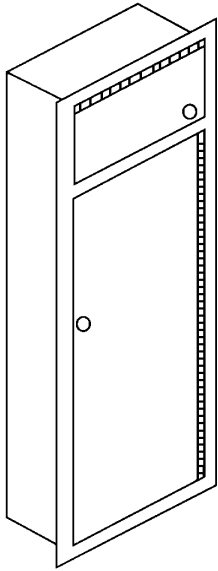

Notes *For information on options on this page please contact your local Sales Representative or Customer Service



Washroom Accessories Division

TEL: 1-800-BRADLEY FAX: 262-251-5817

Web Site: www.bradleycorp.com

Effective Date February 1, 2017

Series 400 - Napkin/Tampon Vendors & Disposals

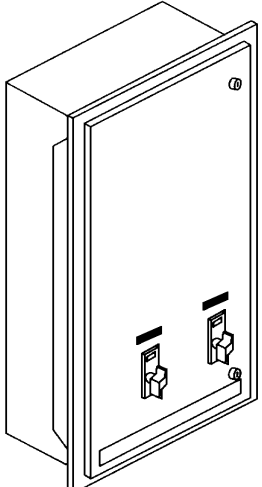
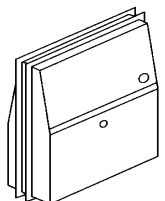
	Model No.	Description	Shipping Data		Price Ea. \$	
			Cu. Ft.	Wt. Lbs.		
	NAPKIN/TAMPON VENDOR	401	Recessed or Semi-Recessed, 30 Napkins-28 Tampons (specify coinage)			
	401-40	401 with Free Mechanism	2.32	25.00	\$ 436.00	
	401-42	401 with 10¢ Mechanism	2.32	25.11	\$ 436.00	
	401-43	401 with 50¢ Mechanism	2.32	25.12	\$ 436.00	
	401-45	401 with 25¢ Mechanism	2.32	25.22	\$ 436.00	BX
	4017	Recessed, Contemporary Series, 30 Napkins-28 Tampons (specify coinage)				
	4017-40	4017 with Free Mechanism	2.32	24.00	\$ 401.00	
	4017-42	4017 with 10¢ Mechanism	2.32	24.62	\$ 401.00	
	4017-43	4017 with 50¢ Mechanism	2.32	25.14	\$ 401.00	
	4017-45	4017 with 25¢ Mechanism	2.32	24.81	\$ 401.00	
	4017-10	Semi-Recessed, Model 4017 (specify coinage)				
	4017-1040	4017-10 with Free Mechanism	2.32	28.17	\$ 413.00	
	4017-1042	4017-10 with 10¢ Mechanism	2.32	28.15	\$ 413.00	
	4017-1043	4017-10 with 50¢ Mechanism	2.32	28.27	\$ 413.00	
	4017-1045	4017-10 with 25¢ Mechanism	2.32	28.04	\$ 413.00	
	4017-11	Surface-Mtd., Model 4017 (specify coinage)				
	4017-1144	4017-11 with \$1 Mechanism	2.34	30.58	\$ 436.00	
	4017-1145	4017-11 with 25¢ Mechanism	2.32	30.58	\$ 436.00	
	407	Recessed., (specify coinage)				
	407-40	407 with Free Mechanism	1.30	22.76	\$ 399.00	
407-42	407 with 10¢ Mechanism	1.31	21.85	\$ 399.00		
407-43	407 with 50¢ Mechanism	1.30	22.76	\$ 399.00		
407-44	407 with \$1 Mechanism	1.30	22.76	\$ 399.00		
407-45	407 with 25¢ Mechanism	1.30	22.76	\$ 399.00	BX	
407-11	Surface-Mtd., (specify coinage)					
407-1145	407-11 with 25¢ Mechanism	2.35	30.58	\$ 552.00	BX	
	NAPKIN DISPOSAL	4721-15	Partition Mtd. Dual Use, 1.5 Gal. Cap.		\$ 143.00	BX
	4722-15	Surface-Mtd., for End Compartment, 1.5 Gal. Cap.	0.56	7.60	\$ 90.00	BX
	4722-1015	Semi-Recessed Model 4722-15	0.56	8.39	\$ 125.00	BX
	4731-15	Recessed	0.56	8.52	\$ 112.00	BX
	4737	Recessed, Contemporary Series, 1.5 Gal. Cap.	0.93	9.65	\$ 196.00	
	4737-10	Semi-Recessed Model 4737	0.93	12.00	\$ 300.00	
	4737-11	Surface-Mtd. Model 4737	0.93	13.00	\$ 312.00	
	4781-15	Surface-Mtd. (6 per master carton)	1.75	3.20	\$ 41.00	BX
	4791-15	Surface-Mtd., With Shelf	0.54	4.00	\$ 64.00	

Prices subject to change without notice.
 Items may be changed or discontinued without notice
 and without incurring obligation.



Washroom Accessories Division

TEL: 1-800-BRADLEY FAX: 262-251-5817

Web Site: www.bradleycorp.com

Effective Date February 1, 2017

Series 500 - Toilet Tissue Holders

	Model No.	Description	Shipping Data		Price Ea. \$	
			Cu. Ft.	Wt. Lbs.		
	505	Surface-Mtd., Die Cast Zinc	0.03	1.02	\$ 13.00	BX
	5053	Surface-Mtd., Aluminum	0.02	0.35	\$ 15.00	
	5054	Surface-Mtd., Chrome Plated Steel	0.05	0.69	\$ 6.00	BX
	5061	Surface-Mtd., Bright Polish	0.06	1.16	\$ 26.00	
	5071	Surface-Mtd., Controlled Delivery, Aluminum	0.03	0.58	\$ 8.00	
	5071-50	Surface-Mtd., Non-controlled Delivery, Aluminum	0.02	0.66	\$ 8.00	
	508*	Surface-Mtd., Chrome Plated Brass	0.03	1.08	\$ 24.00	
	508-32	Surface-Mtd., Die Cast Zinc	0.02	0.64	\$ 12.00	BX
	5084*	Surface-Mtd., Satin Stainless Steel	0.03	0.57	\$ 14.00	BX
	5085*	Surface-Mtd., Bright Polish	0.06	0.48	\$ 15.00	BX
	5102*	Recessed, Bright Finish Stainless Steel Housing	0.10	0.88	\$ 20.00	
	5103*	Recessed, With Hood	0.03	1.09	\$ 33.00	
	5104*	Recessed, Satin Finish Stainless Steel Housing*	0.10	0.87	\$ 20.00	
	5106*	Surface-Mtd., with Hood, Bright Polish	0.12	1.55	\$ 36.00	BX
	OPTIONS	-55	Back Clamp for Gypsum Wallboard Mounting	0.00	0.00	*
DOUBLE ROLL TOILET TISSUE HOLDER	5105	Recessed, Roll in Reserve	0.23	1.27	\$ 41.00	
	5123*	Recessed, Bright Polish, With Hood	0.18	2.11	\$ 70.00	
	5124*	Recessed, Satin Stainless Steel (See Options)	0.30	2.00	\$ 44.00	
	5125*	Recessed, Bright Polish (See Options)	0.30	2.01	\$ 44.00	
	5126*	Surface Mtd, with Hood, Bright Polish	0.23	3.50	\$ 70.00	BX
	5127	Recessed, Vertical Orientation, Bright Polish Stainless Steel, With Hood	0.23	2.51	\$ 55.00	BX
	522	Surface Mtd, Die Cast Zinc	0.08	1.61	\$ 18.00	BX
	5224	Surface Mtd, Chrome Plated Steel	0.09	1.37	\$ 13.00	BX
	523	Surface Mtd, Die Cast Zinc	0.07	1.00	\$ 20.00	
	5234*	Surface Mtd, Satin Stainless Steel	0.04	0.87	\$ 21.00	BX
	5235*	Surface Mtd, Bright Polish	0.04	0.87	\$ 22.00	BX
	5241	Surface Mtd, Controlled Delivery, Aluminum	0.06	1.20	\$ 15.00	BX
	5241-50	Non-controlled Delivery ADA Approved, Aluminum	0.06	1.07	\$ 15.00	BX
	5262	Surface Mtd, Single w/Shelf	0.26	3.00	\$ 66.00	
	5263*	Surface Mtd, Double w/Shelf	0.26	3.40	\$ 60.00	BX
	5402	Surface-Mtd. (8 per master carton)	0.22	3.90	\$ 58.00	BX
	5412	Recessed (6 per master carton)	0.36	5.56	\$ 96.00	BX
	5422	Partition Mtd.	0.76	10.99	\$ 213.00	BX
	5424	Surface-Mtd., Single Jumbo Roll (10")	3.04	5.00	\$ 44.00	BX
	5425	Surface-Mtd., Double Jumbo Roll (9")	1.06	9.00	\$ 139.00	BX

Notes

*For information on options on this page please contact your local Sales Representative or Customer Service



Washroom Accessories Division

TEL: 1-800-BRADLEY FAX: 262-251-5817

Web Site: www.bradleycorp.com

Effective Date February 1, 2017

Series 500 - Toilet Tissue Holders

	Model No.	Description	Shipping Data		Price Ea. \$	
			Cu. Ft.	Wt. Lbs.		
FOLDED TOILET TISSUE DISPENSER	515	Surface-Mtd., Stainless Steel	0.10	1.58	\$ 24.00	
SEAT COVER DISPENSERS	582	Recessed, Partition mounted	0.96	8.87	\$ 261.00	
	583	Surface-Mtd.	0.52	4.66	\$ 88.00	BX
	5831	Surface-Mtd.	0.51	2.80	\$ 37.00	BX
	584	Recessed	0.52	4.78	\$ 86.00	
	5847	Recessed, Contemporary Series	0.86	7.35	\$ 148.00	BX
IN-STALL COMBINATION UNITS	591	Partition Mtd.	3.38	27.56	\$ 410.00	BX
	5911	Partition Mtd.	2.00	25.40	\$ 423.00	
	5911-69	Partition Mtd., reverse door	2.00	25.40	\$ 423.00	
	5912	Recessed	2.00	20.66	\$ 319.00	BX
	5912-11	Surface-Mtd.	3.38	20.81	\$ 406.00	
	5912-69	Recessed, reverse door	3.38	20.70	\$ 319.00	
	5912-1169	Surface-Mtd., reverse door	3.70	20.81	\$ 406.00	
	592	Partition Mtd.	3.38	25.21	\$ 356.00	
	5921	Partition Mtd.	2.00	22.99	\$ 357.00	
	5921-69	Partition Mtd., reverse door	2.00	22.99	\$ 357.00	
	5922	Recessed	2.00	19.16	\$ 264.00	BX
	5922-10	Semi-Recessed	2.00	22.25	\$ 318.00	
	5922-11	Surface-Mtd.	2.00	17.79	\$ 374.00	
	5922-69	Recessed, reverse door	2.00	19.16	\$ 264.00	
	5922-1169	Surface-Mtd., reverse door	3.70	17.79	\$ 374.00	
	5932	Recessed	2.00	19.94	\$ 444.00	
	594	Partition Mtd.	3.38	21.85	\$ 444.00	
	5941	Partition Mtd.	2.00	21.50	\$ 368.00	
	5942	Recessed	2.00	16.00	\$ 300.00	
	5942-11	Surface-Mtd.	2.00	16.04	\$ 327.00	
	5942-69	Recessed, reverse door	2.11	14.90	\$ 300.00	
	5951	Recessed	3.40	27.13	\$ 978.00	
	5952	Recessed	3.40	27.13	\$ 978.00	

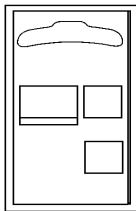

Prices subject to change without notice.
 Items may be changed or discontinued without notice
 and without incurring obligation.



Washroom Accessories Division

TEL: 1-800-BRADLEY FAX: 262-251-5817

Web Site: www.bradleycorp.com

Effective Date February 1, 2017

Series 600 - Soap Dispensers

	Model No.	Description	Shipping Data		Price Each \$	
			Cu. Ft.	Wt. Lbs.		
LAV-MTD. LIQUID SOAP DISPENSER	6315	Sensored, 5-1/2" Spout	0.18	1.59	\$ 129.00	BX
	6315-KT0000	Starter Kit, includes 6315, (4) "D" Cell batteries, and (1) btl. soap	0.37	6.00	\$ 166.00	BX
	6322	Poly Globe, 2 1/2" Spout	0.10	1.10	\$ 34.00	
	6322-67	Metal Globe, 2 1/2" Spout	0.03	1.33	\$ 44.00	
	6322-68	Poly Globe, 2 1/2" Spout - 32 oz. Polyethylene Globe	0.06	0.84	\$ 37.00	
	6324	Poly Globe, 4" Spout	0.12	1.05	\$ 34.00	BX
	6324-67	Metal Globe, 4" Spout	0.04	1.37	\$ 46.00	
	6324-68	Poly Globe, 4" Spout - 32 oz. Polyethylene Globe	0.08	1.20	\$ 34.00	BX
	6326	Poly Globe, 6" Spout	0.10	1.14	\$ 40.00	BX
	6326-67	Metal Globe, 6" Spout	0.05	1.37	\$ 49.00	
	6326-68	Poly Globe, 6" Spout - 32 oz. Polyethylene Globe	0.06	0.87	\$ 40.00	BX
	6334	Poly Globe, 3 1/2" Spout - 16 oz. Polyethylene Bottle "Frequency"	0.10	1.20	\$ 102.00	
	LIQUID SOAP DISPENSER	643	Recessed, Horizontal	0.44	3.00	\$ 88.00
6437		Recessed, Contemporary Series	0.44	3.51	\$ 108.00	
644		Recessed, Vertical	0.44	3.32	\$ 125.00	
648		Plastic Globe, Swivel, Push-up Soap Valve, Surface-Mtd.	0.07	0.99	\$ 11.00	
6481		Plastic Globe, Fixed, Push-up Soap Valve, Surface-Mtd.	0.06	0.40	\$ 10.00	
650		Plastic Globe, Push-up Soap Valve, 34 Fl. ounces	0.14	0.70	\$ 15.00	
6501		Plastic Globe, Push-up Soap Valve, 24 Fl. ounces	0.09	1.00	\$ 13.00	BX
6531		Surface-Mtd.	0.24	2.17	\$ 46.00	
6542		Surface-Mtd., Tank Type - Horizontal (24 per master carton)	0.15	2.00	\$ 33.00	BX
655		Vertical Valve - Surface-Mtd.	0.16	1.79	\$ 64.00	
6562		Surface-Mtd., Tank Type - Vertical (24 per master carton)	0.07	1.55	\$ 38.00	BX
6563		Surface-Mtd., Tank Type - Vertical	0.15	1.71	\$ 32.00	BX
657		Surface-Mtd., Urn Type	0.07	1.21	\$ 26.00	
661	Surface-Mtd., 1 Valve, Shelf Type	0.17	4.64	\$ 86.00		
662	Surface-Mtd., 2 Valves, Shelf Type	0.24	5.08	\$ 102.00		
6843	Surface-Mtd., Foot Operated	0.23	1.91	\$ 30.00		
POWDERED SOAP DISPENSER	658-30	Surface-Mtd., Satin Stainless Steel	0.09	1.35	\$ 29.00	
	6583	Surface-Mtd., Satin Stainless Steel	0.11	1.78	\$ 43.00	

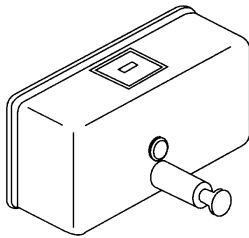

Prices subject to change without notice.
 Items may be changed or discontinued without notice
 and without incurring obligation.



Washroom Accessories Division

TEL: 1-800-BRADLEY FAX: 262-251-5817

Web Site: www.bradleycorp.com

Effective Date February 1, 2017

Series 780 & 781 - Stainless Steel Mirrors

	BX	780	BX	781
16 x 20		\$ 79.00		\$ 63.00
16 x 24		\$ 74.00		\$ 55.00
16 x 30		\$ 90.00		\$ 79.00
18 x 24		\$ 81.00	BX	\$ 49.00
18 x 30	BX	\$ 76.00	BX	\$ 55.00
18 x 32		\$ 156.00		\$ 109.00
18 x 36	BX	\$ 82.00	BX	\$ 67.00
18 x 60		\$ 169.00		\$ 129.00
20 x 36		\$ 182.00		\$ 132.00
20 x 60		\$ 183.00		\$ 155.00
24 x 30		\$ 111.00	BX	\$ 75.00
24 x 36	BX	\$ 94.00	BX	\$ 82.00
24 x 42		\$ 233.00		\$ 168.00
24 x 48		\$ 155.00		\$ 129.00
24 x 60	BX	\$ 160.00	BX	\$ 140.00
24 x 72		\$ 285.00		\$ 281.00
30 x 36		\$ 168.00		\$ 131.00
36 x 36		\$ 184.00	BX	\$ 168.00
36 x 48		\$ 355.00		\$ 216.00
36 x 72		\$ 540.00		\$ 411.00
48 x 30		\$ 221.00		\$ 178.00
48 x 36		\$ 238.00		\$ 211.00
60 x 24		\$ 242.00		\$ 205.00
60 x 36		\$ 311.00		\$ 269.00
72 x 36		\$ 419.00		\$ 361.00



Skid Qty. 15

780- Angle Frame Mirror
781- Channel Frame Mirror

Mirror Options

Suffix	Description
-2	1/4" Tempered Plate Glass (max. size = 96x60)
-3	Laminate Glass (max. size = 84x48)
-4	Polished Stainless Steel (SS) in Lieu of Glass, # 8 Architectural Grade Finish on 304 Series SS (max. size = 120x47-1/2)
-5	Bright Annealed SS in Lieu of Glass (max. size = 120x47-1/2)
-6	Plexiglass (max. size = 96x60)

Tempered Glass Option -2			
18 x 30		\$ 114.00	\$ 102.00
18 x 36	BX	\$ 136.00	\$ 118.00
24 x 36	BX	\$ 160.00	\$ 150.00
24 x 60		\$ 251.00	
20 x 60			\$ 215.00

For pricing on special sizes and options not listed on this page please contact your local Sales Representative or Customer Service.

Notes

- Bradley mirrors are overall sizes. Ex. Model 780-1824 measures overall 18"w x 24"h. **Always specify width first.** Height must be between 12" and 72".
- Bradley mirrors are not field interchangeable from horizontal to vertical or vice versa. Ex. Model 780-1824 will mount only 18"w x 24"h, not 24"w x 18"h.
- SHIPPING WEIGHT - To determine approximate shipping weight use a multiplier of 6.25 lbs. Per square foot. Formula: W" x H" divided by 144 x 6.25 = weight.
- Mirrors over 30"w include two (2) hangers.
- MIRROR WEIGHT - Mirror with one hanger max weight 75 lbs. Mirror with two (2) hangers max weight 200 lbs. To find raw mirror weight, use calculation of W" x H" divided by 144 x 5 = weight.

Due to special packaging requirements, all parcel-sized shipments of mirrors will be subject to a \$5.00 per mirror surcharge. The fee for insurance on parcel-sized shipments will be included in the amount added for delivery.

Tempered, Laminated, Plexiglass, and Stainless Steel provide extra security from broken glass and, as a result, may differ in color and reflectivity from standard mirrors. These mirrors will not be accepted for return because of distortion.

Prices subject to change without notice.
Items may be changed or discontinued without notice and without incurring obligation.



Washroom Accessories Division

TEL: 1-800-BRADLEY FAX: 262-251-5817
 Web Site: www.bradleycorp.com

Effective Date February 1, 2017

Series 7805 & 7815 - Stainless Steel Mirrors With Shelf

	BX	7805	BX	7815
16 x 24		\$ 114.00		\$ 123.00
18 x 24		\$ 117.00		\$ 117.00
18 x 30		\$ 127.00		\$ 127.00
18 x 36	BX	\$ 136.00		\$ 138.00
24 x 30		\$ 160.00		\$ 155.00
24 x 36		\$ 171.00	BX	\$ 156.00
48 x 36		\$ 378.00		\$ 338.00



7805- Angle Frame
 7815- Channel Frame

For pricing on special sizes and options not listed on this page please contact your local Sales Representative or Customer Service.

Mirror Options

Suffix	Description
-2	1/4" Tempered Plate Glass (max. size = 96x60)
-3	Laminate Glass (max. size = 84x48)
-4	Polished Stainless Steel (SS) in Lieu of Glass, # 8 Architectural Grade Finish on 304 Series SS (max. size = 120x47-1/2)
-5	Bright Annealed SS in Lieu of Glass (max. size = 120x47-1/2)
-6	Plexiglass (max. size = 96x60)

Notes

- Bradley mirrors are overall sizes. Ex. Model 7815-1824 measures overall 18"w x 24"h. **Always specify width first.** (Max width is 96").
- Bradley mirrors are not field interchangeable from horizontal to vertical or vice versa. Ex. Model 7805-1824 will mount only 18"w x 24"h, not 24"w x 18"h.
- SHIPPING WEIGHT - To determine approximate shipping weight use a multiplier of 6.25 lbs. Per square foot. Formula: W" x H" divided by 144 x 6.25 = weight.
- Mirrors over 30"w have two (2) hangers.

Due to special packaging requirements, all parcel-sized shipments of mirrors will be subject to a \$5.00 per mirror surcharge. The fee for insurance on parcel-sized shipments will be included in the amount added for delivery.

Tempered, Laminated, Plexiglass, and Stainless Steel provide extra security from broken glass but may differ in color and reflectivity from standard mirrors. These mirrors will not be accepted for return because of distortion.









Washroom Accessories Division

TEL: 1-800-BRADLEY FAX: 262-251-5817

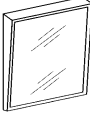
Web Site: www.bradleycorp.com

Effective Date February 1, 2017

Series 700 - Specialty Poly Glaze® Mirror Units

	Model No.	Description	Price Each (\$)	
 <p>740 FIXED TILT STAINLESS STEEL FRAMED MIRRORS</p>	740-1624	16 inches wide by 24 inches high	\$ 136.00	
	740-1630	16 inches wide by 30 inches high	\$ 156.00	
	740-1824	18 inches wide by 24 inches high	\$ 142.00	
	740-1830	18 inches wide by 30 inches high	\$ 163.00	BX
	740-1836	18 inches wide by 36 inches high	\$ 191.00	BX
	740-2430	24 inches wide by 30 inches high	\$ 194.00	
	740-2436	24 inches wide by 36 inches high	\$ 197.00	BX
 <p>7405 FIXED TILT MIRROR WITH SHELF</p>	7405-1830	18 inches wide by 30 inches high	\$ 220.00	
	7405-1836	18 inches wide by 36 inches high	\$ 233.00	
	7405-2430	24 inches wide by 30 inches high	\$ 241.00	
	7405-2436	24 inches wide by 36 inches high	\$ 269.00	
 <p>782 ADJUSTABLE TILT STAINLESS STEEL FRAMED MIRROR</p>	782-1624	16 inches wide by 24 inches high	\$ 98.00	
	782-1630	16 inches wide by 30 inches high	\$ 112.00	
	782-1824	18 inches wide by 24 inches high	\$ 113.00	
	782-1830	18 inches wide by 30 inches high	\$ 114.00	
	782-1836	18 inches wide by 36 inches high	\$ 132.00	
	782-2436	24 inches wide by 36 inches high	\$ 149.00	
<p>747 FRAMELESS MIRROR</p>	747-2436	24 inches wide by 36 inches high	\$ 66.00	BX
	Maximum Size: 48" x 72" or 72" x 48"			
 <p>747F FROSTED FRAMELESS MIRROR</p>	747F-018300S	18 inches wide by 30 inches high-Solid Border	\$ 156.00	
	747F-018360S	18 inches wide by 36 inches high-Solid Border	\$ 191.00	
	747F-024360S	24 inches wide by 36 inches high-Solid Border	\$ 233.00	
	747F-018300P	18 inches wide by 30 inches high-Plaid Border	\$ 156.00	
	747F-018360P	18 inches wide by 36 inches high-Plaid Border	\$ 191.00	
	747F-024360P	24 inches wide by 36 inches high-Plaid Border	\$ 233.00	
 <p>748 FRAMELESS STAINLESS STEEL MIRROR #8 ARCHIT. GRADE FINISH 304 STAINLESS STEEL</p>	748-1624	16 inches wide by 24 inches high	\$ 109.00	
	748-1824	18 inches wide by 24 inches high	\$ 118.00	
	748-1836	18 inches wide by 36 inches high	\$ 166.00	
	748-2436	24 inches wide by 36 inches high	\$ 203.00	
Maximum Size: 72" x 47-1/2" or 47-1/2" x 72"				
 <p>7481 FRAMELESS STAINLESS STEEL MIRROR TYPE 430 BRIGHT ANNEALED</p>	7481-1624	16 inches wide by 24 inches high	\$ 95.00	
	7481-1824	18 inches wide by 24 inches high	\$ 99.00	
	7481-1830	18 inches wide by 30 inches high	\$ 110.00	
	7481-1836	18 inches wide by 36 inches high	\$ 121.00	
	7481-2436	24 inches wide by 36 inches high	\$ 146.00	
Maximum Size: 72" x 47-1/2" or 47-1/2" x 72"				

Prices subject to change without notice.
 Items may be changed or discontinued without notice
 and without incurring obligation.



Washroom Accessories Division

TEL: 1-800-BRADLEY FAX: 262-251-5817

Web Site: www.bradleycorp.com

Effective Date February 1, 2017

Series 700 - Stainless Steel Shelves

	Model No.	Description	Shipping Data		Price Each \$	
			Cu. Ft.	Wt. Lbs.		
755 STAINLESS STEEL SHELF - 5" DEPTH	755-12	5" Depth x 12" Length	0.5	1.99	\$ 37.00	
	755-16	5" Depth x 16" Length	0.5	3.00	\$ 38.00	
	755-18	5" Depth x 18" Length	0.5	3.46	\$ 38.00	BX
	755-24	5" Depth x 24" Length	0.5	2.95	\$ 40.00	
756 STAINLESS STEEL SHELF - 6" DEPTH	756-18	6" Depth x 18" Length	0.5	2.63	\$ 54.00	
	756-24	6" Depth x 24" Length	0.5	3.34	\$ 66.00	
758 STAINLESS STEEL SHELF - 8" DEPTH	758-16	8" Depth x 16" Length	0.5	3.14	\$ 61.00	
	758-24	8" Depth x 24" Length	0.5	4.00	\$ 70.00	BX
7510 STAINLESS STEEL SHELF - 10" DEPTH		12" to 112" Lengths Available			Custom	
7512 STAINLESS STEEL SHELF - 12" DEPTH		12" to 112" Lengths Available			Custom	
760 RECESSED SHELF, STAINLESS STEEL	760	Recessed Shelf, Stainless Steel	0.7	5.00	\$ 96.00	
 790 PULL-DOWN UTILITY SHELF HEAVY-DUTY ZAMAC CONSTRUCTION	790	Pull Down Utility Shelf, Heavy Duty Zamac Construction	0.06	4.00	\$ 75.00	

Prices subject to change without notice.
 Items may be changed or discontinued without notice
 and without incurring obligation.



Washroom Accessories Division

TEL: 1-800-BRADLEY FAX: 262-251-5817
Web Site: www.bradleycorp.com

Effective Date February 1, 2017

HOW TO SPECIFY GRAB BARS

1. Select Series Number (812, 817, 832, etc.)

HEAVY-DUTY SERIES			
Mounting	1 1/2" diameter	1 1/4" diameter	1" diameter
Concealed	812	832	852
Exposed	817	837	857

3. Select Grab Bar Configuration (001, 002, 005, etc.)

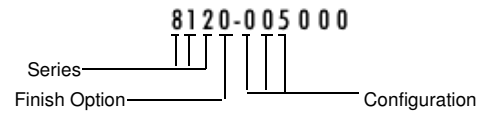

2. Select Finish Option (standard, sanitray safety grip, etc.)

FEATURE	ADD SUFFIX
Standard	0
Safety Grip Finish	2
Bright Polished Finish	4
Safety Grip with Polished Finish	7

4. Select Dimensions Required

- If no modifications are required to the dimensions, an example of the Part No. is:

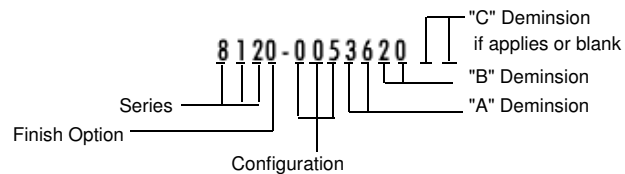

HOW TO MEASURE A GRAB BAR

All Grab Bar Configurations are specified using centerline to centerline dimensions

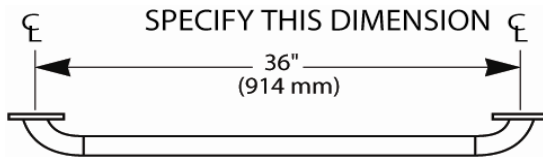

DO NOT SPECIFY THIS DIMENSION

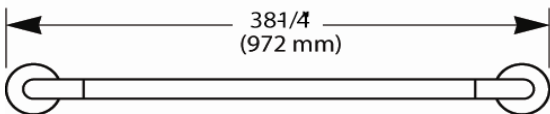

If wall dimensions are given:

- To obtain length of side bars, take clearance (11/2") plus 1/2 of diameter of Grab Bar Series plus an additional 2" and subtract from side wall dimension
- To obtain back bar dimension, take clearance (1 1/2") plus 1/2 of diameter of Grab Bar Series and subtract twice from back wall dimension

Example: 812 Series. If wall dimensions are 30" x 58" x 30", bar dimensions would be 25 3/4" x 53 1/2" x 25 3/4".

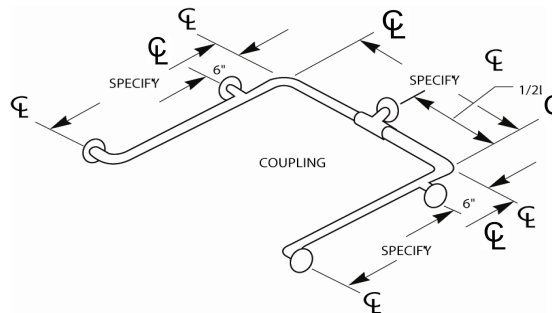

*****Please visit the Washroom Accessories Service Parts price book for information and pricing on grab bar mounting kits**



Washroom Accessories Division

TEL: 1-800-BRADLEY FAX: 262-251-5817

Web Site: www.bradleycorp.com

Effective Date February 1, 2017

GRAB BAR CONFIGURATIONS - 800 SERIES

001

If the grab bar is greater than 54" order Configuration 002 to receive the required center support

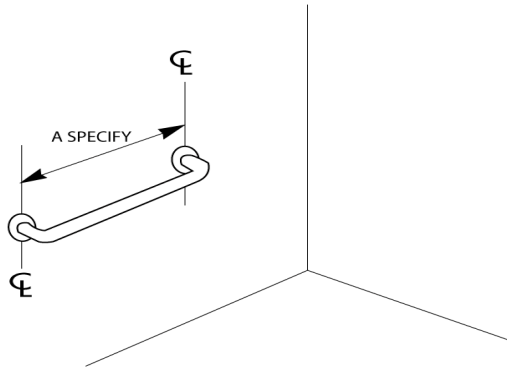

002

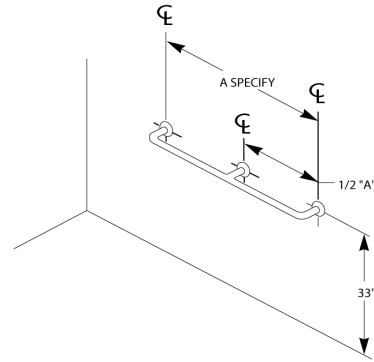

003

Standard length 48", 52", or 54" with center post; only one end return.

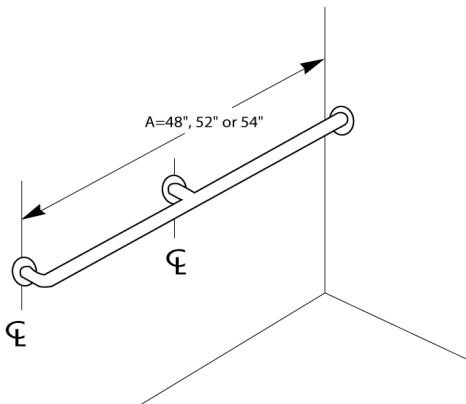

005

"A" dimension will always have stand off.

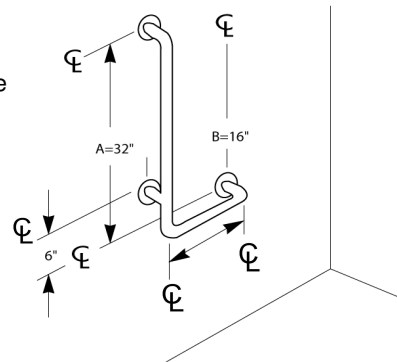

Opposite 005. "A" dimension will always have stand off.

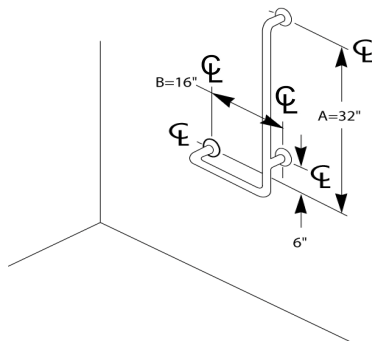

010

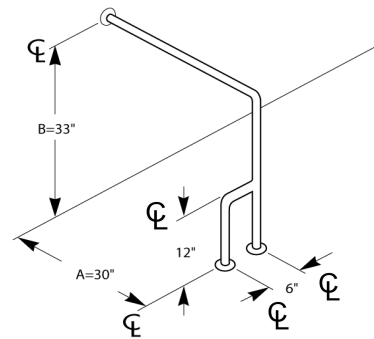



Effective Date February 1, 2017

GRAB BAR CONFIGURATIONS - 800 SERIES (CONTINUED)

011

Opposite 010

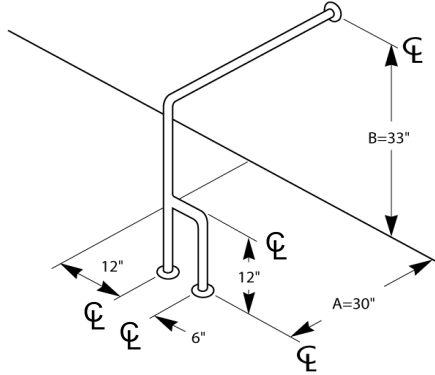

012

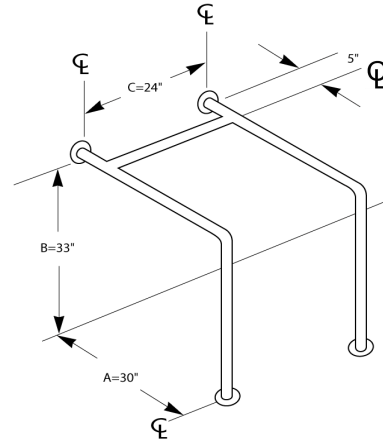

036

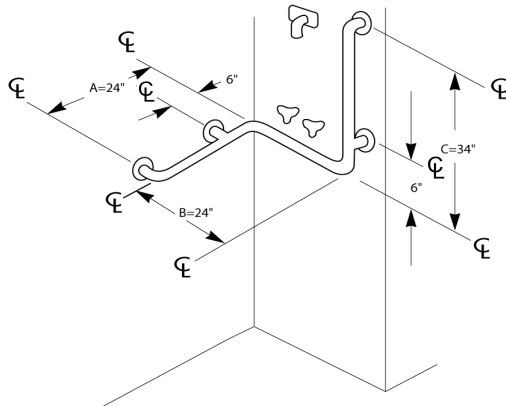

037

Opposite 036

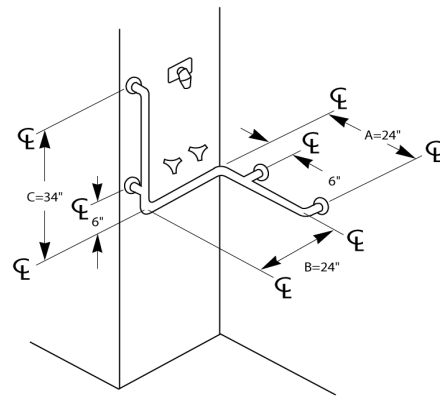

054

30"x33"

Note: 1" tube thickness not available for this application

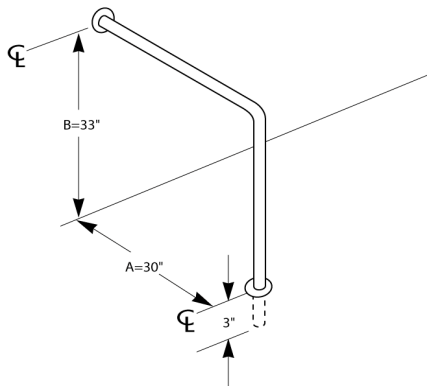

059

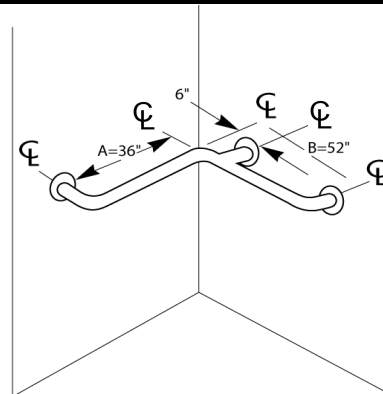



Washroom Accessories Division

TEL: 1-800-BRADLEY FAX: 262-251-5817

Web Site: www.bradleycorp.com

Effective Date February 1, 2017

GRAB BAR CONFIGURATIONS - 800 SERIES (CONTINUED)

060

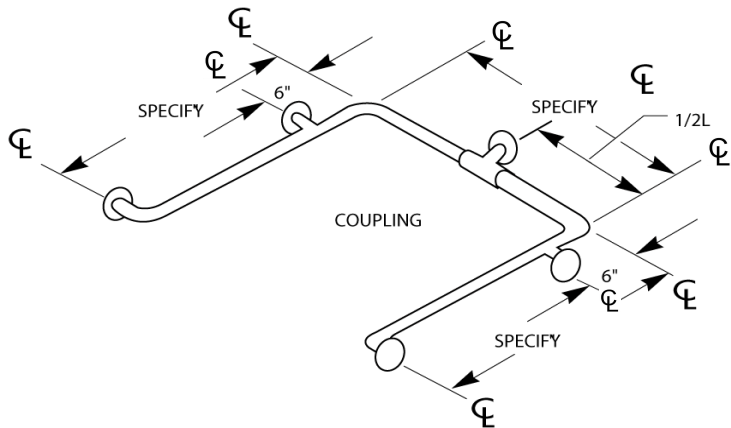

For a complete list of railings, mounting kits, and anchoring devices, please see our technical data catalog.



Washroom Accessories Division

TEL: 1-800-BRADLEY FAX: 262-251-5817

Web Site: www.bradleycorp.com

Effective Date February 1, 2017

SERIES 812 GRAB BARS - 1-1/2" O.D.

Bradley Grab Bars are made of type-304, 18-gauge stainless steel. The exposed surfaces of the seamless constructed Grab Bar are available in an architectural satin (8120 Series), safety grip (8122 Series), bright polished (8124 Series), or safety grip with bright polished (8127 Series) finish. Mounting flanges for the Grab Bars are concealed by snap-on escutcheons.

Config. No.	Description	Shipping Data		(BX)	8120 Series	(BX)	8122 Series	(BX)	8124 Series	(BX)	8127 Series
		Cu. Ft.	Wt. Lbs		Price \$		Price \$		Price \$		Price \$
001120	Grab Bar 1-1/2" OD X 12	0.13	1.22		\$ 26.00		\$ 33.00		Custom		Custom
001160	Grab Bar 1-1/2" OD X 16	0.14	1.46		\$ 27.00		Custom		Custom		Custom
001180	Grab Bar 1-1/2" OD X 18	0.14	1.54	BX	\$ 27.00	BX	\$ 33.00		Custom		Custom
001180AM	Grab Bar 1-1/2" OD X 18, AM	0.14	1.54		\$ 42.00		n/a		n/a		n/a
001240	Grab Bar 1-1/2" OD X 24	0.14	1.99	BX	\$ 30.00	BX	\$ 35.00		Custom		Custom
001240AM	Grab Bar 1-1/2" OD X 24, AM	0.14	1.99		\$ 43.00		n/a		n/a		n/a
001300	Grab Bar 1-1/2" OD X 30	0.15	2.30	BX	\$ 31.00		\$ 38.00		Custom		Custom
001320	Grab Bar 1-1/2" OD X 32	0.15	2.43		\$ 31.00		\$ 38.00		Custom		Custom
001360	Grab Bar 1-1/2" OD X 36	0.15	3.00	BX	\$ 33.00	BX	\$ 39.00		Custom		\$ 72.00
001360AM	Grab Bar 1-1/2" OD X 36, AM	0.15	3.00		\$ 44.00		n/a		n/a		n/a
001400	Grab Bar 1-1/2" OD X 40	0.15	2.94		\$ 33.00		Custom		Custom		Custom
001420	Grab Bar 1-1/2" OD X 42	0.15	3.36	BX	\$ 34.00	BX	\$ 41.00		Custom		\$ 86.00
001420AM	Grab Bar 1-1/2" OD X 42, AM	0.15	3.36		\$ 45.00		n/a		n/a		n/a
001480	Grab Bar 1-1/2" OD X 48	0.25	3.40	BX	\$ 38.00	BX	\$ 42.00		Custom		Custom
001520	Grab Bar 1-1/2" OD X 52	0.25	3.63		\$ 55.00		Custom		Custom		Custom
001540	Grab Bar 1-1/2" OD X 54	0.25	4.03		\$ 57.00		Custom		Custom		Custom
002360	Grab Bar 1-1/2" OD X 36	0.25	2.89		\$ 59.00		Custom		Custom		Custom
002420	Grab Bar 1-1/2" OD X 42	0.25	3.48		\$ 63.00		Custom		Custom		Custom
002480	Grab Bar 1-1/2" OD X 48	0.25	3.78		\$ 68.00		\$ 85.00		Custom		Custom
002540	Grab Bar 1-1/2" OD X 54	0.29	4.04		\$ 89.00		Custom		Custom		Custom
003480	Grab Bar 1-1/2" OD X 48	0.25	3.18		\$ 69.00		Custom		Custom		Custom
003520	Grab Bar 1-1/2" OD X 52	0.29	3.93		\$ 71.00		\$ 94.00		Custom		Custom
003540	Grab Bar 1-1/2" OD X 54	0.29	4.04		\$ 73.00		Custom		Custom		Custom
004000	Grab Bar 1-1/2"OD X 12 X 12	0.62	3.00		\$ 61.00		\$ 85.00		\$ 94.00		\$ 90.00
005000	Grab Bar 1-1/2" OD X 32 X 16	1.10	3.68		\$ 79.00		\$ 101.00		\$ 117.00		\$ 137.00
006000	Grab Bar 1-1/2" OD X 32 X 16	1.10	3.74		\$ 79.00		\$ 101.00		\$ 117.00		\$ 137.00
007000	Grab Bar 1-1/2" OD X 34X25X34	2.30	9.00		\$ 130.00		\$ 168.00		Custom		Custom
010000	Grab Bar 1-1/2" OD X 30 X 33	1.10	5.30		\$ 116.00		\$ 148.00		Custom		\$ 243.00
011000	Grab Bar 1-1/2" OD X 30 X 33	1.10	5.37		\$ 116.00		\$ 147.00		\$ 188.00		\$ 243.00
012000	Grab Bar 1-1/2"ODX30X33X24	6.30	11.00		\$ 190.00		\$ 207.00		Custom		\$ 335.00
022000	Grab Bar 1-1/2"OD X 40 X 32	1.55	7.00		\$ 124.00		Custom		Custom		Custom
023000	Grab Bar 1-1/2"OD X 40 X 32	1.55	7.00		\$ 124.00		Custom		Custom		Custom
024000	Grab Bar 1-1/2"OD X 40, Tub	1.20	7.00		\$ 179.00		\$ 208.00		Custom		Custom

Notes:

Custom: These are Custom order Grab Bars. Please contact customer service for a quotation.

For information on other available sizes, options, and prices not listed on this page please contact your local Sales Representative or Customer Service.

Prices subject to change without notice.
Items may be changed or discontinued without notice and without incurring obligation.



Washroom Accessories Division

TEL: 1-800-BRADLEY FAX: 262-251-5817
 Web Site: www.bradleycorp.com

Effective Date February 1, 2017

SERIES 812 GRAB BARS - 1-1/2" O.D. (CONTINUED)

Bradley Grab Bars are made of type-304, 18-gauge stainless steel. The exposed surfaces of the seamless constructed Grab Bar are available in an architectural satin (8120 Series), safety grip (8122 Series), bright polished (8124 Series), or safety grip with bright polished (8127 Series) finish. Mounting flanges for the Grab Bars are concealed by snap-on escutcheons.

Config. No.	Description	Shipping Data		(BX)	8120 Series	(BX)	8122 Series	(BX)	8124 Series	(BX)	8127 Series
		Cu. Ft.	Wt. Lbs		Price \$		Price \$		Price \$		Price \$
026000	Grab Bar 1-1/2"OD X 40, Tub	0.90	5.00		\$ 121.00		Custom		Custom		Custom
027000	Grab Bar 1-1/2"OD X 40, Tub	0.90	5.00		\$ 121.00		\$ 150.00		Custom		Custom
030000	Grab Bar 1-1/2"ODX36X20X24	6.10	8.00		\$ 135.00		\$ 155.00		Custom		Custom
031000	Grab Bar 1-1/2"ODX36X20X24	6.10	8.00		\$ 135.00		\$ 156.00		Custom		Custom
032000	Grab Bar 1-1/2"OD X 24 X 34	1.45	6.00		\$ 97.00		\$ 112.00		\$ 173.00		\$ 172.00
033000	Grab Bar 1-1/2"OD X 24 X 34	1.45	6.00		\$ 97.00		\$ 112.00		Custom		Custom
034000	Grab Bar 1-1/2"ODX26X26X24	5.85	7.00		\$ 155.00		\$ 191.00		Custom		\$ 279.00
035000	Grab Bar 1-1/2"ODX26X26X24	5.85	7.00		\$ 155.00		\$ 198.00		Custom		\$ 279.00
036000	Grab Bar 1-1/2"ODX24X24X34	5.85	8.00		\$ 130.00		\$ 156.00		Custom		Custom
037000	Grab Bar 1-1/2"ODX24X24X34	5.85	5.88		\$ 130.00		\$ 156.00		Custom		Custom
039000	Grab Bar 1-1/2"ODX28X22X22	8.70	11.10		\$ 151.00		\$ 185.00		Custom		Custom
039100	Grab Bar 1-1/2"ODX28X22X22	1.00	10.00		\$ 115.00		\$ 143.00		Custom		Custom
040000	Grab Bar 1-1/2"OD X 32 X 9	0.95	5.00		\$ 61.00		\$ 73.00		Custom		Custom
041000	Grab Bar 1-1/2"OD X 32 X 9	0.95	5.00		\$ 61.00		\$ 73.00		Custom		Custom
048160	Grab Bar 1-1/2" OD X 16, RH	0.14	1.46		\$ 38.00		Custom		Custom		Custom
048240	Grab Bar 1-1/2" OD X 24, RH	0.14	1.99		\$ 42.00		\$ 51.00		Custom		Custom
048280	Grab Bar 1-1/2" OD X 28, RH	0.18	2.27		\$ 44.00		Custom		Custom		Custom
048360	Grab Bar 1-1/2" OD X 36, RH	0.15	3.00		\$ 57.00		Custom		Custom		Custom
048420	Grab Bar 1-1/2" OD X 42, RH	0.15	3.36		\$ 61.00		\$ 63.00		Custom		Custom
048540	Grab Bar 1-1/2" OD X 54, RH	0.25	4.03		\$ 64.00		Custom		Custom		Custom
049180	Grab Bar 1-1/2" OD X 18, LH	0.14	1.54		\$ 44.00		Custom		Custom		Custom
049320	Grab Bar 1-1/2" OD X 32, LH	0.15	2.43		\$ 55.00		Custom		Custom		Custom
054000	Grab Bar 1-1/2" OD, 30 X 33	1.10	4.40		\$ 64.00		\$ 82.00		\$ 112.00		\$ 125.00
055000	Grab Bar 1-1/2" OD, 24 X 24	1.40	3.30		\$ 69.00		\$ 82.00		Custom		Custom
056000	Grab Bar 1-1/2" OD, 18X33X27	1.28	9.00		\$ 131.00		\$ 240.00		Custom		Custom
059000	Grab Bar 1-1/2" OD X 40 X 52	4.63	6.54	BX	\$ 109.00		\$ 141.00		\$ 174.00		\$ 210.00
0591530	Grab Bar 1-1/2" OD X 15 X 30	1.19	3.38		\$ 89.00		\$ 109.00		Custom		Custom
0591830	Grab Bar 1-1/2" OD X 18 X 30	1.97	3.74		\$ 90.00		\$ 111.00		Custom		\$ 161.00

Notes:

Custom: These are Custom order Grab Bars. Please contact customer service for a quotation.

The 001 style Grab Bar can be ordered in lieu of a corridor railing if the length is less than 54" in length.

For information on other available sizes, options, and prices not listed on this page please contact your local Sales Representative or Customer Service.

Prices subject to change without notice.
 Items may be changed or discontinued without notice
 and without incurring obligation.



Washroom Accessories Division

TEL: 1-800-BRADLEY FAX: 262-251-5817
 Web Site: www.bradleycorp.com

Effective Date February 1, 2017

SERIES 812 GRAB BARS - 1-1/2" O.D. (CONTINUED)

Bradley Grab Bars are made of type-304, 18-gauge stainless steel. The exposed surfaces of the seamless constructed Grab Bar are available in an architectural satin (8120 Series), safety grip (8122 Series), bright polished (8124 Series), or safety grip with bright polished (8127 Series) finish. Mounting flanges for the Grab Bars are concealed by snap-on escutcheons.

Config. No.	Description	Shipping Data		(BX)	8120 Series	(BX)	8122 Series	(BX)	8124 Series	(BX)	8127 Series
		Cu. Ft.	Wt. Lbs		Price \$		Price \$		Price \$		Price \$
0591836	Grab Bar 1-1/2" OD X 18 X 36	1.69	3.88		\$ 97.00		\$ 115.00		Custom		\$ 172.00
0592436	Grab Bar 1-1/2" OD X 24 X 36	2.04	4.44		\$ 98.00		\$ 117.00		\$ 152.00		\$ 180.00
0593652	Grab Bar 1-1/2" OD X 36 x 52	4.04	6.29		\$ 104.00		\$ 133.00		Custom		Custom
0593654	Grab Bar 1-1/2" OD X 36 X 54	4.34	6.16		\$ 98.00		\$ 142.00		Custom		\$ 219.00
0594254	Grab Bar 1-1/2" OD X 42 X 54	4.34	6.55		\$ 109.00		\$ 147.00		Custom		Custom
060306030	Grab Bar 1-1/2" OD 30 X 60 X30	4.44	9.50		\$ 241.00		\$ 312.00		Custom		\$ 427.00
060366036	Grab Bar 1-1/2" OD 36 X 60 X36	4.44	9.80		\$ 249.00		\$ 321.00		Custom		Custom
115000	Grab Bar 1-1/2" OD 16 X 24 X 12	1.20	6.00		\$ 143.00		\$ 180.00		Custom		\$ 276.00
116000	Grab Bar 1-1/2" OD 16 X 24 X 12	1.20	6.00		\$ 143.00		\$ 184.00		Custom		Custom
117000	Grab Bar 1-1/2" OD 16 X 24 X 24	1.30	8.87		\$ 209.00		\$ 270.00		Custom		\$ 329.00
118000	Grab Bar 1-1/2" OD 16 X 24 X 24	0.95	11.00		\$ 218.00		\$ 282.00		Custom		Custom
119000	Grab Bar 1-1/2" OD 16 X 24 X 28	2.20	7.00		\$ 143.00		\$ 184.00		Custom		Custom
120000	Grab Bar 1-1/2" OD 16 X 24 X 28	2.20	7.00		\$ 147.00		\$ 184.00		Custom		Custom

Notes:

Custom: These are Custom order Grab Bars. Please contact customer service for a quotation.

The 001 style Grab Bar can be ordered in lieu of a corridor railing if the length is less than 54" in length.

For information on other available sizes, options, and prices not listed on this page please contact your local Sales Representative or Customer Service.



Washroom Accessories Division

TEL: 1-800-BRADLEY FAX: 262-251-5817

Web Site: www.bradleycorp.com

Effective Date February 1, 2017

812 SERIES GRAB BAR MULTI PACKS

The packaging style pictured below is ideal for anyone who needs to warehouse Bradley Grab Bars. This convenient stocking option is available in the sizes below, pre-packaged in quantities of 10 or 20 Grab Bars. All Grab Bars inside the master carton are of the same length and are individually packaged in a plastic bag with a label.

When the product arrives at your location, cut off the end where it states to 'Cut Here', and the grab bars can be easily organized and accessed when needed.

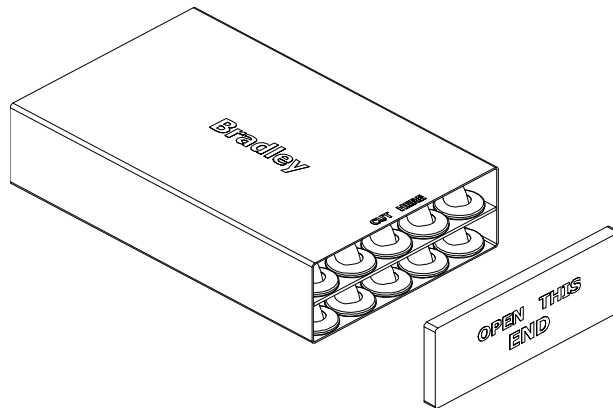

10 Pack Pictured

10-Pack Master Carton		Shipping Data		Price Each \$
Model No.	Cu. Ft.	Wt. Lbs.	(BX)	
8120-001180-10	1.66	18.79		\$ 263.00
8122-001180-10	1.66	18.79		\$ 325.00
8120-001240-10	1.66	22.59		\$ 294.00
8122-001240-10	1.66	22.59		\$ 347.00
8120-001300-10	2.40	25.56		\$ 305.00
8122-001300-10	2.40	25.56		\$ 378.00
8120-001360-10	2.40	30.46	BX	\$ 325.00
8122-001360-10	2.40	30.46		\$ 389.00
8120-001420-10	3.14	37.67	BX	\$ 337.00
8122-001420-10	3.14	37.67		\$ 410.00
8120-001480-10	3.14	40.97		\$ 378.00
8122-001480-10	3.14	40.97		\$ 420.00

20-Pack Master Carton		Shipping Data		Price Each \$
Model No.	Cu. Ft.	Wt. Lbs.		
8120-001180-20	3.36	37.35		\$ 525.00
8122-001180-20	3.36	37.35		\$ 652.00
8120-001240-20	3.36	44.95		\$ 589.00
8122-001240-20	3.36	44.95		\$ 694.00
8120-001300-20	4.85	51.78		\$ 609.00
8122-001300-20	4.85	51.78		\$ 757.00
8120-001360-20	4.85	61.58		\$ 652.00
8122-001360-20	4.85	61.58		\$ 777.00
8120-001420-20	6.34	72.92		\$ 672.00
8122-001420-20	6.34	72.92		\$ 819.00
8120-001480-20	6.34	79.52		\$ 757.00
8122-001480-20	6.34	79.52		\$ 840.00

Prices subject to change without notice.
 Items may be changed or discontinued without notice
 and without incurring obligation.



Washroom Accessories Division

TEL: 1-800-BRADLEY FAX: 262-251-5817

Web Site: www.bradleycorp.com

Effective Date February 1, 2017

SERIES 817 GRAB BARS - 1-1/2" O.D.

Bradley Grab Bars are made of type-304, 18-gauge stainless steel. The exposed surfaces of the seamless constructed Grab Bar are available in an architectural satin (8170 Series), safety grip (8172), or safety grip with bright polished (8177 Series) finish. The mounting flanges for the 817 grab bars are exposed.

Config. No.	Description	Shipping Data		(BX)	8170 Series	(BX)	8172 Series	(BX)	8177 Series
		Cu. Ft.	Wt. Lbs		Price \$		Price \$		Price \$
001120	Grab Bar 1-1/2" OD X 12	0.13	1.28		\$ 27.00		\$ 34.00		Custom
001180	Grab Bar 1-1/2" OD X 18	0.14	1.58		\$ 30.00		\$ 37.00		Custom
001240	Grab Bar 1-1/2" OD X 24	0.14	1.99		\$ 31.00		\$ 39.00		Custom
001300	Grab Bar 1-1/2" OD X 30	0.15	2.30		\$ 31.00		\$ 42.00		Custom
001320	Grab Bar 1-1/2" OD X 32	0.15	2.43		\$ 32.00		Custom		Custom
001360	Grab Bar 1-1/2" OD X 36	0.15	2.60	BX	\$ 33.00		\$ 42.00		Custom
001420	Grab Bar 1-1/2" OD X 42	0.15	3.07	BX	\$ 34.00		\$ 50.00		Custom
001480	Grab Bar 1-1/2" OD X 48	0.25	3.38		\$ 43.00		\$ 55.00		Custom
002480	Grab Bar 1-1/2" OD X 48	0.25	3.61		\$ 66.00		Custom		Custom
003520	Grab Bar 1-1/2" OD X 52	0.29	5.00		\$ 78.00		Custom		Custom
048420	Grab Bar 1-1/2"OD X 42, RH	0.15	3.07		\$ 58.00		Custom		Custom
054000	Grab Bar 1-1/2" OD X 30 X 33	0.15	4.60		\$ 69.00		\$ 89.00		Custom
158000	Swing-Away Grab Bar 1-1/2 OD	2.75	15.31		\$365.00		\$442.00		Custom
158100	Swing-Away Grab Bar 1-1/2 OD	2.75	16.15		\$456.00		\$534.00		Custom

Notes:

Custom: These are Custom order Grab Bars. Please contact customer service for a quotation.

The 001 style Grab Bar can be ordered in lieu of a corridor railing if the length is less than 54".

For information on other available sizes, options, and prices not listed on this page please contact your local Sales Representative or customer service.



Washroom Accessories Division

TEL: 1-800-BRADLEY FAX: 262-251-5817

Web Site: www.bradleycorp.com

Effective Date February 1, 2017

SERIES 832 GRAB BARS - 1-1/4" O.D.

Bradley Grab Bars are made of type-304, 18-gauge stainless steel. The exposed surfaces of the seamless constructed Grab Bar are available in an architectural satin (8320 Series), safety grip (8322 Series), bright polished (8324 Series), or safety grip with bright polished (8327 Series) finish. Mounting flanges for the Grab Bars are concealed by snap-on escutcheons

Config. No.	Description	Shipping Data		(BX)	8320 Series	(BX)	8322 Series	(BX)	8324 Series	(BX)	8327 Series
		Cu. Ft.	Wt. Lbs.		Price \$		Price \$		Price \$		Price \$
001120	Grab Bar 1-1/4"OD X 12	0.13	1.18		\$ 26.00		\$ 31.00		Custom		\$ 57.00
001180	Grab Bar 1-1/4"OD X 18	0.14	1.46	BX	\$ 26.00		\$ 32.00		Custom		Custom
001240	Grab Bar 1-1/4" OD X 24	0.14	1.79	BX	\$ 27.00	BX	\$ 33.00		Custom		\$ 62.00
001300	Grab Bar 1-1/4"OD X 30	0.15	2.03		\$ 27.00		\$ 33.00		Custom		Custom
001320	Grab Bar 1-1/4"OD X 32	0.15	2.15		\$ 29.00		Custom		Custom		Custom
001360	Grab Bar 1-1/4" OD X 36	0.15	2.43	BX	\$ 30.00	BX	\$ 34.00		Custom		\$ 73.00
001420	Grab Bar 1-1/4" OD X 42	0.15	2.81	BX	\$ 32.00	BX	\$ 35.00		Custom		\$ 79.00
001480	Grab Bar 1-1/4" OD X 48	0.25	3.01	BX	\$ 34.00		\$ 45.00		Custom		\$ 82.00
002480	Grab Bar 1-1/4"OD X 48	0.25	3.22		\$ 62.00		\$ 82.00		Custom		Custom
004000	Grab Bar 1-1/4"OD X 12 X 12	0.62	3.00		\$ 51.00		\$ 57.00		\$ 79.00		\$ 79.00
005000	Grab Bar 1-1/4"OD X 32 X 16	1.10	5.00		\$ 70.00		\$ 72.00		Custom		\$ 121.00
006000	Grab Bar 1-1/4"OD X 32 X 16	1.10	5.00		\$ 70.00		\$ 87.00		\$150.00		\$ 121.00
007000	Grab Bar 1-1/4"OD X 34X25X34,	1.10	5.00		\$ 135.00		\$149.00		Custom		Custom
010000	Grab Bar 1-1/4"OD X 30 X 33	1.10	5.00		\$ 112.00		\$125.00		Custom		\$ 192.00
011000	Grab Bar 1-1/4"OD X 30 X 33	1.10	5.00		\$ 112.00		\$125.00		Custom		\$ 192.00
012000	Grab Bar 1-1/4"OD X 30 X 33	6.30	10.00		\$ 189.00		\$212.00		Custom		Custom
030000	Grab Bar 1-1/4"OD X 36 X 20 X 24	6.10	7.00		\$ 142.00		\$155.00		Custom		\$ 256.00
031000	Grab Bar 1-1/4"OD X 36 X 20 X 24	6.10	8.00		\$ 142.00		\$145.00		Custom		Custom
032000	Grab Bar 1-1/4"ODX24X34 SHWR	1.45	5.00		\$ 91.00		\$ 98.00		Custom		Custom
033000	Grab Bar 1-1/4"ODX24X34 SHWR	1.45	5.00		\$ 91.00		\$ 98.00		\$133.00		Custom
036000	Grab Bar 1-1/4"ODX24X24X34	17.42	5.05		\$ 155.00		\$146.00		\$181.00		Custom
037000	Grab Bar 1-1/4"ODX24X24X34	17.42	5.05		\$ 155.00		\$146.00		Custom		Custom
039000	Grab Bar 1-1/4"ODX28X28X22	8.70	15.00		\$ 152.00		\$169.00		Custom		Custom
040000	Grab Bar 1-1/4"OD X 32 X 9	0.95	4.00		\$ 58.00		\$ 64.00		\$ 77.00		Custom
041000	Grab Bar 1-1/4"OD X 32 X 9	0.95	4.00		\$ 58.00		\$ 64.00		\$ 77.00		Custom
048240	Grab Bar 1-1/4"OD X 24, RH	0.14	1.79		\$ 49.00		Custom		Custom		Custom

Notes:

Custom: These are Custom order Grab Bars. Please contact customer service for a quotation.

The 001 style Grab Bar can be ordered in lieu of a corridor railing if the length is less than 54".

For information on other available sizes, options, and prices not listed on this page please contact your local Sales Representative or Customer Service.

Prices subject to change without notice.
Items may be changed or discontinued without notice and without incurring obligation.



Washroom Accessories Division

TEL: 1-800-BRADLEY FAX: 262-251-5817

Web Site: www.bradleycorp.com

Effective Date February 1, 2017

SERIES 832 GRAB BARS - 1-1/4" O.D. (CONTINUED)

Bradley Grab Bars are made of type-304, 18-gauge stainless steel. The exposed surfaces of the seamless constructed Grab Bar are available in an architectural satin (8320 Series), safety grip (8322 Series), bright polished (8324 Series), or safety grip with bright polished (8327 Series) finish. Mounting flanges for the Grab Bars are concealed by snap-on escutcheons

Config. No.	Description	Shipping Data		(BX)	8320 Series	(BX)	8322 Series	(BX)	8324 Series	(BX)	8327 Series
		Cu. Ft.	Wt. Lbs		Price \$		Price \$		Price \$		Price \$
048360	Grab Bar 1-1/4"OD X 36, RH,	0.15	2.43		\$ 54.00		Custom		Custom		Custom
049160	Grab Bar 1-1/4"OD X 16, LH,	0.14	1.79		\$ 44.00		Custom		Custom		Custom
049240	Grab Bar 1-1/4"OD X 24, LH,	0.14	1.79		\$ 61.00		Custom		Custom		\$ 62.00
054000	Grab Bar 1-1/4"OD X 30 X 33	1.10	3.89		\$ 62.00		\$ 73.00		Custom		Custom
055000	Grab Bar 1-1/4"OD X 24 X 24	1.37	3.45		\$ 68.00	BX	\$ 55.00		Custom		Custom
057000	Grab Bar 1-1/4"OD X 30 X 30	2.17	2.75		\$ 74.00		\$ 108.00		Custom		Custom
059000	Grab Bar 1-1/4"OD X 40 X 52	4.59	5.69		\$ 100.00		\$ 126.00		Custom		\$ 196.00
0591830	Grab Bar 1-1/4"OD X 18 X 30	2.00	3.20		\$ 84.00		\$ 106.00		Custom		\$ 171.00
0592436	Grab Bar 1-1/4"OD X 24 X 36	2.00	4.02		\$ 91.00		\$ 113.00		Custom		\$ 184.00
0593652	Grab Bar 1-1/4"OD X 36 X 52	4.07	5.48		\$ 111.00		\$ 131.00		Custom		Custom
0593654	Grab Bar 1-1/4"OD X 36 X 54	4.26	5.24		\$ 104.00		\$ 131.00		Custom		\$ 207.00
0594254	Grab Bar 1-1/4"OD X 42 X 54	4.89	5.93		\$ 110.00		\$ 138.00		Custom		Custom
117000	Grab Bar 1-1/4" OD X 16 X 24	1.30	10.00		\$ 205.00		\$ 265.00		Custom		Custom
118000	Grab Bar 1-1/4" OD X 16 X 24	0.95	10.00		\$ 205.00		\$ 265.00		Custom		Custom

Notes:

Custom: These are Custom order Grab Bars. Please contact customer service for a quotation.

The 001 style Grab Bar can be ordered in lieu of a corridor railing if the length is less than 54".

For information on other available sizes, options, and prices not listed on this page please contact your local Sales Representative or Customer Service.



Washroom Accessories Division

TEL: 1-800-BRADLEY FAX: 262-251-5817
 Web Site: www.bradleycorp.com

Effective Date February 1, 2017

SERIES 837 GRAB BARS - 1-1/4" O.D.

Bradley Grab Bars are made of type-304, 18-gauge stainless steel. The exposed surfaces of the seamless constructed grab bar are available in an architectural satin (8370 Series), safety grip (8372), bright polished (8374), or safety grip with bright polished (8377 Series) finish. The mounting flanges for the 837 Grab Bars are exposed.

Config. No.	Description	Shipping Data		(BX)	8370 Series	(BX)	8372 Series	(BX)	8374 Series	(BX)	8377 Series
		Cu. Ft.	Wt. Lbs		Price \$		Price \$		Price \$		Price \$
001240	Grab Bar 1-1/4"OD X 24	0.14	1.73		\$ 31.00		\$ 38.00		Custom		Custom
001300	Grab Bar 1-1/4"OD X 30	0.15	2.00		\$ 33.00		Custom		Custom		Custom
001360	Grab Bar 1-1/4"OD X 36	0.15	2.41		\$ 33.00		\$ 41.00		Custom		Custom
001420	Grab Bar 1-1/4"OD X 42	0.15	2.69		\$ 37.00		\$ 45.00		Custom		Custom
001480	Grab Bar 1-1/4"OD X 48	0.25	3.11		\$ 39.00		\$ 51.00		Custom		Custom
048480	Grab Bar 1-1/4"OD X 48, RH	0.25	3.11		\$ 51.00		Custom		Custom		Custom
054000	Grab Bar 1-1/4"ODX30X33	1.10	6.00		\$ 68.00		Custom		Custom		Custom
055000	Grab Bar 1-1/4"ODX24X24	0.64	7.00		Custom		\$ 80.00		Custom		Custom
060306030	Grab Bar 1-1/4"ODX30X60X30	4.44	9.50		\$ 277.00		Custom		Custom		Custom
101000	Swing Up Grab Bar, 1-1/4"OD	1.35	7.80	BX	\$ 276.00	BX	\$ 289.00		Custom		Custom
102000	Swing Up Grab Bar, 1-1/4"OD	1.35	9.00	BX	\$ 310.00		\$ 325.00		Custom		Custom
103000	Swing Up Grab Bar, 1-1/4"OD	1.35	9.00	BX	\$ 340.00		\$ 356.00		Custom		Custom

Notes:

Custom: These are Custom order Grab Bars. Please contact customer service for a quotation.

The 001 style grab bar can be ordered in lieu of a corridor railing if the length is less than 54".

For information on other available sizes, options, and prices not listed on this page please contact your local Sales Representative or Customer Service.



Washroom Accessories Division

TEL: 1-800-BRADLEY FAX: 262-251-5817
 Web Site: www.bradleycorp.com

Effective Date February 1, 2017

SERIES 852 GRAB BARS - 1" O.D.

Bradley Grab Bars are made of type-304, 22-gauge stainless steel. The exposed surfaces of the seamless constructed Grab Bar are available in an architectural satin (8520 Series), safety grip (8522), bright polished (8524), or safety grip with bright polished (8527 Series) finish.

Config. No.	Description	Shipping Data		(BX)	8520 Series	(BX)	8522 Series	(BX)	8524 Series	(BX)	8527 Series
		Cu. Ft.	Wt. Lbs		Price \$		Price \$		Price \$		Price \$
001180	BX-Grab Bar 1" OD X 18	0.14	1.32	BX	\$ 36.00		Custom		Custom		Custom
001240	BX-Grab Bar 1" OD X 24	0.14	1.63	BX	\$ 37.00		Custom		Custom		Custom
001360	** Grab Bar 1" OD X 36	0.15	1.96		\$ 43.00		\$ 58.00		Custom		Custom
001420	** Grab Bar 1" OD X 42	0.15	2.42		\$ 45.00		Custom		Custom		Custom

SERIES 857 GRAB BARS - 1" O.D.

Bradley Grab Bars are made of type-304, 18-gauge stainless steel. The exposed surfaces of the seamless constructed grab bar are available in an architectural satin (8570 Series), safety grip (8572), bright polished (8574), or safety grip with bright polished (8577 Series) finish.

Config. No.	Description	Shipping Data		(BX)	8570 Series	(BX)	8572 Series	(BX)	8574 Series	(BX)	8577 Series
		Cu. Ft.	Wt. Lbs		Price \$		Price \$		Price \$		Price \$
001420	** Grab Bar 1" OD X 42	1.1	5.00		\$ 78.00		Custom		Custom		Custom

Notes:

Custom: These are Custom order Grab Bars. Please contact customer service for a quotation.

The 001 style Grab Bar can be ordered in lieu of a corridor railing if the length is less than 54".

For information on other available sizes, options, and prices not listed on this page please contact your local Sales Representative or Customer Service.









Washroom Accessories Division

TEL: 1-800-BRADLEY FAX: 262-251-5817

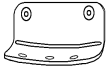
Web Site: www.bradleycorp.com

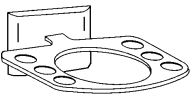
Effective Date February 1, 2017

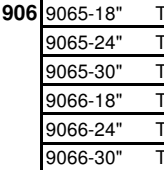
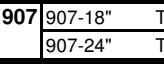
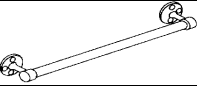
Series 900 - Hotel, Hospital/Patient Care, Custodial Accessories

	Model No.	Description	Shipping Data		Price Each \$	
			Cu. Ft.	Wt. Lbs.		
	900	900 Soap Dish - Extra Heavy Duty, Stainless Steel	0.2	1.50	\$ 49.00	BX
OPTIONS						
(Model 900)						
	-59	Anchor Plate	Add	0 0.00	*	
	-61	Self Tapping Wood Screws	Add	0 0.00	*	
	901	901 Soap Dish	0.02	0.56	\$ 13.00	
		901-60 Soap Dish with Drain Holes	0.01	0.59	\$ 13.00	
		9014 Soap Dish with Drain Holes - Satin Stainless Steel	0.02	0.40	\$ 8.00	BX
		9014-63 Soap Dish Less Drain Holes - Satin Stainless Steel	0.04	0.33	\$ 13.00	
		9015 Soap Dish with Drain Holes - Bright Polish	0.02	0.43	\$ 10.00	BX
		9015-63 Soap Dish Less Drain Holes - Bright Polish	0.04	0.32	\$ 13.00	
	903	9034 Soap Dish With Bar - Satin Stainless Steel, Horizontal	0.08	0.85	\$ 24.00	
		9035 Soap Dish With Bar - Bright Polish Horizontal	0.07	0.92	\$ 24.00	
	904	9044 Tumbler/Toothbrush Holder - Satin Stainless Steel	0.02	0.35	\$ 7.00	BX
		9045 Tumbler/Toothbrush Holder - Bright Polish	0.02	0.34	\$ 8.00	
	905	9054-18" Towel Bar - Square, Satin Stainless Steel	0.1	0.60	\$ 18.00	BX
		9054-24" Towel Bar - Square, Satin Stainless Steel	0.2	0.66	\$ 19.00	BX
		9054-30" Towel Bar - Square, Satin Stainless Steel	0.2	0.77	\$ 31.00	
		9055-18" Towel Bar - Square, Bright Polish	0.1	0.66	\$ 19.00	BX
		9055-24" Towel Bar - Square, Bright Polish	0.2	0.74	\$ 19.00	BX
	906	9065-18" Towel Bar - Round, Satin Stainless Steel	0.1	0.79	\$ 16.00	BX
		9065-24" Towel Bar - Round, Satin Stainless Steel	0.2	1.91	\$ 18.00	BX
		9065-30" Towel Bar - Round, Satin Stainless Steel	0.2	1.05	\$ 25.00	
		9066-18" Towel Bar - Round, Bright Polish	0.1	0.69	\$ 18.00	BX
		9066-24" Towel Bar - Round, Bright Polish	0.1	1.50	\$ 18.00	BX
		9066-30" Towel Bar - Round, Bright Polish	0.2	0.84	\$ 25.00	
	907	907-18" Towel Bar - Square, Chrome Plated Brass	0.09	1.22	\$ 28.00	
		907-24" Towel Bar - Square, Chrome Plated Brass	0.15	1.32	\$ 30.00	
	908	908-18" Towel Bar - Round, Stainless Steel, Chrome Plated Posts	0.2	1.80	\$ 34.00	
		908-24" Towel Bar - Round, Stainless Steel, Chrome Plated Posts	0.2	2.00	\$ 36.00	BX
		908-30" Towel Bar - Round, Stainless Steel, Chrome Plated Posts	0.3	2.20	\$ 38.00	
	909	9094-18" Shelf - Satin Stainless Steel	0.04	1.12	\$ 34.00	
		9094-24" Shelf - Satin Stainless Steel	0.03	1.39	\$ 37.00	
		9095-18" Shelf - Bright Polish	0.19	1.75	\$ 34.00	
		9095-24" Shelf - Bright Polish	0.03	3.00	\$ 37.00	

Notes *For information on options on this page please contact your local Sales Representative or Customer Service

Prices subject to change without notice.
Items may be changed or discontinued without notice and without incurring obligation.



Washroom Accessories Division

TEL: 1-800-BRADLEY FAX: 262-251-5817

Web Site: www.bradleycorp.com

Effective Date February 1, 2017

Series 900 - Hotel, Hospital/Patient Care, Custodial Accessories

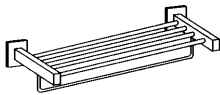
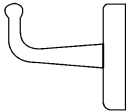
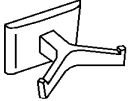
	Model No.	Description	Shipping Data		Price Each \$	
			Cu. Ft.	Wt. Lbs.		
	910 9104-18"	Towel Shelf - Satin Stainless Steel	0.95	3.50	\$ 34.00	
	9104-24"	Towel Shelf - Satin Stainless Steel	0.47	2.04	\$ 40.00	
	9104-2490	Towel Shelf With Bar - Satin Stainless Steel	0.72	2.43	\$ 52.00	
	9105-18"	Towel Shelf - Bright Polish	0.19	0.90	\$ 34.00	
	9105-24"	Towel Shelf - Bright Polish	0.44	2.03	\$ 37.00	
	9105-1890	Towel Shelf With Bar - Bright Polish	0.50	2.03	\$ 44.00	
	9105-2490	Towel Shelf With Bar - Bright Polish	0.58	2.43	\$ 52.00	
	911 911	Single Robe Hook - Brass, Chrome Plated	0.01	0.30	\$ 8.00	
	9111	Single Robe Hook - Stainless Steel	0.01	0.15	\$ 11.00	
	9114	Single Robe Hook - Satin Stainless Steel	0.01	0.21	\$ 6.00	BX
	9115	Single Robe Hook - Bright Polish Stainless Steel	0.01	0.24	\$ 7.00	BX
	9118	Single Robe Hook - Heavy Duty, Chrome Plated	0.02	0.77	\$ 14.00	BX
	9118-81	Single Robe Hook - Heavy Duty, Satin Chrome	0.02	1.00	\$ 14.00	BX
	9119	Single Robe Hook - Heavy Duty, Chrome Plated	0.03	0.51	\$ 15.00	BX
	912 912	Double Robe Hook - Chrome Plated Brass	0.01	0.30	\$ 8.00	BX
	9124	Double Robe Hook - Satin Stainless Steel	0.01	0.33	\$ 8.00	BX
	9125	Double Robe Hook - Bright Polish	0.01	0.31	\$ 8.00	BX
	9134	Hat and Coat Hook - Satin Stainless Steel	0.02	0.41	\$ 12.00	BX
	9135	Hat and Coat Hook - Bright Polish	0.07	0.40	\$ 12.00	BX
914	914	Double Coat Hook - Exposed Mtg., Chrome Plated Brass	0.04	1.00	\$ 10.00	
915	915	Hook and Bumper - Chrome Plated Brass	0.02	1.00	\$ 5.00	BX
916	9164	Bottle Opener - Satin Stainless Steel	0.01	0.10	\$ 7.00	
917	917	Clothes Hook - Exposed Mtg., Stainless Steel	0.01	0.15	\$ 8.00	BX

Notes *For information on options on this page please contact your local Sales Representative or Customer Service







Washroom Accessories Division

TEL: 1-800-BRADLEY FAX: 262-251-5817

Web Site: www.bradleycorp.com

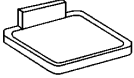
Effective Date February 1, 2017

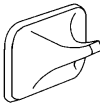
Series 900 - Hotel, Hospital/Patient Care, Custodial Accessories

	Model No.	Description	Shipping Data		Price Each \$	
			Cu. Ft.	Wt. Lbs.		
	921	Soap Dish - Chrome Plated Zamac	1.03	0.31	\$ 6.00	BX
	921-60	Soap Dish with Drain Holes - Chrome Plated Zamac	0.02	0.35	\$ 10.00	
	924	Tumbler/Toothbrush Holder - Chrome Plated Zamac	0.02	0.34	\$ 8.00	
	926	926-18" Towel Bar - Round, Chrome Plated Zamac	0.07	0.69	\$ 14.00	
		926-24" Towel Bar - Round, Chrome Plated Zamac	0.09	0.76	\$ 16.00	
	927	927-18" Towel Bar - Square, Chrome Plated Zamac	0.07	0.55	\$ 8.00	BX
		927-24" Towel Bar - Square, Chrome Plated Zamac	0.09	0.50	\$ 11.00	BX
	930	930 - 18" Towel Shelf - Chrome Plated Zamac	0.31	1.90	\$ 40.00	
		9301-18" Towel Shelf With Bar - Chrome Plated Zamac	0.46	2.47	\$ 69.00	
		9301-24" Towel Shelf With Bar - Chrome Plated Zamac	0.01	2.67	\$ 71.00	
	931	931 Single Robe Hook - Chrome Plated Zamac	0.01	0.19	\$ 2.00	
		9311 Towel Hook - Chrome Plated Zamac	0.02	0.30	\$ 10.00	
		9314 Towel Hook - Satin Stainless Steel	0.01	0.32	\$ 8.00	BX
		9315 Towel Hook - Bright Polish	0.03	0.26	\$ 12.00	
	932	Double Robe Hook - Chrome Plated Zamac	0.01	0.18	\$ 3.00	BX
	933	9334 Towel Ring - Satin Stainless Steel	0.03	0.47	\$ 10.00	
9335 Towel Ring - Bright Polish		0.03	0.46	\$ 13.00	BX	
	934	Towel Ring - Chrome Plated Zamac	0.04	0.28	\$ 11.00	
	935	9352 Soap Dish - Recessed, Bright Polish	0.09	0.69	\$ 20.00	
		9353 Soap Dish - Recessed, Stainless Steel	0.10	0.69	\$ 20.00	
		9362 Soap Dish With Bar - Bright Polish	0.10	1.40	\$ 21.00	

Notes

*For information on options on this page please contact your local Sales Representative or Customer Service









Washroom Accessories Division

TEL: 1-800-BRADLEY FAX: 262-251-5817

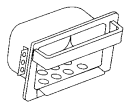
Web Site: www.bradleycorp.com

Effective Date February 1, 2017

Series 900 - Hotel, Hospital/Patient Care, Custodial Accessories

	Model No.	Description	Shipping Data		Price Each \$	
			Cu. Ft.	Wt. Lbs.		
	940	Soap Dish With Bar - Recessed, Stainless Steel, w/ Mortar Lugs	0.10	1.31	\$ 23.00	
	9401	Soap Dish - Recessed, Stainless Steel, with Mortar Lugs	0.07	0.93	\$ 21.00	
	9402	Soap Dish With Bar - Recessed, with wall clamp	0.16	1.80	\$ 32.00	
	9403	Soap Dish - Recessed, with wall clamp	0.08	2.50	\$ 23.00	BX
	947	Retractable Clothesline	0.02	0.52	\$ 13.00	
	949	Cup Dispenser - Surface-Mtd.	0.80	3.75	\$ 315.00	
	9495	Cup Dispenser - Surface-Mtd., Stainless Steel	0.39	2.74	\$ 80.00	
	9522	9522-060 Shower Rod Ceiling Support - required for rods longer than 72" Chrome Plated Brass, For 1 1/4" O.D. Rod, 6" St'd	0.01	0.24	\$ 38.00	
	9530	9530-60 Curved Shower Curtain Rod - 60" Satin Finish	0.59	2.50	\$ 69.00	BX
		9530-6078 Curved Shower Curtain Rod - 60" High Polish Finish	0.59	2.50	\$ 69.00	BX
		9530-72 Curved Shower Curtain Rod - 72" Satin Finish	0.71	3.30	\$ 82.00	
		9530-7278 Curved Shower Curtain Rod - 72" High Polish Finish	0.71	3.30	\$ 82.00	
	9536	Shower Curtain Hook, each	0.01	0.01	\$ 1.00	BX
	9540	Shower Curtain Hook with Roller, each	0.01	0.02	\$ 1.00	BX
	953	953 Shower Rod - 18 Gauge Stainless Steel, Exposed Flange				
	1" O.D.	953-036 Shower Rod - 36" Length	0.14	1.65	\$ 21.00	BX
		953-048 Shower Rod - 48" Length	0.18	2.26	\$ 28.00	
		953-060 Shower Rod - 60" Length	0.23	2.63	\$ 30.00	BX
		953-072 Shower Rod - 72" Length	0.27	3.09	\$ 41.00	
	9538	9538 Shower Rod - 18 Gauge Stainless Steel, Concealed Flange				
	1" O.D.	9538-036 Shower Rod - 36" Length	0.17	1.79	\$ 26.00	BX
		9538-048 Shower Rod - 48" Length	0.23	2.31	\$ 32.00	
		9538-060 Shower Rod - 60" Length	0.28	2.91	\$ 37.00	BX
		9538-072 Shower Rod - 72" Length	0.34	3.34	\$ 46.00	
	9531	9531 Shower Rod - 18 Gauge Stainless Steel, Exposed Flange				
	1 1/4" O.D.	9531-036 Shower Rod - 36" Length	0.17	2.01	\$ 22.00	BX
		9531-042 Shower Rod - 42" Length	0.20	2.44	\$ 24.00	BX
		9531-048 Shower Rod - 48" Length	0.23	2.66	\$ 25.00	BX
		9531-060 Shower Rod - 60" Length	0.28	3.36	\$ 31.00	BX
		9531-072 Shower Rod - 72" Length	0.27	3.77	\$ 38.00	
	9539	9539 Shower Rod - 18 Gauge Stainless Steel, Concealed Flange				
	1 1/4" O.D.	9539-036 Shower Rod - 36" Length	0.17	2.18	\$ 38.00	BX
		9539-048 Shower Rod - 48" Length	0.23	2.95	\$ 43.00	
		9539-060 Shower Rod - 60" Length	0.28	3.46	\$ 44.00	BX
		9539-072 Shower Rod - 72" Length	0.34	4.08	\$ 53.00	
OPTIONS	-4	Bright Polish Finish				*
Models 953, 9531, 9538, 9539						

Notes *For information on options on this page please contact your local Sales Representative or Customer Service

Prices subject to change without notice.
Items may be changed or discontinued without notice and without incurring obligation.



Washroom Accessories Division

TEL: 1-800-BRADLEY FAX: 262-251-5817

Web Site: www.bradleycorp.com

Effective Date February 1, 2017

Series 900 - Hotel, Hospital/Patient Care, Custodial Accessories

Model No.	Description	Shipping Data		Price Each \$	
		Cu. Ft.	Wt. Lbs.		
9533	9533 Shower Curtain - 6 Ga. Vinyl, White				
	9533-3672 Shower Curtain - 6 Ga. Vinyl, White - 36"x72"	0.03	0.75	\$ 13.00	BX
	9533-4272 Shower Curtain - 6 Ga. Vinyl, White - 42"x72"	0.03	0.77	\$ 14.00	BX
	9533-4872 Shower Curtain - 6 Ga. Vinyl, White - 48"x72"	0.04	1.50	\$ 14.00	
	9533-6072 Shower Curtain - 6 Ga. Vinyl White - 60"x72"	0.04	1.50	\$ 15.00	
9533-7272 Shower Curtain - 6 Ga. Vinyl, White - 72"x72"	0.04	1.28	\$ 16.00	BX	
9534	9534 Shower Curtain - 8 oz. Duck, White				
	9534-3672 Shower Curtain - 8 oz. Duck, White - 36"x72"	0.07	0.50	\$ 25.00	
	9534-4272 Shower Curtain - 8 oz. Duck, White - 42"x72"	0.06	3.00	\$ 32.00	
	9534-4872 Shower Curtain - 8 oz. Duck, White - 48"x72"	0.60	1.23	\$ 32.00	
	9534-6072 Shower Curtain - 8 oz. Duck White - 60"x72"	0.09	1.40	\$ 34.00	
9534-7272 Shower Curtain - 8 oz. Duck, White - 72"x72"	0.09	1.50	\$ 36.00		
9535	9535 Shower Curtain - 10 oz. Nylon/Vinyl, Green				
	9535-3672 Shower Curtain - 10 oz. Nylon/Vinyl, - 36"x72"	0.08	2.00	\$ 29.00	
	9535-4272 Shower Curtain - 10 oz. Nylon/Vinyl, - 42"x72"	0.06	1.62	\$ 35.00	
	9535-4872 Shower Curtain - 10 oz. Nylon/Vinyl, - 48"x72"	0.06	2.25	\$ 36.00	
	9535-6072 Shower Curtain - 10 oz. Nylon/Vinyl, - 60"x72"	0.08	2.45	\$ 45.00	
9535-7272 Shower Curtain - 10 oz. Nylon/Vinyl, - 72"x72"	0.08	2.51	\$ 49.00		
9537	9537 Shower Curtain - 10 oz. Nylon/Vinyl, White				
	9537-3672 Shower Curtain - 10 oz. Nylon/Vinyl, - 36"x72"	0.08	1.36	\$ 29.00	
	9537-4272 Shower Curtain - 10 oz. Nylon/Vinyl, - 42"x72"	0.07	2.00	\$ 33.00	BX
	9537-4872 Shower Curtain - 10 oz. Nylon/Vinyl, - 48"x72"	0.06	3.50	\$ 35.00	BX
	9537-6072 Shower Curtain - 10 oz. Nylon/Vinyl, - 60"x72"	0.07	3.25	\$ 39.00	
9537-7272 Shower Curtain - 10 oz. Nylon/Vinyl, - 72"x72"	0.08	3.00	\$ 43.00	BX	
954	954 Shower Seat Hinged Corner - Stainless Steel	0.10	5.47	\$ 215.00	
	9541 Shower Seat Fixed Corner - Stainless Steel	0.16	4.52	\$ 142.00	
956	9562 Folding Shower Seat - White, Phenolic, Barrier Free	0.47	22.40	\$ 478.00	BX
	9569 Reversible Shower Seat - White, Phenolic, Barrier Free	0.47	22.40	\$ 341.00	BX
957	957 Bariatric Shower Seat - Phenolic, White, Left Hand	3.13	28.00	\$ 809.00	
	9571 Bariatric Shower Seat - Phenolic, White, Right Hand	3.13	28.00	\$ 809.00	
958	958 Bariatric Shower Seat - Phenolic, White, Bench	3.13	27.00	\$ 826.00	
959	9591 Folding Shower Seat - White, Phenolic	1.25	12.90	\$ 374.00	BX
	9592 Folding Shower Seat - White, Bradmar	1.25	14.65	\$ 394.00	BX
	9593 Folding Shower Seat - White, Bradmar, Barrier Free	2.88	22.76	\$ 442.00	BX
	9594 Reversible Shower Seat - White, Bradmar, Barrier Free	2.88	29.07	\$ 559.00	BX
961	961 Baby Changing Station - Surf-Mtd, Grey Granite, Oval	2.63	22.00	\$ 285.00	BX
	9611 Baby Changing Station - Surf-Mtd, Solid Light Grey, Oval	2.63	22.00	\$ 285.00	BX
	9612 Baby Changing Station - Surf-Mtd, Solid Ivory, Oval	2.63	22.00	\$ 285.00	BX
962	962 Stainless Steel Baby Changing Station - Recessed	3.28	55.00	\$ 1,553.00	BX
	962-11 Stainless Steel Baby Changing Station - Surface-Mtd.	3.28	65.00	\$ 1,886.00	BX
963	9631 Baby Changing Station - Surf-Mtd, Light Grey, Rectangular	1.68	17.40	\$ 285.00	BX
	9632 Baby Changing Station - Surf-Mtd, Cream, Rectangular	1.68	17.40	\$ 285.00	BX
966	9661 Medicine Cabinet - Recessed, 16" x 22", Polystyrene	1.78	9.00	\$ 88.00	BX
	9663 Medicine Cabinet - Recessed, 16" x 26"	2.69	16.20	\$ 78.00	BX
	9664 Medicine Cabinet - Surface-Mtd., 16" x 22"	1.05	13.50	\$ 119.00	BX

*For information on options on this page please contact your local Sales Representative or Customer Service

Prices subject to change without notice.
Items may be changed or discontinued without notice
and without incurring obligation.









Washroom Accessories Division

TEL: 1-800-BRADLEY FAX: 262-251-5817

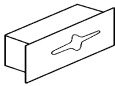
Web Site: www.bradleycorp.com

Effective Date February 1, 2017

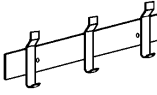
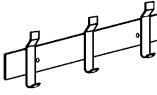
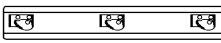
Series 900 - Hotel, Hospital/Patient Care, Custodial Accessories

	Model No.	Description	Shipping Data		Price Each \$	
			Cu. Ft.	Wt. Lbs.		
	9813	Specimen Pass-Thru Cabinet	1.56	11.42	\$ 266.00	BX
	987	Facial Tissue Dispenser - Recessed, Satin Finish	0.11	1.72	\$ 26.00	
	987-78	Facial Tissue Dispenser - Recessed, Polished	0.11	2.00	\$ 26.00	
	987-11	Facial Tissue Dispenser - Surface-Mtd.	0.28	2.09	\$ 46.00	
	987-36	Facial Tissue Dispenser - Recessed, Large Capacity	0.18	2.12	\$ 26.00	BX
	989	Needle Disposal - Recessed, Satin Finish	1.18	11.50	\$ 290.00	BX
	989-11	Needle Disposal - Surface-Mtd. Satin Finish	1.18	13.20	\$ 365.00	
	990	LeakProof Bed Pan Storage Cabinet - Recessed	3.24	21.50	\$ 608.00	
	9905	Bed Pan/Urinal Holder - Surface-Mtd.	2.63	10.00	\$ 99.00	
	991	Corner Guard - 40"	0.46	5.07	\$ 57.00	
	991-48	Corner Guard - 48"	0.64	6.00	\$ 69.00	
	991-60	Corner Guard - 60"	0.80	8.00	\$ 84.00	
	991-72	Corner Guard - 72"	1.00	10.00	\$ 102.00	
	991-96	Corner Guard - 96"		13.00	\$ 139.00	
	993	Utility Shelf - Surface-Mtd., 34"	4.49	19.14	\$ 202.00	BX
	9934	Utility Shelf - Surface-Mtd., 44"	4.49	24.80	\$ 338.00	
	994	Hat and Coat Rack - Surface-Mtd., 24"	0.58	3.00	\$ 51.00	BX
	9944	Hat and Coat Rack - Surface-Mtd., 36"	1.00	3.81	\$ 62.00	
	9945	Hat and Coat Rack - Surface-Mtd., 48"	1.00	4.36	\$ 78.00	
	9946	Hat and Coat Rack - Surface-Mtd., 60"	1.48	5.64	\$ 95.00	
	995	Mop and Broom Holder - Surface-Mtd., 24"	0.43	2.50	\$ 43.00	BX
	9954	Mop and Broom Holder - Surface-Mtd., 36"	0.43	4.00	\$ 58.00	BX
	9955	Mop and Broom Holder - Surface-Mtd., 48"	0.46	4.91	\$ 81.00	
	998	Utility Shelf - Surface-Mtd., 30"	1.93	9.38	\$ 114.00	
	9984	Utility Shelf - Surface-Mtd., 36"	2.20	10.00	\$ 150.00	BX
	9985	Utility Shelf - Surface-Mtd., 42"	1.93	14.62	\$ 169.00	
	9986	Utility Shelf - Surface-Mtd., 48"	1.93	16.43	\$ 178.00	

Notes *For information on options on this page please contact your local Sales Representative or Customer Service





Washroom Accessories Division

TEL: 1-800-BRADLEY FAX: 262-251-5817

Web Site: www.bradleycorp.com

Prison/Detention Center Accessories

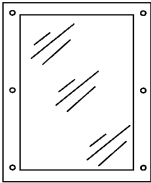
Effective Date February 1, 2017

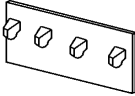
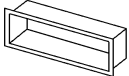
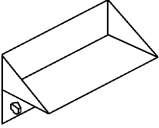
	Model No.	Description	Shipping Data		Price Each \$	
			Cu. Ft.	Wt. Lbs.		
SECURITY MIRRORS 	SA01-1	12" x 16", Type 304 #8 Stainless Steel Mirror, Chase Mtd.*	0.52	10.00	\$ 176.00	
	SA01-2	12" x 16", Type 430, Brite Annealed Mirror, Chase Mtd.*	0.14	7.53	\$ 143.00	
	SA01-4	12" x 16", Tempered Glass Mirror, Chase Mtd.*	0.30	10.00	\$ 171.00	
	SA01-5	12" x 16", Plexiglass Mirror, Chase Mtd.*	0.78	18.00	\$ 181.00	
	SA03-1	12" x 16", Type 304 #8 Stainless Steel Mirror, Front Mtd.	0.52	6.73	\$ 174.00	
	SA03-2	12" x 16", Type 430, Brite Annealed Mirror, Front Mtd.	0.52	6.72	\$ 143.00	
	SA03-4	12" x 16", Tempered Glass Mirror, Front Mtd.	0.60	10.00	\$ 126.00	
	SA03-5	12" x 16", Plexiglass Mirror, Front Mtd.	0.59	18.00	\$ 130.00	
INTEGRAL MIRRORS	SA05	Integral Framed Stainless Steel Mirror, 11-1/4" x 17-1/4"	0.56	5.00	\$ 72.00	
	SA06	Integral Framed Stainless Steel Mirror, 10 1/16" x 11 9/16"	0.08	8.00	\$ 102.00	
TOILET TISSUE HOLDER 	SA09-6	Chase Mtd.*	0.06	3.00	\$ 95.00	
	SA10	Front Mtd.	0.40	2.00	\$ 53.00	
	SA11-6	Chase Mtd.*	0.22	5.00	\$ 102.00	
	SA12	Front Mtd.	0.12	3.00	\$ 141.00	
	SA13-6	Chase Mtd.*	0.06	4.00	\$ 161.00	
	SA14	Front Mtd.	0.21	4.00	\$ 130.00	
	SA15	Partition Mtd.	0.21	4.00	\$ 195.00	
SOAP DISH 	SA16	Chase Mtd.*	0.16	2.00	\$ 59.00	
	SA21	Chase Mtd.*	0.03	1.00	\$ 111.00	
	SA22	Front Mtd.	0.03	1.00	\$ 60.00	
TOOTHBRUSH HOLDER	SA25	Chase Mtd.*	0.02	1.00	\$ 91.00	
	SA26	Front Mtd.	0.03	1.00	\$ 88.00	
SAFETY TOWEL HOOK	SA30	Chase Mtd.*	0.03	1.23	\$ 147.00	
	SA31	Front Mtd.	0.04	0.91	\$ 67.00	
	SA35	Chase Mtd.*	0.02	1.00	\$ 112.00	
	SA36	Front Mtd.	0.04	0.87	\$ 79.00	
SAFETY CLOTHES HOOK STRIP 	SA32	Chase Mtd.*	0.19	6.00	\$ 254.00	
	SA33	Front Mtd.	0.50	4.50	\$ 238.00	
	SA37	Front Mtd.	0.01	0.41	\$ 24.00	
	SA38	Chase Mtd.*	0.38	5.00	\$ 229.00	
	SA39	Front Mtd.	0.50	4.43	\$ 149.00	
	SA41	Front Mtd.	0.52	7.00	\$ 276.00	
	SHELF 	SA47	Chase Mtd.*	0.31	6.00	\$ 247.00
		SA49	Chase Mtd.*	0.12	8.00	\$ 167.00
SA50		With Toothbrush Holders.*	0.13	8.00	\$ 188.00	
BOOKSHELF 	SA51	With Clothes Hooks - Stainless Steel, Chase Mtd.*	1.56	11.00	\$ 472.00	
	SA52	With Clothes Hooks - Stainless Steel, Front Mtd.	1.56	15.00	\$ 447.00	
	SA53	With Clothes Hooks - Chase Mtd.*	1.25	16.00	\$ 472.00	
	SA54	With Clothes Hooks - Front Mtd.	1.56	16.00	\$ 447.00	
	SA55	Chase Mtd.*	0.63	8.00	\$ 231.00	
	SA56	Front Mtd.	0.63	8.00	\$ 226.00	
SECURITY GRAB BAR	SA70-00118	Security Grab Bar, Front Mtd.	0.13	3.50	\$ 99.00	
	SA70-00124	Security Grab Bar, Front Mtd.	0.17	3.67	\$ 106.00	
	SA70-00136	Security Grab Bar, Front Mtd.	0.24	5.26	\$ 109.00	
	SA70-00142	Security Grab Bar, Front Mtd.	0.28	6.01	\$ 124.00	
	SA70-00260	Security Grab Bar, Front Mtd.	0.39	8.75	\$ 278.00	

NOTES

**All Chase Mtd. items are priced for a 6" wall.*

Prices subject to change without notice.
 Items may be changed or discontinued without notice
 and without incurring obligation.