

STANLEY

2008-2009

Industrial Tools & Fasteners

[®]
BOSTITCH

Efficient Solutions For Specific Industrial Applications.

Pallets

Crating

Fencing

Upholstered Furniture

Case Goods

Manufactured Housing

Bedding

Millwork

Specialty





WHY BOSTITCH?

We torture our tools to make them better. We drop them, drag them, pummel them, shake them, and even freeze them under sub-zero conditions. Why go to these extremes? Because we know that you demand superior performance. BOSTITCH is up to your challenge; you can depend on us ... no excuses.



IMPORTANT SAFETY INFORMATION



IMPORTANT – READ CAREFULLY

You, and others working around you, can be seriously injured by fastener driving tools if you do not follow the instructions provided on the tool and in the operator's manual. Used properly, these tools provide easy, safe, and efficient methods for driving nails and staples for all kinds of construction projects.

REFER to your Operator's Manual, Parts List, or call Bostitch® Customer Service at: 1-800-556-6696 if any of the terms used below are unfamiliar to you.



EYE PROTECTION which conforms to ANSI Z87.1 specifications and provides protection against flying particles both from the **FRONT** and **SIDE** should **ALWAYS** be worn by the operator and others in the work area when connecting to air supply, loading, operating or servicing this tool. Eye protection is required to guard against flying fasteners and debris, which could cause severe eye injury.

THE CONTACT OR SEQUENTIAL TRIP

Bostitch offers two types of triggers for pneumatic tools: Contact Trip (black trigger) and Sequential Trip (silver-gray trigger). Each trigger has specific advantages. For example, the Contact Trip is best suited for high-volume, rapid nailing or stapling where exact placement of the fastener is not important.

The Sequential Trip is best suited for applications where rapid nailing is not required or where the exact placement of the fasteners is important. You should evaluate your construction project to determine which trigger type is best for you.

CONTACT TRIP

A Bostitch® tool with the Contact Trip (black trigger) will drive a nail whenever both the trip and the trigger are depressed at the same time.

The tool can be used to rapidly drive nails by holding the trigger pulled and repeatedly bumping the trip against the work to be nailed (Bump Firing). A nail is driven each time the trip is bumped against the work.

The Contact Trip (black trigger) will not prevent a nail from being accidentally driven if the trigger is held, pulled and the trip is bumped against any object or person. Never hold or carry the tool with your finger on the trigger unless driving fasteners.

The Contact Trip (black trigger) can also be operated by holding the tool against the work with the trip depressed and then pulling the trigger (Place Nailing).

When using a Contact Trip for Place Nailing, the tool may bounce due to recoil, and if the tool is allowed to recontact the work surface while you are holding the trigger, a second nail will be driven. The operator should allow the tool to recoil far enough to release the trip and avoid a second cycle. Don't push the tool down extra hard; let the tool do the work.

SEQUENTIAL TRIP

The Sequential Trip (silver-gray trigger) offers a positive safety advantage since it will not accidentally drive a nail if the tool is bumped against any surface or while the operator is holding the tool with the trigger pulled.

It also allows Place Nailing without the possibility of driving a second nail on recoil as described under "Contact Trip."

The Sequential Trip (silver-gray trigger) gets its name from the "sequence" required to operate the tool. To drive a nail, the operator must first depress the trip against the work and then pull the trigger. To drive a second nail, the operator must lift the tool from the work, release the trigger, and then repeat the above sequence.

If further information is required, call Bostitch® Customer Service at 1-800-556-6696 or write to: Bostitch® Customer Service, 1 Briggs Drive, East Greenwich, RI 02818.

TABLE OF CONTENTS

This catalog was designed to highlight the complete Industrial line of Bostitch® tools and collated fasteners specifically suited for a particular industry.

INDUSTRIAL APPLICATIONS

PALLETS, CRATING, FENCING	8 - 11
UPHOLSTERED FURNITURE	12 - 16
CASE GOODS	17 - 19
MANUFACTURED HOUSING	20 - 25
BEDDING	26 - 29
MILLWORK	30 - 33
CARTON AND BAG CLOSURE	34 - 39
SPECIALTY APPLICATIONS	40 - 44

PART NUMBER SELECTION GUIDE

HARTCO™ CLIPS	45, 52, 53
NAILS	46 - 49
STAPLES	50 - 51
SPENAX™ RINGS	54 - 55
ACCESSORIES	56 - 57
APPLICATIONS INDEX & WIRE	58
TOOL INDEX	59
TOOLS & ACCESSORIES PART NUMBER GUIDE	60 - 62
NOTES PAGE	63



WHO IS

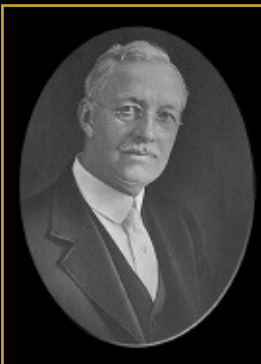

We work hard to maintain our position as the market leader. That's a tradition that Thomas Briggs, our founder, started when he invented the world's first stapler back in 1896. Over 110 years later, the spirit of quality & innovation lives on in everything we do - from field research to new product development. Whether it's the introduction of the world's first collated staple or the new Strapshot™ metal connector nailer, one thing remains true ...

BOSTITCH is indeed the authentic fastener brand.





BOSTITCH?

We strive to meet a higher standard. For example, our award-winning HurriQuake™ nail  is proven to be up to 2x's more resistant to hurricane winds. According to Popular Science magazine, this unique breakthrough can save millions of dollars and thousands of lives. Our passion for excellence makes us better ... each one of our 1,300 employees are determined to make a difference and improve the way work is to be done.

We are BOSTITCH. And Proud of it.



STANLEY

BOSTITCH®

STANLEY
BOSTITCH

PALLETS, CRATING, FENCING

Why Does It Pay to Have a Fat Head?

264% More Protection from End Board Impact

40% Greater Shear Resistance

35% Increase in Withdrawal Performance

17% Increase in Diagonal Rigidity

15% Greater Resistance to Pull-Through

Patented Fat Head

19% larger than standard nails, providing maximum shear and pull-through resistance



Advanced "No Void" Shank Technology

Deep screw shank results in maximum withdrawal performance

Precision Point

Reduces splitting in hardwoods

STANLEY

BOSTITCH

Pallet Plus™

Revolutionary Nail Technology

Now that's innovation from **BOSTITCH**®

5 Great Product Lines Featuring Fat Head™ Technology

Pallet Plus™ .084" Collated Nails

Your replacement for standard .099" pallet nails. Our patented nail geometry delivers equivalent performance to standard .099" pallet nails using a shorter and thinner nail. Also take advantage of the 20% lighter N64084 tool.

- Equal Performance vs. Standard .099" Collated Pallet Nails
- Use a Lighter Tool
- Increase Productivity
- Reduce Operator Fatigue

Pallet Plus™ .099" Collated Nails

Best-in-class performing .099" pallet nails. Our patented geometry delivers equivalent performance to standard .113" pallet nails. Your replacement for .105" or .113" collated nails used for new pallet construction or repair.

- Equal Performance vs. Standard .113" Collated Pallet Nails
- More Trips Until Repair vs. Standard .099" Nails
- More Durable Pallet
- Increase Customer Satisfaction

Pallet Plus™ .105" BULK Nails

Your replacement for standard .113" bulk nails. Our patented nail geometry delivers equivalent performance to standard .113" bulk nails. You can build up to 27 more pallets per box which equates to over 19,000 more pallets per truckload of nails.

- Equal Performance vs. Standard .113" Bulk Nails
- Value-Added Performance
- Build 20% More Pallets per Box

Block Mat Nails: .099" Wedge Grip™ Pallet Plus

Your replacement for standard .135" block mat nails. Utilizing both patent pending Wedge Grip™ and patented Fat Head™ technologies, this nail delivers ultimate deck mat performance using four nails per joint.

- One More Pallet Trip Until Repair
- 37% Greater Withdrawal Resistance per Joint
- Reduce Wood Splitting

Fencer Plus™ .084" Wedge Grip™ Collated Nails

Your replacement for standard .090" fencing nails. Utilizing both patent pending Wedge Grip™ and patented Fat Head™ technologies, this nail delivers ultimate performance in wood fences. ThickCoat™ galvanized for protection against the most corrosive pressure treated lumbers.

- Equal Performance vs. Standard .090" Fencing Nails
- Reduce Wood Splitting
- ThickCoat™ Galvanization (approved for ACQ lumber)

We pack about **1,500 more nails** into our boxes than the competition.

More nails = more pallets.



Bostitch offers an extensive line of hard-working, long-lasting industrial strength pneumatic tools.

Pallet Repair and Assembly:

- N58C-1
- N64084-1
- N64099-1
- N89C-1P
- N70CB
- N80CB
- N400C-1
- 750S4
- 750S5
- 850S4
- CF15-2

Machine mount version and remote trigger valves are available. Consult your representative or factory.



750S4 Reattaching Deck Board



CF15-2 Pneumatic corrugated tool repairing split stringer (see also 538S214 14-gauge stapler, p. 23)

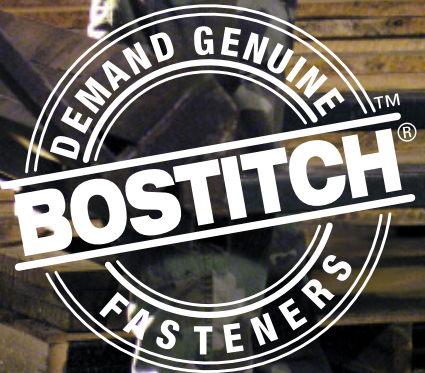
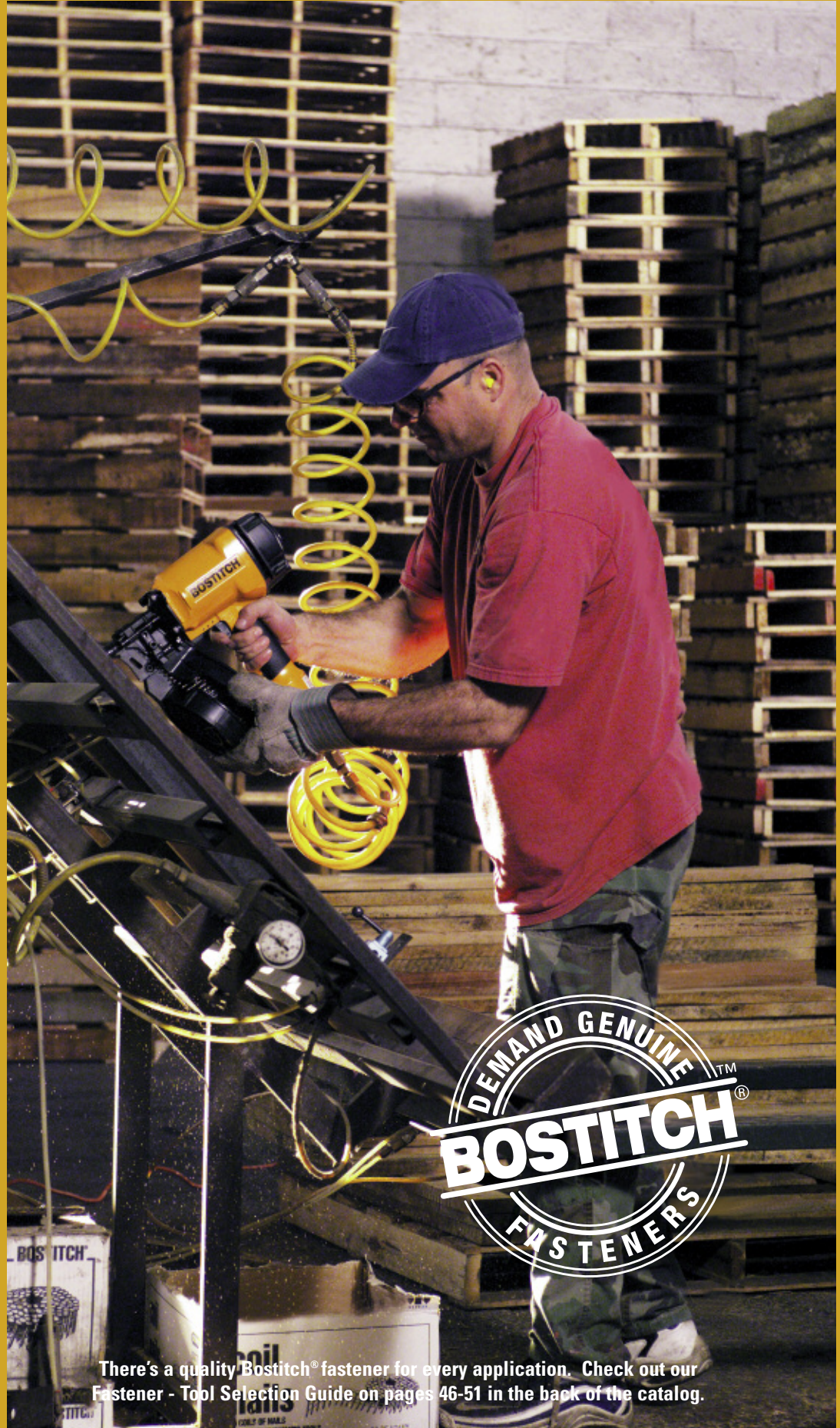

There's a quality Bostitch® fastener for every application. Check out our Fastener - Tool Selection Guide on pages 46-51 in the back of the catalog.



750S4 Assembling crate face-frame



N58C Coil nailer fastening fence header board



N400C-1 Nailing mat to block pallet

Crate Assembly:

- N58C-1
- N89C-1P
- N64
- SX150
- 538S4
- 538S5
- 750S4
- 750S5
- 850S4

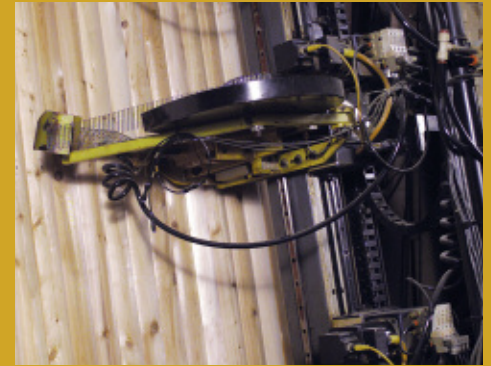

Machine mounted nailer applying Fencer Plus™ Nails

Fence Assembly:

- N58C-1
- N64
- N80CB
- HFP9

(see also page 42 of specialty fencing selection)



HFP9 Attaching tensioning wire to chainlink fence with 9 gauge aluminum hog rings





N58C-1

Box Frame Nailer

Features:

- Uses wire collated nails
- Durable cast aluminum frame and cap
- Oversized canister opens completely for fast

Applications:

- Pallets assembly and repair
- Fence panel assembly
- Crate assembly

Tool Description:

- Tool Weight: 5.7 lbs.
- Driving Power: 445 inch lbs. @ 100 psi
- Magazine Capacity: 300 to 350 depending on nail size
- 1" to 2-1/4" inch (2d to 7d)

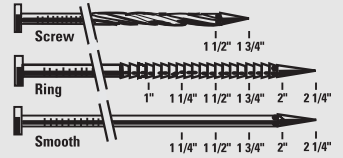

Available in: Plain, galvanized, stainless steel, aluminum

REFER TO AC, C AND FC SERIES
ON PAGES 46- 48



N64084-1, N64099-1 (restricted tool)

Pallet, Crate, Fence Nailer

Features:

- Uses wire collated nails
- .084" model has oversized bore for driving .084" Pallet Plus nails
- .099" model has oversized bore for driving .099" Pallet Plus and WB nails
- Oversized canister opens completely for easy reloading
- Tool-free adjustable exhaust

Applications:

- Crate frames, medium duty pallet assembly and repair
- Fence panel assembly
- Picket assembly using aluminum nails

Tool Description:

- Tool Weight: 6.1 lbs.
- Driving Power: 560 inch lbs. @ 100 psi
- Magazine Capacity: 225 to 350 depending on nail size
- 1-1/4" to 2-1/2" (3d to 8d)

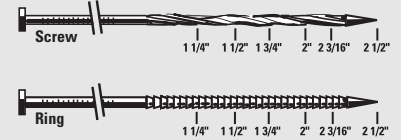

Available in: Plain, galvanized, stainless steel, aluminum**
**Aluminum nails require door conversion kit (Item#112670)

REFER TO AC, C, ACP AND FC SERIES
ON PAGES 46-48



N70CB (restricted tool)

Heavy Duty Pallet Nailer

Features:

- Uses wire collated nails
- Angled coil design for high operator visibility
- Quick loading canister
- Better balance for operating ease

Applications:

- Heavy duty pallet assembly

Tool Description:

- Tool Weight: 7.9 lbs.
- Driving Power: 738 inch lbs. @ 100 psi
- Magazine Capacity: 225 to 300 depending on nail size
- 1-1/2" to 2-3/4" (4d to 9d)

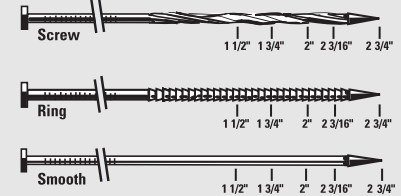

Available in: Plain, galvanized, stainless steel, aluminum**
**Aluminum nails require door conversion kit (Item#112670)

REFER TO AC, C, FC, FC PALLET PLUS SERIES
ON PAGES 46-48



N80CB, N89C-1P

Heavy Duty Pallet, Fence Nailer

Features:

- Quick open canister
- Rubber comfort grip
- Drives wire collated nails .099"-.148"

Applications:

- Heavy duty block pallet assembly
- Heavy duty picket fence assembly

Tool Description:

- Tool Weight: 8.4 lbs. / 8.1 lbs.
- Driving Power: 880 inch lbs. / 1050 inch lbs.
- Magazine Capacity: 225 to 300 depending on nail size

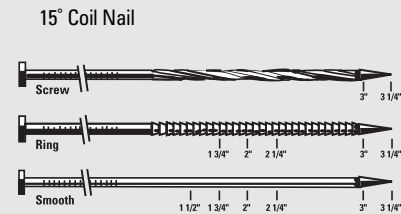

Available in: Plain, galvanized, stainless steel

REFER TO AC, C, FC, FC PALLET PLUS SERIES
ON PAGES 46-48



N400C-1 (restricted tool)

Hardwood Pallet, Crate Nailer

Features:

- Drives wire collated nails from .099" to .148" in diameter
- Secondary handle, rubber grip and integral balancer mounting point in cap

Applications:

- Block pallet assembly
- Hardwood Crate and Pallet Assembly

Tool Description:

- Tool Weight: 11.6 lbs.
- Driving Power: 1450 inch lbs. @ 100 psi
- Magazine Capacity: 225 to 300 depending on nail size

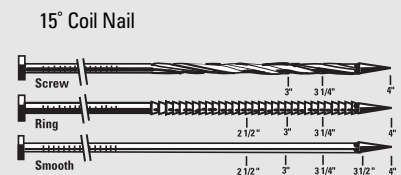

Available in: Plain, galvanized, stainless steel

REFER TO AC, C AND FC SERIES
ON PAGES 46-48

538S4, 538S5

Medium Duty Crate Stapler

Features:

- Anti-Jam™ magazine permits staples to exit nose without jamming
- Long narrow nose for improved line of sight
- Adjustable trip for positive staple depth control
- Long magazine kit available: 108xxx, p.60

Applications:

- Light and medium duty crate framing and sheathing

Tool Description:

- Tool Weight: 4.7 lbs.
- Driving Power: 260 inch lbs. @ 100 psi
- Magazine Capacity: 160
- Long Magazine: 300 +
- S4: 3/8" to 1-1/2" inch leg
- S5: 1/2" to 2" inch leg

16-Gauge S4 Staple

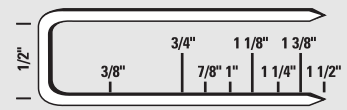

16-Gauge S5 Staple

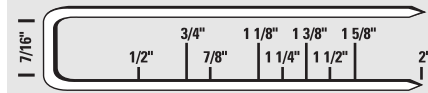

REFER TO 16S4, S5 STAPLES ON PAGE 50



750

750S4, 750S5, 850S4

Heavy Duty Pallet, Crate Stapler

Features:

- Anti-Jam™ breathing magazine permits staples to exit nose without jamming
- Long magazine kit available: 108xxx, p.60

Tool Description:

- 750S4-S5**
- Tool Weight: 5.3 lbs.
 - Driving Pwr: 465 inch lbs. @ 100 psi
 - Magazine Capacity: 160
 - Long Magazine: 300 +
 - S4 and S5: 1-1/2" to 2" inch leg

850S4

- Tool Weight: 5.9 lbs.
- Driving power: 570 inch lbs.
- Magazine Capacity: 160
- Long Magazine: 300 +
- 1-1/2" to 2" inch leg

Applications:

- Heavy duty pallet manufacturing and repair
- Heavy duty crate framing

16-Gauge S4 Staple

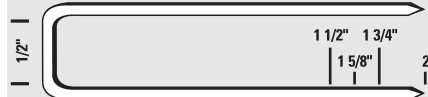

16-Gauge S5 Staple

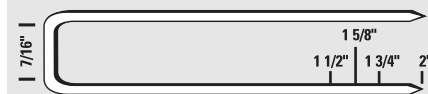

REFER TO 16S4, S5 STAPLES ON PAGE 50



850

HFP9

Wire Fence Tool

Features:

- Allows collated hog rings to feed directly into the jaws
- Magazine pivots, allowing the tool to reach into difficult areas to fasten tension wire

Applications:

- Fastening tensioning wire, signs to fence, stitching butt ends, and repair

Tool Description:

- Tool Weight: 1.2 lbs.
- Magazine Capacity: 25 rings

RING09AL25

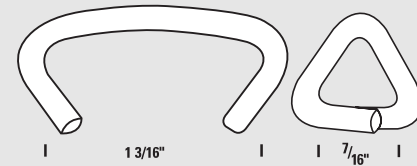

Available in: Aluminum

REFER TO #8 ON PAGES 54 & 55



CF15-2

Pallet Stringer Repair

Features:

- Powerful to provide full penetration of stringers

Applications:

- Repairing and strengthening split pallet stringers

Tool Description:

- Tool Weight: 6.58 lbs.
- Driving Power: 433 inch lbs.
- Magazine Capacity: 108

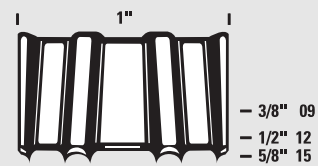

Corrugated

REFER TO PAGE 49



Also for stringer repair see 14-gauge Wide Crown Stapler 538S214 page 21

To increase productivity, it takes a quality craftsman and the right tool for the right job. Bostitch is your partner every step of the way.

Furniture Frame Assembly:

- 538S4
- 538S5
- 650S4
- 650S5

Spring Assembly:

- 438S5
- AK Automatic
- AK Semi Automatic
- TRK Automatic
- TRK Semi Automatic
- HR-65C-130
- HR-66C-110

Trim Assembly:

- SX150
- BT125
- BT200
- S32SX
- BT35B
- BT50B
- N62FN
- N52FN

Fabric to Wood:

- 21671B
- 21671B-A
- 21671B-ALM
- 21671B-LN
- 21680B
- 21680B-LN
- 21697B
- LockNail™ System

Packaging:

- 450S2

Fabric to Wire:

- TR201
- TR203
- TR315

538S4 Stapler applying staples during knock-up



Sinuous spring anchor clip application to chair rail w/ AK Machine



438S5 Stapler applying anchor clip to chair rail



There's a quality Bostitch® fastener for every application. Check out our Fastener - Tool Selection Guide on pages 46-51 in the back of the catalog.





HR-66C-110 Clip Tool connecting tie wire to sinuous springs

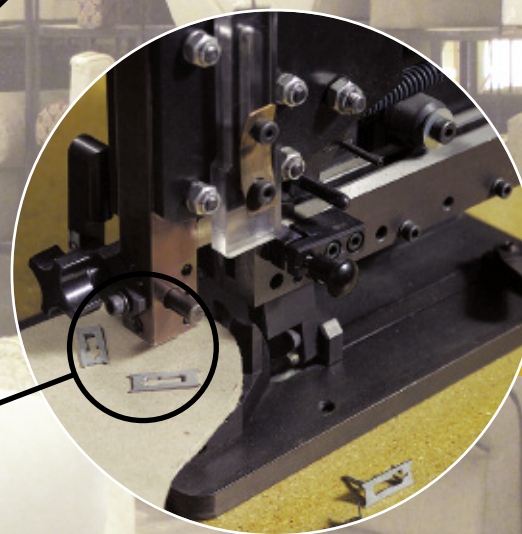

LockNail™ Machine applying LockNail™ to upholstered panel



21671B Upholstery Tacker fastening fabric to seat cover with 71 series fine wire staples

AK/TR Semi Automatic, AK/TRK Automatic

Spring Clip to Rail Application

Features:

- AK Semi Automatic: HR-55740**
- TRK Semi Automatic: HR-57129**
- Allows precision placement of spring anchor clips to chair rail (straight or curved) for uniform spring alignment and ride
- Coil-fed anchor clip system
- Operator-fed single piece operation

Applications:

- Chair/loveseat/sofa frame rail spring clip application
- For best results, it is recommended that all clips be hammer closed after spring up

AK Automatic: 169601

TRK Automatic: HR-57130

- Machine includes: clipping head, ejector block, control box, translator, drive system, air system, pusher arm, sensor assembly
- End exit hold down, exit cover are available

Features:

- Electric multi-rail autofeed mechanism
- Low skill level 8000 clip/hr operation
- Store and Transfer Rail set-up offline via ethernet

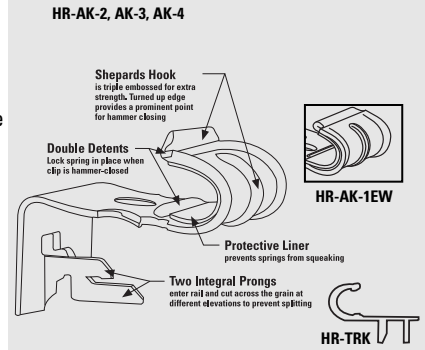

REFER TO SPRING ANCHOR CLIPS PAGE 52



438S5 Clip Kit

Spring Anchor Clip Stapler

Features:

- Ability to load OSK clip into tool prior to stapling
- Magnetic nose holds OSK clip in place for precise alignment of staple legs over clip holes
- Attachment of other sinuous spring clips to frame seat and back rails

OSK Clip

- Polypropylene lined
- Edge embossed

438S5, 538S4, 538S5

FRAME ASSEMBLY

Features:

- Anti-Jam™ magazine feeds staples without jamming
- Long narrow nose for increased visibility
- Adjustable trip for positive staple depth control
- Long magazine kit available: 108xxx, p.60

Applications:

- Low volume over-the-rail spring clip placement or applications using plywood back posts

Tool Description:

- Tool Weight: 4.7 lbs.
- Magazine Capacity: 168 Staples
- Staple: 16 S5 Series, 1/2" to 1-1/2 inch leg

Also Available:

- 438S5CLPSKIT- For front magnet and steel stop for clip alignment.
- 438S5CLPTBKIT- For front and back magnets for top and bottom clip alignment.
- 438550SKCLPKIT- For long nose clips.

See page 156

HR-OSK

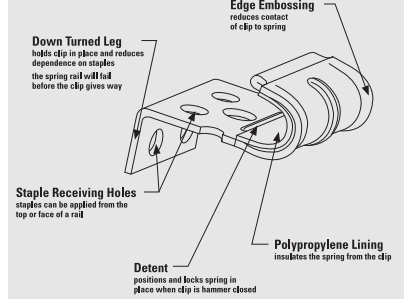

REFER TO 16 S5 SERIES ON PAGE 50
SPRING ANCHOR CLIPS (OSK) ON PAGE 52



HR-65C-130, HR-66C-110

Spring Clipping Tools

Features:

- Surface clinching tool squeezes instead of folding the clip around wires
- Driver blade cleanly picks up a clip from the magazine, places it around the wires, and forms the clip into a tight, strong wire bond

Applications:

- HR-65C-130:** Clipping smaller gauge sinuous spring to tie wire

Applications:

- HR-66C-110:** Clipping larger gauge sinuous seat and back springs to stabilizing tie wire
- Clipping coil seat springs to border wires in 8-way hand tie upholstered unit application

Tool Description:

- Clinching Power: 2000 lbs.
- Magazine Capacity: 25 to 45 collatedclips
- Regular and noise reducing (paper lined) Cushion Clips

16-Gauge S4 Staple

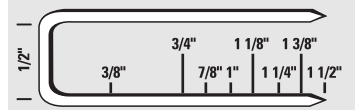

16/17-Gauge S5 Staple

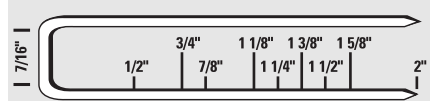

REFER TO 16 S4, S5 SERIES ON PAGE 50

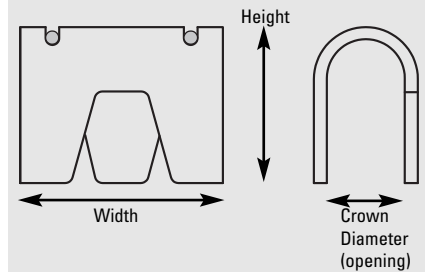

For Spring to Tie Wire sizing, refer to the Sinuous Spring application chart on Pg 43

REFER TO REGULAR AND CUSHION CLIP SECTION ON PAGE 53

650S4, 650S5

Furniture Frame Construction

Features:

- Anti-Jam™
- Increased power to countersink staples into hardwood
- Overmolded rubber comfort grip
- Long narrow nose for improved line of sight in precise applications

Applications:

- Furniture frame knock up

Tool Description:

- Tool Weight: 4.5 lbs.
- Driving Power: 340 inch lbs. @ 100 psi
- 650S4 Magazine Capacity: 160
- 650S5 Magazine Capacity: 171
- 1 to 2 inch leg

16-Gauge S4 Staple

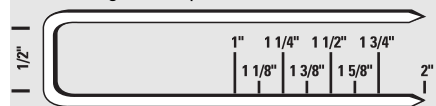

16/17-Gauge S5 Staple

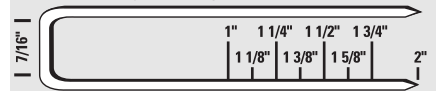

Available in: Coated

REFER TO 16 S4, S5 SERIES ON PAGE 50



LockNail™ System, HR-LN

Securing Upholstered Panels to the Frame

Features:

- The LockNail™ system is an upholstery panel system that is designed to secure hard galvanized steel fasteners to cardboard or composite panels. After this 'pre-nailing', padding and cover are applied, then the panel can be securely nailed to furniture frame using a mallet.

Applications:

- Securing upholstery panels to the frame

Material Thickness:

- .180 Max, CardBoard
- .094 Max, Chip Board
- .094 Max, Plywood

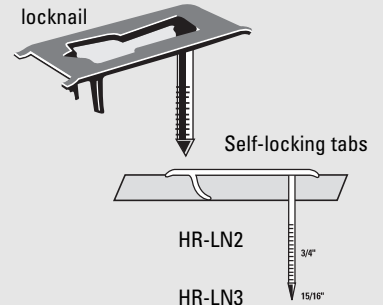

REFER TO LOCKNAIL™ SECTION ON PAGE 52



TR201, TR203, TR315

Attach Edge Roll to Border Wire

Features:

- TR201 Spring returned tool
- TR203 Spring returned tool long mag.
- TR315 High Speed air return, long mag. Magazine can be pivoted in 90° increments

Applications:

- Attaching edge roll to border wire

Tool Description:

- 15 ga. 3/4 D ring, 1/4 inch min. closure
- Short Magazine: 50 rings, 3.3 lbs.
- Long Magazine: 100 rings, 3.6 lbs.

15-Gauge D-Ring

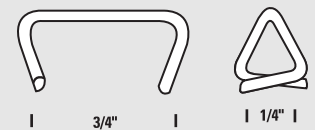

Available in: Basic Steel, galvanized, stainless

REFER TO #5 ON PAGES 54 & 55



S32SX, S32SL, SX150, SL150

Production Finish and Trim Stapler

Features: S32SX, S32SL Extreme Duty:

- Extreme-duty, high cycle design (requires oil)
- Composite frame/Aluminum magazine
- Narrow nose for improved line of sight

Features: SX150, SL150 Oil Free:

- Oil-free engine
- Magnesium frame composite magazine
- Narrow nose for improved line of sight
- Ultra-quiet, rear exhaust
- Auto-fire options: BTSXAF-125-KIT and BTSXAF-200-KIT
- Long magazine versions (2x capacity) SX150LM, SL150LM

Applications:

- High production finish and trim
- Frame assembly - corner blocks, stretchers

Tool Description:

- **S32SX**
- Tool Weight: 2.4 lbs.
- Driving Pwr: 145 inch lbs. @ 100 psi
- **S32SL**
- Tool Weight: 2.5 lbs.
- Driving Pwr: 160 inch lbs. @ 100 psi
- **SX150**
- Tool Weight: 2.5 lbs.
- Driving Pwr: 170 inch lbs. @ 100 psi
- **SL150**
- Tool Weight: 2.5 lbs.
- Driving Pwr: 170 inch lbs. @ 100 psi

18-Gauge SX Staple

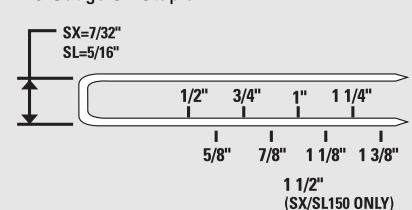

REFER TO SX SERIES ON PAGE 51



BT35, BT50, BT125, BT200

Decorative Trim, Corner Block Nailer

Features: BT35B, BT50B Extreme Duty

- Extreme-duty, high cycle design (requires oil)
- Composite frame / Aluminum magazine
- Narrow nose for improved line of sight

Features: BT125, BT200 Oil-free

- Oil-free engine
- Magnesium frame composite magazine
- Narrow nose for improved line of sight
- Ultra-quiet, rear exhaust
- Auto-fire options: BTSXAF-125-KIT and BTSAF-200-KIT

Applications:

- Decorative molding, fine trim work

Tool Description:

- **BT35B**
- Tool Weight: 2.4 lbs.
- Driving Pwr: 145 inch lbs. @ 100 psi
- **BT125**
- Tool Weight: 1.9 lbs.
- Driving Pwr: 145 inch lbs. @ 100 psi
- **BT50B**
- Tool Weight: 2.6 lbs.
- Driving Pwr: 165 inch lbs. @ 100 psi
- **BT200**
- Tool Weight: 2.1 lbs.
- Driving Pwr: 170 inch lbs. @ 100 psi

18-Gauge Brad

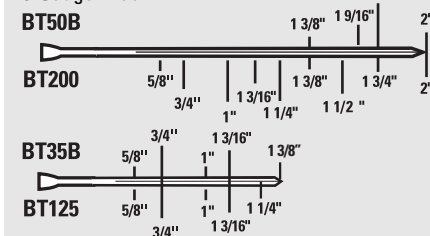

REFER TO BT SERIES ON PAGE 47

216 Series

Fabric to Wood Assembly

Features:

21671B:

- Very lightweight, rugged, all metal construction, quiet, low air consumption

21671B-LN:

- Same as 21671B but with extended nose for greater visibility and access to hard-to-reach areas
- Long nose also helps prevent scarring and scratching of wood

21671B-A:

- 2-function trigger light squeeze for single fire mode; full squeeze for auto-fire mode
- Auto fire rate can be adjusted from 0 to 1600 staples/minute
- Same hand that activates trigger also opens magazine, allowing for new staple insertion with the free hand

21671B-ALM:

- Same as 21671B-A but w/long magazine (392 Staples) 21680B, 21680B-LN (long nose)
- Same as 21671B but fires 80 series staples
- 21697B Attaching double welt



Applications:

- Securing fabric to wood frame
- Pre-upholstery spring-up operation attach cardboard, webbing, Propex to frame
- Boat seating with stainless steel staples

Tool Description:

21671B

- Tool Weight: 1.8 lbs.
- Magazine Capacity: 196, 71 series staples

21697B

- Tool Weight: 1.9 lbs.
- Magazine Capacity: 156, 97 series staples

21671B-LN

- Tool Weight: 2.1 lbs.
- Magazine Capacity: 196, 71 series staples

21671B-A

- Tool Weight: 2.6 lbs.
- Magazine Capacity: 196, 71 series staples

21671B-ALM

- Tool Weight: 3.0 lbs.
- Magazine Capacity: 392, 71 series staples

21680B, 21680B-LN, 21680B-ALM

- Tool Weight: 1.8 lbs.
- Magazine Capacity: 156, 80 series staples

71 Staple

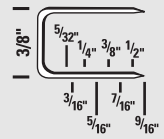

80 Staple

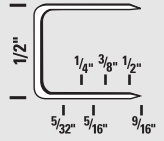

97 Staple

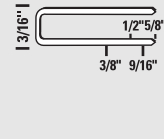

N62FN, N52FN

Decorative Trim Nailer

Features:

N62FN:

- Oil free engine requires no lubrication and leaves no oil stains on work
- Tool-free removable magazine for fast cleaning and jam clearing

N52FN:

- Oil free engine requires no lubrication and leaves no oil stains on work
- Tool-free removable magazine for fast cleaning and jam clearing



Applications:

- Decorative trim, finished wood panels

Tool Description:

N62FN, N52FN:

- Tool Weight: 3.8 lbs.
- Driving Power: 400 inch lbs. @ 100 psi
- Magazine Capacity: 100

Also see straight 16-Gauge finish nailer FN16250 on page 32.

REFER TO 71, 80 SERIES ON PAGES 50

15-Gauge Finish Nail



16-Gauge Finish Nail



Available in: Coated, stainless steel, aluminum

REFER TO FN15 SERIES ON PAGE 48

450S2

Furniture Packaging / Frame Assembly Stapler

Features:

- Lightweight durable aluminum frame
- Anti-Jam magazine
- Power control valve, adjusts power by 30%
- Overmolded rubber comfort grip
- Reduced height for stapling in tight areas
- Rear exhaust directs exhaust away from user and work surface
- High capacity, top-load magazine decreases reload time
- **ESD-450S2-WS** 450S2 with 22 1/2" extended handle available for easy fastening of boxes to pallets



Applications:

- Furniture packaging: corrugated boxes to wood
- Frame Assembly, bridge joints

Tool Description:

- Tool Weight: 4.6 lbs.
- Driving Power: 230 inch lbs. @ 100 psi
- Magazine Capacity: 160
- 1/2 to 2 inch leg

16-Gauge S2 Staple

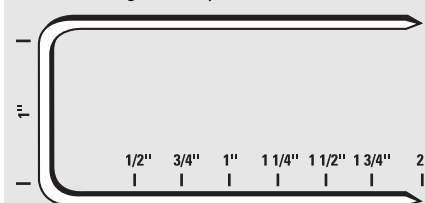

Available in: Coated

REFER TO 16 S2 SERIES ON PAGE 50

CASE GOODS

750S4
750S5
438S2

438S4
MCF16
650S4

650S5
BA-T156
N62FN

CF152
HP118K
TU-225-18HP

FN16250
S32SL
S32SX
S3297

SX150
SL150
N52FN

BT-35B
BT50B
BT125
BT200



18-gauge SX staples
building drawers



CF15 Applying corrugated
fastener to an angled butt joint



18-gauge brads fastening
quarter round



There's a quality Bostitch® fastener for every application.
Check out our Fastener - Tool Selection Guide on pages 46-51.



Caseback being secured with
18-gauge SL staples



18-gauge brads applying trim



16-gauge nails securing a
cabinet face

438S2, 438S4

Packaging, Corner Connection Stapler

Features:

- Lightweight, molded lifetime comfort grip, reduced height for work in tight areas
- 30% adjustment in power with turn of valve
- Rear exhaust directs exhaust away from user and work surface
- Adjustable trip-positive staple depth control



438S4 Shown

Applications:

- S2 Packaging, corrugated containers to pallets
- S4 Corner connections, frames

Tool Description:

S2

- Tool Weight: 4.5 lbs.
- Driving Power: 230 inch lbs. @ 100 psi
- Magazine Capacity: 160
- 1/2 to 1-1/2 inch leg

S4

- Tool Weight: 4.05 lbs.
- Driving Power: 230 inch lbs. @ 100 psi
- Magazine Capacity: 160
- 1/2 to 1-1/2 inch leg

16-Gauge S2 Staple

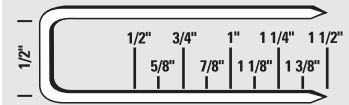
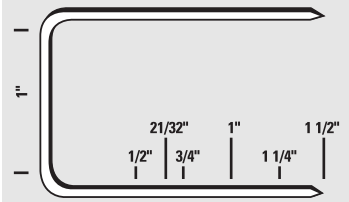

16-Gauge S4 Staple

Available in: Coated

REFER TO 16 S2, S4 SERIES ON PAGE 50

650S4, 650S5

Door, Window Frame Stapler

Features:

- Increases power to countersink staples into dense hardwood
- Long narrow nose for improved line of sight
- Overmolded rubber grip maximizes comfort
- Adjustable exhaust directs exhaust away from user
- Adjustable depth guide



Applications:

- Door and window frames

Tool Description:

- Tool Weight: 4.5 lbs.
- Driving Power: 340 inch lbs. @ 100 psi
- Magazine Capacity: S4: 160, S5: 171
- 1 to 2 inch leg

16-Gauge S4 Staple

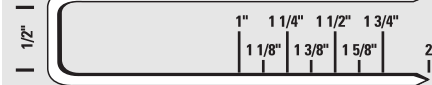

16-Gauge S5 Staple

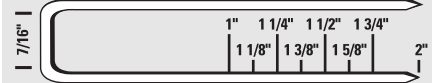

Available in: Coated

REFER TO 16 S4, S5 SERIES ON PAGE 50

750S4, 750S5

Heavy Duty Assembly Stapler

Features:

- Powerful engine for driving into hardwood
- Anti-Jam™ breathing magazine permits staple to exit nose without jamming
- Long narrow nose for improved line of sight
- Adjustable trip for positive staple depth control
- Multi direction exhaust and comfort grip



Applications:

- Heavy duty structural assembly

Tool Description:

- Tool Weight: ~5.3 lbs.
- Driving Power: 465 inch lbs. @ 100 psi
- Magazine Capacity: 160
- Long Magazine: 300 +
- 1-1/2 to 2 inch leg

16-Gauge S4 Staple



16-Gauge S5 Staple

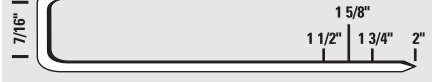

Available in: Coated

REFER TO 16 S4, S5 SERIES ON PAGE 50

S3297

Decorative Molding, Fine Trim Stapler

Features:

- Lightweight ergonomic, designed handle
- Fast trigger stroke



Applications:

- Decorative molding, fine trim work
- Drawer blocks, bottoms, guides

Tool Description:

- Tool Weight: 2.5 lbs.
- Driving Power: 160 inch lbs. @ 100 psi
- Magazine Capacity: 100

20-Gauge 97 Staple

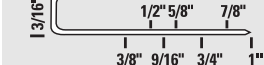

Available in: Coated

REFER TO 97 SERIES ON PAGE 50

S32SX, S32SL, SX150, SL150



Trim Work Cabinet Case Stapler

Features S32SX, S32SL Extreme Duty:

- Extreme-duty, high cycle design (requires oil)
- Composite frame/Aluminum magazine
- Narrow nose for improved line of sight

Features SX150, SL150 Oil-free:

- Oil-free engine
- Magnesium frame composite magazine
- Narrow nose for improved line of sight
- Ultra-quiet, rear exhaust
- Auto-fire options: BTSXAF-125-KIT and BTSXAF-200-KIT
- Long magazine versions (2x capacity) SX150LM, SL150LM

Applications:

- SX Trim work, drawers, cleat attachment, pin tenon joints, drawer stop blocks
- SL Case backs, metal guides

Tool Description:

- S32SX**
- Tool Weight: 2.5 lbs.
 - Driving Pwr: 160 inch lbs. @ 100 psi
- SX150**
- Tool Weight: 2.5 lbs.
 - Driving Pwr: 170 inch lbs. @ 100 psi
- S32SL**
- Tool Weight: 2.5 lbs.
 - Driving Pwr: 160 inch lbs. @ 100 psi
- SL150**
- Tool Weight: 2.5 lbs.
 - Driving Pwr: 170 inch lbs. @ 100 psi

18-Gauge SX Staple

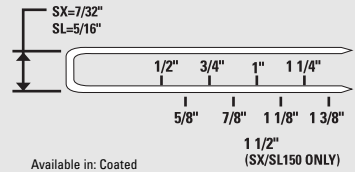

Available in: Coated

Model	Fastener Range	Weight (lbs.)	Power (in.-lbs.) @100psi
S32SX	1/2" - 1 3/8"	2.5	160
SX150	1/2" - 1 1/2"	2.5	170
S32SL	1/2" - 1 3/8"	2.5	160
SL150	1/2" - 1 1/2"	2.5	170

REFER TO SX, SL SERIES ON PAGE 51



N62FN, N52FN

Trim Work, Drawers, Cabinet Nailer

Features:

- Oil-free engine requires no lubrication
- Tool-free removable magazine

Also see page 32, FN16250 16-gauge straight finish nailer.

Applications:

- Trim work, drawers, cabinets

Tool Description:

- Tool Weight: 3.8 lbs.
- Driving Power: 400 inch lbs. @ 100 psi
- Magazine Capacity: 130
- 1 to 2-1/2 inch 15-ga. Finish nail

16-Gauge Finish Nail



15-Gauge Finish Nail



Available in: Coated, stainless steel, aluminum

REFER TO FN15 SERIES ON PAGE 48



BT35B, BT50B, BT125, BT200

Extremor Duty Decorative Molding, Fine Trim Nailer

Features BT35B, BT50B Extreme Duty:

- Extreme-duty, high cycle design (requires oil)
- Composite frame/Aluminum magazine
- Narrow nose for improved line of sight

Features BT125, BT200 Oil-free:

- Oil-free engine
- Magnesium frame composite magazine
- Narrow nose for improved line of sight
- Ultra-quiet, rear exhaust
- Auto-fire options: BTSXAF-125-KIT and BTSXAF-200-KIT

Applications:

- Decorative molding, fine trim work
- Drawer, pinning French and other dovetail joints

Tool Description:

- BT35B**
- Tool Weight: 2.4 lbs.
 - Driving Pwr: 145 inch lbs. @ 100 psi
- BT125**
- Tool Weight: 1.9 lbs.
 - Driving Pwr: 145 inch lbs. @ 100 psi
- BT50B**
- Tool Weight: 2.6 lbs.
 - Driving Pwr: 165 inch lbs. @ 100 psi
- BT200**
- Tool Weight: 2.1 lbs.
 - Driving Pwr: 170 inch lbs. @ 100 psi

18-Gauge Brad

BT50B

BT200

BT35B

BT125

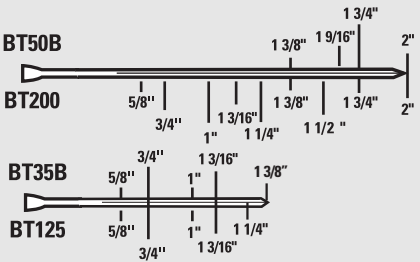

Available in: Coated

REFER TO BT SERIES ON PAGE 47



Door, Cabinet Mitre Nailer

Features:

- Lightweight

Applications:

- Joining door stiles, cabinet face frames
- Stile assembly, door window fabrication

Tool Description:

- CF15**
- Tool Weight: 6.58 lbs.
 - Magazine Capacity: 128
- MCF16**
- Tool Weight: 4.75 lbs.
 - Magazine Capacity: 156

Corrugated For: CF15

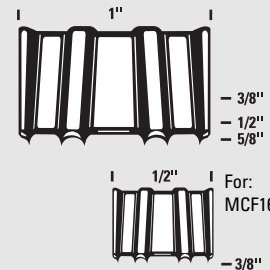

REFER TO CORRUGATED FASTENERS SECTION ON PAGE 49



TU-225-18HP, HP118K

18- & 23-Gauge Headless Pinner

Features:

- Adjustable high/low power control
- Lightweight, durable aluminum housing
- Overmolded grip
- Rear exhaust

Applications:

- Decorative molding, fine trim

Tool Description:

- TU-225-18HP (18-GAUGE)**
- Tool Weight: 2.3 lbs
 - Magazine Capacity: 230
- HP118K (23-GAUGE)**
- Tool Weight: 2.3 lbs
 - Magazine Capacity: 230

18-Gauge Headless Pin

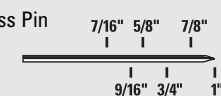

23-Gauge Headless Pin

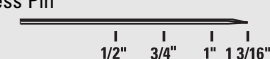

REFER TO 18-GA & 23-GA HEADLESS PIN SECTION ON PAGE 49

Fast, accurate, cost-effective manufactured housing relies on Bostitch® tools and fasteners.

Framing

F21PL	863S4
F28WW	538S214
N80CB	F33PT
MCN150	MCN250
640S4	
BIGBERTA160-2	
538S214-1	

Flooring / Underlayment

863S4	SX150
S32SX	SL150
S32SL	

Sheathing / Siding

N58C	650S4
F21PL	650S5
F28WW	750S5
N80CB	US056-1
SB150SLBC	650S414Kit
538S4	N66BC

Roofing

450S2
RN46
438S2R
US056
SB150SLBC

Cabinet / Trim

BT35B
BT50B
N62FN
S32SX
N52FN
BT125
BT200



538S214-1 With 14-gauge staples stitching truss joint and truss plate prior to roller press



F28WW Assembling 2" x 4" stud wall

There's a quality Bostitch® fastener for every application. Check out our Fastener - Tool Selection Guide on pages 46-51.



up to
2X the Resistance
to High Winds

Rated for hurricane wind conditions
and gusts up to 170 MPH

up to
50% More Resistant
to Earthquake Forces

Reduces the potential for major
structural damage



MCN150 Fastening Hurricane Strap
to framing joists



N66C Applying C4DCSBALG Ballistic Point
Nail to steel stud



Easy-To-Identify Head

- Marked for easy identification during code inspection

Up to 25% Larger Effective Head Area (Patented)

- Increases pull-through resistance
- Designed to decrease overdrive

Shear Shank Technology (Patent Pending)

- Screw shank fills voids in sheathing created by rings
- Smooth shank provides increased shear strength at primary stress point

Improved Plastic Collation

- Drives nails more smoothly
- Reduces flagging to ensure nails sink flush

Deep Ring Technology

- Ring shank delivers outstanding holding power



F21PL
FRAMING NAILER

COMPATIBLE FRAMING TOOLS:		Length	Diameter	Shank	Finish	Qty
BOSTITCH	F21PL N88RH N88RH-2MCN	2 1/2"	0.131"	HQ Ring	Brite	4000
Hitachi	N90AC	2 1/2"	0.113"	HQ Ring	Brite	5000
Porter Cable	FR350MAG					
Senco	FramePro, 700XL FRH					
Ridgid	R350RHA					

F28WW

Stick Framing Nailer

Features:

- Patented push-button adjustable depth guide
- Lightweight magnesium design for durability
- Aggressive toe-nailing teeth for slip-resistant toe nailing



Applications:

- Framing, sheathing applications including engineered lumber

Tool Description:

- Tool Weight: 7.7 lbs.
- Driving Power: 1050 inch lbs. @ 100 psi
- Magazine Capacity: 100
- Uses wire collated stick nail

.113" to .131" diameter
28° Wire Collated Stick Nails

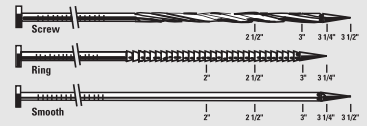

Available in: Plain, galvanized, stainless steel

REFER TO 28° WIRE STICK NAIL SECTION ON PAGE 49

F21PL, F33PT

Round Head Framing System

Features:

- Two nailers in one: includes two quick-change nosepieces to convert to either framing or metal connector nailer applications
- Patented push-button adjustable depth guide sets nails to desired depths
- Lightweight magnesium design for job site durability
- 1050 inch lbs. of driving power to tackle tough engineered lumber applications
- Molded rubber comfort grip designed to last longer



Applications:

- Framing, sheathing applications including engineered lumber
- Metal joist hanger and connectors

Tool Description:

- Tool Weight: 8.1 lbs.
- Driving Power: 1050 inch lbs. @ 100 psi
- Magazine Capacity: 60

113"-.162" diameter
21° Plastic Collated Stick Nails

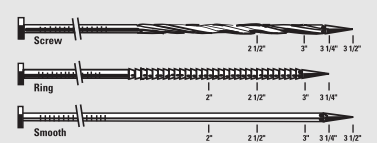

33° Paper Tape Collated Stick Nails
MCN (Metal Connector Nails)
Hardened .131", .162" Shank Diameter
1-1/2, 2-1/2 Length

Available in: Plain, galvanized, stainless steel

REFER TO THE PT, RH & S SERIES NAIL SECTIONS & THE PT & RH MC METAL CONNECTOR SECTIONS ON PAGES 48 & 49

MCN150, MCN250

Metal Connector Nailer

MCN150 Features:

- Compact design fits between 12", on center joists
- Low nail lockout prevents dry fires
- Exposed nail tip design fires in the hole for faster, more precise nailing
- Long magazine option



Applications:

- Fastening Metal Connectors & Strapping

Tool Description:

- Tool Weight: 4.6 lbs.
- Driving Power: 450 inch lbs. @ 100 psi
- Magazine Capacity: 29

35° Paper Collated Metal Connector Nail

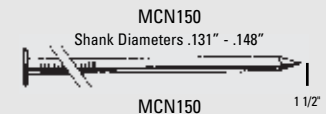

MCN250 Features:

- Low nail lockout prevents dry fires
- Exposed nail tip design fires in the hole for faster, more precise nailing
- Short magazine option

MCN250

- Tool Weight: 6.0 lbs.
- Driving Power: 600 inch lbs. @ 100 psi
- Magazine Capacity: 53

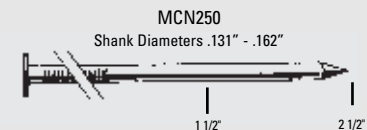

Available in: Plain, galvanized

REFER TO PT-MC SERIES NAIL SECTION ON PAGE 48

N80CB

Coil Framing Nailer

Features:

- Durable aluminum housing
- Quick-open composite canister survives falls
- Adjustable exhaust directs air away from user



Applications:

- Framing, sheathing

Tool Description:

- Tool Weight: 8.4 lbs.
- Driving Power: 880 inch lbs. @ 100 psi
- Magazine Capacity: 225 to 300 depending on nail size

15° Coil Nails

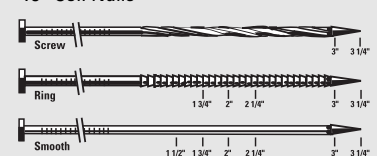

Available in: Plain, galvanized, stainless steel

REFER TO AC, C, FC NAIL SECTIONS ON PAGES 46 - 48



BIGBERTA160-2

Stick Timber Nailer

Features:

- Power-packed engine design drives nails up to 6-1/4 inches
- Oil-free, requires no lubrication
- Includes auxiliary handle for added comfort and control

Applications:

- Roof to ceiling connections
- Timber frames/log homes/pole barns

Tool Description:

- Tool Weight: 15.4 lbs.
- Driving Pwr: 2075 inch lbs. @ 100 psi
- Magazine Capacity: 50



Available in: Plain, galvanized, stainless steel

REFER TO 21° PLASTIC COLLATED SECTION ON PAGE 48 & 49



863S4

Flooring Stapler

Features:

- AntiJam™ magazine permits staples to exit nose without jamming
- Narrow nose for improved line of sight
- Adjustable trip for staple depth control

Applications:

- Flooring (plywood to frame)
- Sub-flooring

Tool Description:

- Tool Weight: 5.7 lbs.
- Driving Pwr: 570 inch lbs. @ 100 psi
- Magazine Capacity: 160
- Long Magazine: 260
- 1-1/2" to 2 inch leg

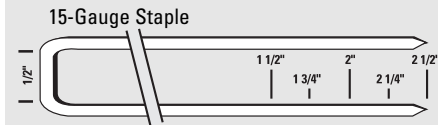
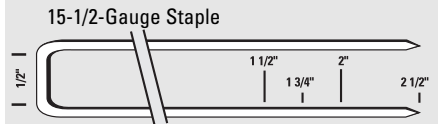

REFER TO 15 S4 & 15 1/2 S4 GAUGE SECTION ON PAGE 50



N58C-1

Box Frame Nailer

Features:

- Uses wire collated nails
- Durable cast aluminum frame and cap
- Oversized canister opens completely for fast loading

Applications:

- Pallets assembly and repair
- Fence panel assembly
- Crate assembly

Tool Description:

- Tool Weight: 5.7 lbs.
- Driving Power: 445 inch lbs. @ 100 psi
- Magazine Capacity: 300 to 350 depending on nail size
- 1 to 2-1/4 inch (2d to 7d)

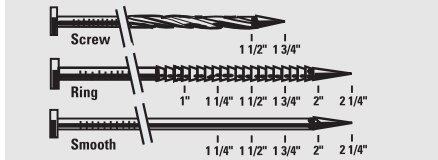

Available in: Plain, galvanized, stainless steel, aluminum

REFER TO AC, C, FC NAIL SECTION ON PAGES 46 - 48



538S4, 538S214-1

Stapler, Truss Stapler

Features:

- AntiJam™ magazine permits staples to exit nose without jamming
- Long narrow nose for improved line of sight
- Adjustable trip for positive staple depth control

Applications:

- Sheathing (1 1/2 inch leg)
- Truss Assembly

Tool Description:

- Tool Weight: 4.7 lbs.
- Driving Pwr: 260 inch lbs. @ 100 psi
- Magazine Capacity: 160
- Two-In-One Truss Tool
- Stitches truss joints
- Attaches truss plates prior to roller press

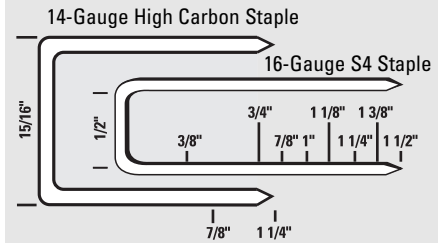

REFER TO 14, 16 S4 STAPLE SECTION ON PAGE 50



650S4, 650S5

Sheathing, Siding Stapler

Features:

- AntiJam™ magazine
- Overmolded rubber grip maximizes comfort
- Adjustable depth guide sets staples to desired depth
- Long narrow nose for improved line of sight

Tool Description:

- 650S4
- Tool Weight: 4.7 lbs.
- Driving Pwr: 340 inch lbs. @ 100 psi
- Magazine Capacity: 160
- Long Magazine: 300
- 1 to 2 inch leg
- Vinyl siding trip for 650S4 - part# 108551
- 650S5
- Tool Weight: 4.7 lbs.
- Driving Pwr: 340 inch lbs. @ 100 psi
- Magazine Capacity: 160
- Long Magazine: 300
- 1 to 2 inch leg

Applications:

- Sheathing applications requiring up to 2 inch staple legs
- 650S414KIT available to drive 14GA high carbon staples through strapping

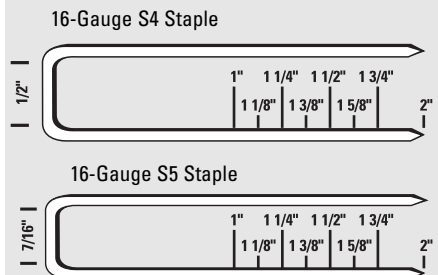

Available in: Coated

REFER TO 16 S4, S5 SERIES ON PAGE 50

750S5

Sheathing Stapler

Features:

- AntiJam™ breathing magazine permits staples to exit nose without jamming
- Comfort molded grip
- Long narrow nose for improved line of sight
- Adjustable trip for positive depth control

Applications:

- Sheathing applications requiring up to 2 inch staple legs

Tool Description:

- Tool Weight: 5.3 lbs.
- Driving Power: 465 inch lbs. @ 100 psi
- Magazine Capacity: 160 Long Magazine: 300
- 1 1/2 to 2 inch leg

16/17-Gauge Staple

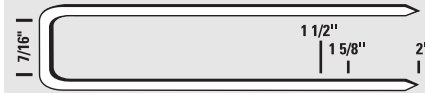

REFER TO 17 S5 STAPLE SECTION ON PAGE 50

US056-1

Pneumatic PowerCrown™ Stapler

Features:

- Pneumatic operation for high production felt, insulation and other light-wire stapling applications
- Lightweight magnesium design
- Oil-free operation requires no regular maintenance and eliminates risk of oil stains
- Ultra-quiet rear exhaust
- Molded rubber comfort grip designed to minimize fatigue

Applications:

- Roofing felt, housewrap vapor barrier application

Tool Description:

- Tool Weight: 2.1 lbs.
- Driving Power: 138 inch lbs. @ 100 psi
- Magazine Capacity: 84
- 1/4 to 9/16 inch leg

Bostitch® PowerCrown™ Staples STCR5019 Series

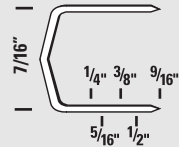

REFER TO STCR5019 SERIES ON PAGE 51

450S2, 438S2R

Roofing Stapler

Features:

- Lightweight durable aluminum frame
- Anti-Jam™ magazine
- Power control valve, adjusts power by 30%
- Molded rubber comfort grip designed to minimize fatigue
- Reduced height for stapling in tight areas
- Rear exhaust directs exhaust away from user
- High-capacity, top load magazine decreases reload time
- Carbide inserts for long life (438S2R)
- 438S2R has adjustable shingle gauge for fast layout

Applications:

- 450S2
 - Shingles; roofing felt, housewrap, vapor barrier, butt joints, hurricane strapping
- 438S2R
 - Composite shingle roofing
 - Housewrap, vapor barrier
 - Sheathing

Tool Description:

- 450S2**
 - Tool Weight: 4.6 lbs.
 - Driving Power: 230 inch lbs. @ 100 psi
 - Magazine Capacity: 160
 - 1/2 to 1-1/2 inch leg
- 438S2R**
 - Tool Weight: 4.7 lbs.
 - Driving Power: 230 inch lbs. @ 100 psi
 - Magazine Capacity: 160
 - 1/2 to 2 inch leg

16-Gauge Staple

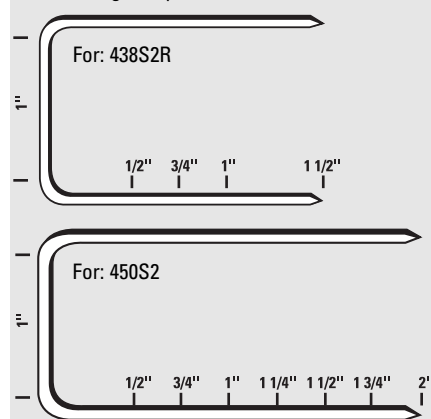

REFER TO 16 S2 SECTION ON PAGE 50

SB150SLBC-1

BOSTITCH® Cap Stapler Kit

Features:

- Uses wider 5/16" staples that help prevent puncture to the cap
- Adjustable depth guide
- Lightweight aluminum design
- Kit includes: tool, carry case, oil, wrench, 1000 Bostitch® caps and 1000 staples

Applications:

- Securely fastens most construction fabrics and foam insulation to sheathing

Tool Description:

- SB150SLBC-1**
 - Tool Weight: 4.7 lbs.
 - Driving Power: 300 inch lbs. @ 100 psi

18-Gauge SL Staple

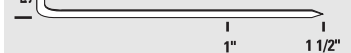

REFER TO SL SERIES ON PAGE 51

N66BC-1

BOSTITCH® Cap Nailer Kit

Features:

- Uses wire weld and plastic inserted coil nails
- Adjustable depth guide
- Lightweight magnesium design
- Quick-load magazine
- Kit includes: tool, carry case

Applications:

- Securely fastens most construction fabrics and foam insulation to sheathing

Tool Description:

- N66BC-1**
 - Tool Weight: 6.1 lbs.
 - Driving Power: 500 inch lbs. @ 100 psi



REFER TO C SERIES NAIL SECTION ON PAGE 47

* Uses same c series nails as N66C





RN46

Roofing Nailer

Features:

- Lightweight magnesium housing for job site durability
- Aggressive wear guards and skid pads
- Carbide-inserts for long life
- Zero nail lockout eliminates dry firing
- Patented single action side load canister
- 410 in.-lbs. of driving energy for the hardest of applications
- Quick-set adjustable depth guide sets nails to desired depths
- Overmolded grip for comfortable use
- Adjustable shingle guide for quick shingle spacing
- Full round driver for more consistent drive quality

Applications:

- Roofing/exterior drywall

Tool Description:

- Tool Weight: 4.8 lbs.
- Driving Pwr: 410 inch lbs. @100 psi

Accessories:

Vinyl siding attachment VSA4



15° Coil Nail

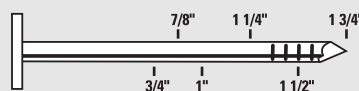

Available in: Galvanized, Stainless Steel

REFER TO COLLATED ROOFING NAIL SECTION ON PAGE 47



S32SX, S32SL, SX150, SL150

Cabinet, Underlayer Stapler

Features S32SX, S32SL Extreme Duty:

- Extreme-duty, high cycle design (requires oil)
- Composite frame/aluminum magazine
- Narrow nose for accurate fastener placement

Features SX150, SL150 Oil-free:

- Oil-free engine
- Magnesium frame composite magazine
- Narrow nose for improved line of sight
- Ultra-quiet, rear exhaust
- Auto-fire options: BTSXAF-125-KIT and BTSXAF-200-KIT
- Long magazine versions (2x capacity) SX150LM, SL150LM

Applications:

- Cabinet work
- Underlayerment: (1/4" luan under vinyl flooring)

Tool Description:

- S32SX**
 - Tool Weight: 2.5 lbs.
 - Driving Pwr: 160 inch lbs. @100 psi
- SX150**
 - Tool Weight: 2.5 lbs.
 - Driving Pwr: 170 inch lbs. @100 psi
- S32SL**
 - Tool Weight: 2.5 lbs.
 - Driving Pwr: 160 inch lbs. @100 psi
- SL150**
 - Tool Weight: 2.5 lbs.
 - Driving Pwr: 170 inch lbs. @100 psi

18-Gauge SX/SL Staple

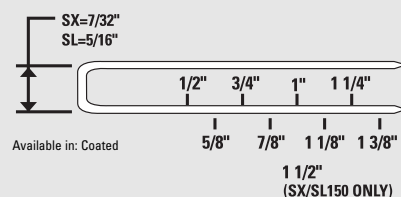

Available in: Coated

REFER TO SX SERIES ON PAGE 51



BT35B, BT50B, BT125, BT200

Decorative Molding, Fine Trim Nailer

Features BT35B, BT50B Extreme Duty:

- Extreme-duty, high cycle design (requires oil)
- Composite frame aluminum magazine
- Narrow nose for improved line of sight

Features BT125, BT200 Oil-free:

- Oil-free engine
- Magnesium frame composite magazine
- Narrow nose for improved line of sight
- Ultra-quiet, rear exhaust
- Auto-fire options: BTSXAF-125-KIT and BTSXAF-200-KIT

Applications:

- Decorative molding, fine trim work
- Drawer; pinning French and other dovetail joints

Tool Description:

- BT35B**
 - Tool Weight: 2.4 lbs.
 - Driving Pwr: 145 inch lbs. @100 psi
- BT125**
 - Tool Weight: 1.9 lbs.
 - Driving Pwr: 145 inch lbs. @100 psi
- BT50B**
 - Tool Weight: 2.6 lbs.
 - Driving Pwr: 165 inch lbs. @100 psi
- BT200**
 - Tool Weight: 2.1 lbs.
 - Driving Pwr: 170 inch lbs. @100 psi

18-Gauge Brad

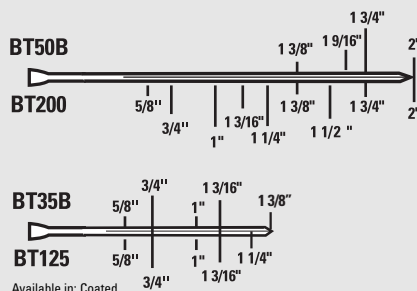

Available in: Coated

REFER TO BT SERIES ON PAGE 47



N62FN, N52FN

Trim Work, Drawers, Cabinet Nailer

Features:

- Oil-free engine requires no lubrication
- Tool-free removable magazine

Also see page 32, FN16250 16-gauge finish nailer.

Applications:

- Trim work, drawers, cabinets

Tool Description:

- Tool Weight: 3.8 lbs.
- Driving Power: 400 inch lbs. @ 100 psi
- Magazine Capacity: 130
- 1 to 2-1/2 inch 15-ga. Finish nail

16-Gauge Finish Nail



15-Gauge Finish Nail

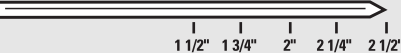

Available in: Coated, stainless steel, aluminum

REFER TO FN SERIES ON PAGE 48

There's no sleeping allowed on this job. Hard-working employees need tools that perform all-day and night.

Box Frame Assembly:
N58C-1
438S4
438S5
BCAR1B-495-92L
BCAR-2S

Borderwire to Innerspring:
HR-48CCP
HR-49CCP
VRC Machine
HR-85-Series
Coil Clip System

Fabric to Wood:
21671B
21671B-LM
21680B

Fabric to Foam:
SL1250C-2

Flange to Spring:
SC7
SC7C
TR201
TR203
TR315



BCAR-2S Stapler foundation spring to flat



SC7 With manifold kit SCK014 securing pocketed coils w/C-Ring



438S4 Stapler connecting flat members



SL1250C-2 Flange stapler applying flange to foam side



TR203 D-Ring tool connecting flange to innerspring



Coil clip system and vertical rotating clip machine securing innersprings to borderwire

There's a quality Bostitch® fastener for every application. Check out our Fastener - Tool Selection Guide on pages 46-51 in the back of the catalog.



N58C-1

Box Frame Nailer

Features:

- Uses wire collated nails
- Durable cast aluminum frame and cap
- Oversized canister opens completely for fast loading

Applications:

- Pallets assembly and repair
- Fence panel assembly
- Crate assembly

Tool Description:

- Tool Weight: 5.7 lbs.
- Driving Power: 445 inch lbs. @ 100 psi
- Magazine Capacity: 300 to 350 depending on nail size
- 1 to 2-1/4 inch (2d to 7d)

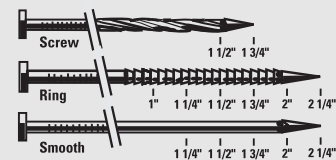

REFER TO AC, FC SERIES ON PAGE 46 - 48



438S4, 438S5

Box Frame Stapler

Features:

- Lightweight durable aluminum frame
- Jam-free magazine
- Power control valve, adjusts power by 30%
- Long-lasting molded rubber comfort grip
- Reduced height for stapling in tight areas
- Rear exhaust directs exhaust away from user and work surface
- High-capacity, top load magazine decreases reload time

Applications:

- Box frame/flat assembly

Tool Description:

- Tool Weight: 4.6 lbs.
- Driving Power: 230 inch lbs. @ 100 psi
- Magazine Capacity: 160
- 1/2 to 1-1/2 inch leg

16- Gauge S4 Staple

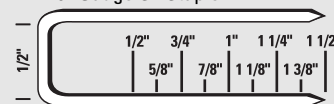

16- Gauge S5 Staple

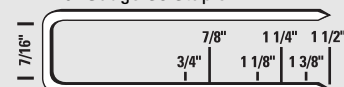

Available in: Coated

REFER TO 16 S4 STAPLE SECTION ON PAGE 50



BCAR1B-495-92L, BCAR-2S

Attaching Spring to Box Frame

Features:

- Pneumatic stapler for driving staples into hard-to-reach places such as bottoms of coil springs
- Available in single or double staple fire versions

Applications:

- Spring up (attaching springs to box frame)

Tool Description:

- Tool Weight: 7.4 lbs.
- Magazine Capacity: 100
- Staple Length: 3/4 inch

BSC31, BCS31P
16-Gauge Round
Crown Staple



BSC31 Collated with adjacent chisel points in same direction.

BCS31P Collated with adjacent chisel points in opposite directions.

REFER TO ROUND CROWN BOX SPRING SECTION ON PAGE 51



SC7, SC7C

Spring to Spring

Features:

- Balanced, lightweight, ergonomically designed
- Easy-to-load anti-back-up magazine
- Can be easily converted to right or left hand operation
- Manifold mounting kit available for zero gravity balancer suspension (vertical or horizontal): SCK014
- Zero gravity balancer: BAL5N

Applications:

- Pocket coil to pocket coil
- Pocket coil to borderwire
- Flange to innerspring/borderwire

Tool Description:

- Tool Weight: 2.8 lbs.
- Magazine Capacity: 125
- Jaw Length: 1-1/4 inch

RING15100P



Closure w/ SC7C Closure w/ SC7

Available in: Basic brite steel, galvanized, aluminum, stainless

REFER TO #3 ON PAGES 54 & 55

(Shown with balancer and manifold kit options)

TR201, TR203, TR315



Flange to Innersprings

Features:

- TR201 Spring returned tool
- TR203 Spring returned tool long mag.
- TR315 High-speed air return, long mag.
- Magazine can be pivoted in 90° increments on TR315, and continuously on TR201 and TR203

Applications:

- Flange to inner spring

Tool Description:

- 15 ga. 3/4 D rings, 1/4 inch min. closure
- Short Magazine: 55 rings, 3.3 lbs.
- Long Magazine: 125 rings, 3.6 lbs.

15-Gauge D-Ring

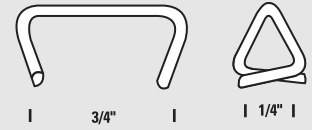

Available in: Basic Steel, galvanized, stainless

REFER TO #5 ON PAGES 54 & 55

HR-85C-110

Borderwire to Wire

Features:

- Clinching tool squeezes instead of folding the clip around wires
- Driver blade cleanly feeds a clip from the magazine, places it around the wires, and forms the clip into a tight strong wire bond.

Applications:

- Foundation/box spring assembly
- Border wire overlap connections
- Clip-on edge supports
- Rebuilding and custom sizes

Tool Description:

- Driving Power: 2000 inch lbs.
- Magazine Capacity: 25 to 45 collated clips

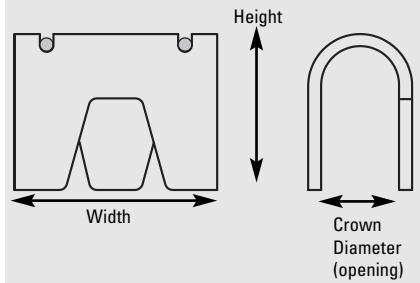

REFER TO CLIPS/CLIP TOOLS ON PAGES 52 & 53 AND CLIP SELECTION GUIDE ON PAGE 45

21671B, 21671B-LM, 21680B, 21680B-LN

Fabric to Wood Assembly

Features:

21671B:

- Very lightweight, rugged, all metal construction, quiet, low air consumption

21671B-LM:

- Same as BAT401 but with long magazine; cuts reloading time

21680B, 21680B-LN (long nose):

- Same as 21671B but fires 80 series staples

Applications:

- Securing fabric to wood frame
- Pre-upholstery spring up operation: attach cardboard, webbing, propex to frame
- Boat Seating with stainless steel staples
- 21697B Attaching double welt

Tool Description:

- **21671B**
- Tool Weight: 1.81 lbs.
- Magazine Capacity: 196, 71 series staples
- **21671B-LM**
- Tool Weight: 2.43 lbs.
- Magazine Capacity: 392, 71 series staples
- **21680B; 21680B-LN**
- Tool Weight: 1.83 lbs.
- Magazine Capacity: 156, 80 series staples

71 Staple

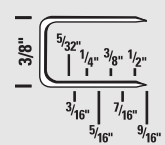

80 Staple

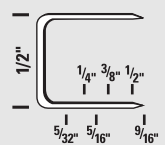

REFER TO 71, 80 SERIES STAPLE SECTION ON PAGE 50 & 51

SL1250C-2

Fabric to Foam Stapler

Features:

- Designed for staple legs to flare outward, giving good holding power in soft material

Applications:

- Fastening flange to foam encased innerspring
- Fabric to cardboard, foam
- Temporary pinning of fabric

Tool Description:

- Tool Weight: 2.8 lbs.
- Driving Power: 160 inch lbs. @ 100 psi
- Magazine Capacity: 100
- Staple Length: 1 inch typical (SL5031G)

SL Series: 5/16" Crown

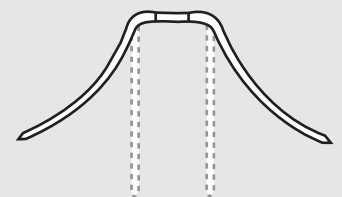

REFER TO SL SERIES ON PAGE 51

COIL CLIP SYSTEM

Borderwire Assembly

Features:

- Provides a simple and efficient means of attaching borderwire to innerspring units
- System allows operators to apply clips from a continuous clip coil at an average rate of 20,000 clips/8-hour shift

Tool Description:

System consists of:

- HR-55450 tool stand assembly
- HR-55435 dispenser and track assembly
- 132979 tool balancer
- HR-65002 3/8" hose assembly
- HR-65006 king size (86" x 72") rotating table
- HR-65007 full size (58" x 72") rotating table

Tools:

- HR-48CCP
- HR-49CCP

Applications:

- Pre-clipping operation: Attaching corners of borderwire to corners of innerspring assembly prior to full clipping by VRC Machine
- Can also be used to clip entire borderwire to innerspring assembly in low-volume operations



REFER TO COIL CLINCH CLIP 7/16" WIDE SECTION ON PAGE 52, AND CLIP SELECTION GUIDE ON PAGE 45

VRC MACHINE

Borderwire to Innersprings

Features:

- Used in conjunction with the coil clip system for clipping borderwire to sides of innerspring assemblies
- Clipping speed for Bonnel/Offset Bonnel and LFK coil assemblies is faster than previous VRC models. A single machine will now easily keep up with an experienced operator on the coil clip system.
- The process of clipping an innerspring is as follows: An innerspring is taken off the transfer/coiler by an operator and placed on the rotating work table. The operator retrieves two borderwires and positions them on the innerspring. They are attached to the perimeter corner coils using the Clip Tool. The unit is now pre-clipped and is taken off the table and placed on the VRC Machine. The operator presses the start button and the machine runs automatically to finish attaching the borderwires. While the machine clips the borderwires, the operator pre-clips another unit. The NEW faster VRC will finish clipping at the same time the operator finishes the second pre-clipping operation. The next pre-clipped unit is placed on the right side of the machine, the machine is started, and the first finished unit is unloaded.
- CE compliant option available
- Programmable in English and Spanish

Applications:

- Borderwire sides to innersprings

Machine Description:

- Tool Weight: 2000 lbs. (2500 lbs. crated)
- Magazine Capacity: 9375 to 15,625 clips per clipping head



REFER TO COIL CLIP 7/16" ON PAGE 52 AND CLIP SELECTION GUIDE ON PAGE 45

From decorative molding-fine trim work and even case backs, Bostitch has the industrial-strength pneumatic tool for the job.

Structural Assembly:

450S2
450S2
538S4
N58C-1
N62FN
N52FN
TU-225-18HP
HP118K
SX150
SL150
FN16250

Trim Work:

S32SX
S32SL
BT35
BT50
BT125
BT200

Door/Window Frames:

650S4
650S5
CF15
MCF16



There's a quality Bostitch® fastener for every application.
Check out our Fastener - Tool Selection Guide on pages 46-51.

Custom Millwork Calls for Premium Quality Tools and Fasteners.



450S2 Stapler joining door jambs



CF15 Corrugated tool applying mitre fastener to window frame



Applying 18-gauge brad to door casing



16-gauge finish nails connecting brick molding to a window frame

Fast, accurate and built to work... and work... and work.



TU-225-18HP, HP118K

18 & 23-Gauge Headless Pinner

Features:

- Adjustable high/low power control
- Lightweight, durable aluminum housing
- Overmolded grip
- Rear exhaust

Applications:

- Fine trim work

Tool Description:

- **TU-225-18HP (18 GAUGE)**
- Tool Weight: 2.3 lbs
- Magazine Capacity: 230
- **HP118K (23 GAUGE)**
- Tool Weight: 2.3 lbs
- Magazine Capacity: 230

18-Gauge Headless Pin

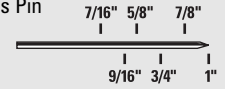

23-Gauge Headless Pin

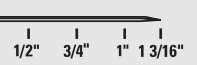

REFER TO 18-GA & 23-GA HEADLESS PIN SECTION ON PAGE 49



S32SX, S32SL

Cabinet, Underlayment Stapler

Features S32SX, S32SL: Extreme Duty:

- Extreme-duty, high cycle design (requires oil)
- Composite frame/aluminum magazine
- Narrow nose for improved line of sight

Features SX150, SL150: Oil Free:

- Oil-free engine
- Magnesium frame composite magazine
- Narrow nose for improved line of sight
- Ultra-quiet, rear exhaust
- Auto-fire options: BTSXAF-125-KIT and BTSXAF-200-KIT
- Long magazine versions (2x capacity) SX150LM, SL150LM

Applications:

- Cabinet work
- Underlayment: (1/4 luan under vinyl flooring)

Tool Description:

- Tool Weight: 2.5 lbs.
- Driving Pwr: 170 inch lbs. @ 100 psi
- Magazine Capacity: 100
- Long Magazine: 200
- 1/2 to 1-1/2 inch leg

18-Gauge SX Staple

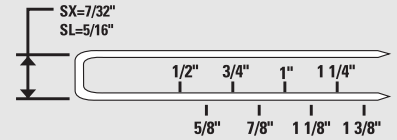

Available in: Coated

REFER TO SX SERIES ON PAGE 51



BT35B, BT50B, BT125, BT200

Extreme Duty Decorative Molding, Fine Trim Nailer

Features BT35B, BT50B Extreme Duty:

- Extreme-duty, high cycle design (requires oil)
- Composite frame aluminum magazine
- Narrow nose for improved line of sight

Features BT125, BT200 Oil-free:

- Oil-free engine
- Magnesium frame composite magazine
- Narrow nose for improved line of sight
- Ultra-quiet, rear exhaust
- Auto-fire options: BTSXAF-125-KIT and BTSXAF-200-KIT

Applications:

- Decorative molding, fine trim work
- Drawer, pinning French and other dovetail joints

Tool Description:

- **BT35B**
- Tool Weight: 2.4 lbs.
- Driving Pwr: 145 inch lbs. @ 100 psi
- **BT125**
- Tool Weight: 1.9 lbs.
- Driving Pwr: 145 inch lbs. @ 100 psi
- **BT50B**
- Tool Weight: 2.6 lbs.
- Driving Pwr: 165 inch lbs. @ 100 psi
- **BT200**
- Tool Weight: 2.1 lbs.
- Driving Pwr: 170 inch lbs. @ 100 psi

18-Gauge Brad

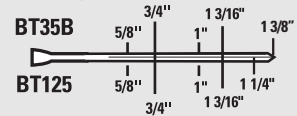

18-Gauge Brad

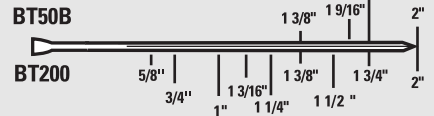

REFER TO FN15 SERIES ON PAGE 48



N62FN, N52FN

Finish Nailers

Features:

- Sequential trip
- Oil-free engine requires no lubrication
- Tool-free removable magazine

Applications:

- Structural assembly, casings, etc.
- Medium duty finish nail structural assembly

Tool Description:

- **N62FN / N52FN**
- Tool Weight: 3.7 lbs. / Same
- Driving Pwr: 330 inch lbs. @ 100 psi / Same
- Magazine Capacity: 130 / Same
- 1 to 2-1/2 inch 15-ga. Finish nail / 1 to 2 inch 16-ga. Finish nail

16-Gauge Finish Nail For N52FN:

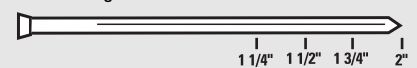

15-Gauge Finish Nail For N62FN:



Available in: Coated, stainless steel, aluminum

REFER TO FN15 SERIES ON PAGE 48



FN16250

Features:

- Lightweight magnesium design for added durability
- Oil-free operation requires no regular maintenance and eliminates the risk of oil stains
- Adjustable depth guide sets nails to desire depths quickly and conveniently
- Tool-free removable magazine for fast cleaning and jam-clearing

Applications:

- Interior finish/trim
- Door jams

Tool Description:

- Tool Weight: 3.8lbs.
- Driving Pwr: 400inch lbs. @ 100 psi.
- Magazine Capacity: 130
- 1 to 2-1/2 inch 16-ga. Finish nail

16-Gauge Finish Nail

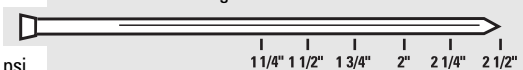

REFER TO FN15 SERIES ON PAGE 48



538S4

Medium Duty Structural Stapler

Features:

- Anti-Jam™ magazine permits staples to exit nose without jamming
- Narrow nose for improved line of sight
- Adjustable trip for positive staple depth control

Applications:

- Medium duty structural assembly

Tool Description:

- Tool Weight: 4.7 lbs.
- Driving Pwr: 280 inch lbs. @ 100 psi
- Magazine Capacity: 160
- 3/8" to 1-1/2 inch leg

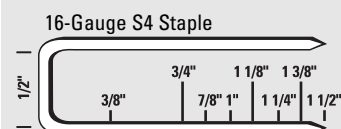

Available in: Coated

REFER TO 16 S4 SERIES ON PAGE 50



650S4, 650S5

Door, Window Frame Stapler

Features:

- Powerful engine for driving into hardwood
- Narrow nose for improved line of sight

Applications:

- S4: door and window frames
- S5: door and window frames

Tool Description:

- Tool Weight: 4.5 lbs.
- Driving Pwr: 340 inch lbs. @ 100 psi
- Magazine Capacity: S4: 160, S5: 171
- 1" to 2 inch leg

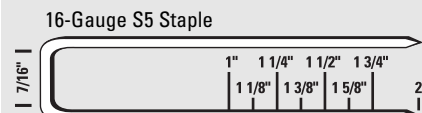
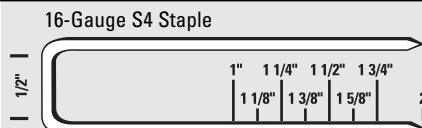

Available in: Coated

REFER TO 16 S4, S5 SERIES ON PAGE 50



450S2

Light Duty Structural Assembly Stapler

Features:

- Lightweight durable aluminum frame
- Jam-free magazine
- Power control valve, adjusts power by 30%
- Long-lasting molded rubber comfort grip
- Reduced height for stapling in tight areas
- High capacity, top load magazine decreases reload time

Applications:

- Light duty structural assembly

Tool Description:

- Tool Weight: 4.6 lbs.
- Driving Power: 230 inch lbs. @ 100 psi
- Magazine Capacity: 160
- 1/2 to 2 inch leg

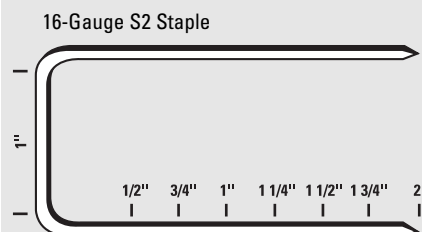

Available in: Coated

REFER TO 16 S4, S5 SERIES ON PAGE 50



N58C-1

Structural Assembly Nailer

Features:

- Lightweight, compact design

Applications:

- Structural assembly

Tool Description:

- Tool Weight: 5.6 lbs.
- Driving Power: 475 @ 100 psi
- Magazine Capacity: 300 to 350

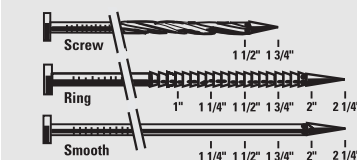

REFER TO A, AC, FC SERIES ON PAGES 46 THROUGH 48



CF15, MCF16

Door, Cabinet Mitre Nailer

Features:

- Lightweight

Applications:

- Joining door stiles, cabinet face frames
- Stile assembly, door window fabrication

Tool Description:

- CF15-2**
- Tool Weight: 6.58 lbs.
- Magazine Capacity: 128
- MCF16**
- Tool Weight: 4.75 lbs.
- Magazine Capacity: 156

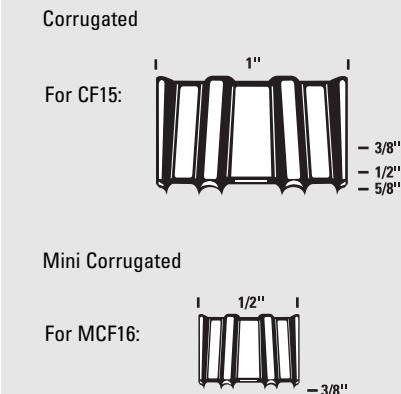

REFER TO CORRUGATED/MITRE FASTENER SECTION ON PAGE 49

CARTON CLOSURE

Companies thrive on getting the job in and then out. Bostitch has an extensive line of carton closure tools and fasteners to help get the boxes out the door.

P3-IND
P6C-6
P6C-8
P6C-8P

JB600
ESD-450S2P
P50-10B
P50-5B

PC3000
PC4000
F84
FC95EC

D16-2
D16-2AD
D61ADC
D61ADCSB

450S2
ESD-450S2-WS
02245



FC95EC Bottom closer used to clinch carton bottoms



P50-10B Fastening carton side



P6C-8P With pointed anvil piercing corrugated to seal container from outside



D61ADC Sealing carton lid

There's a quality Bostitch® fastener for every application. Check out our Fastener - Tool Selection Guide on pages 46-51.

BAG CLOSURE

From poultry to automotive parts, if it comes packaged in a bag, we have the closure to make sure it stays there.

P6C-8F

P7

HFP9

SC7

SC760

SC50T

SC761

SC743

SC7C



SC7 Equipped with MTCKA7 touch trip



Low cost P7 being used to seal potato bag



Bait bag secured with 15-gauge stainless steel C-ring

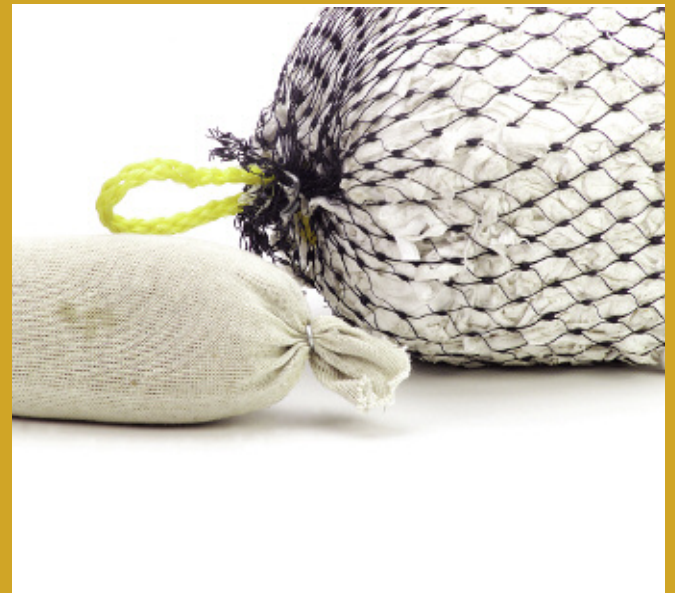

Oil absorption socks can be secured with 11, 15 or 16-gauge blunt C-rings

P3-IND



Tagging, Wrapping, Shipping

Features:

- Fine wire lightweight staple
- Top load magazine with cover/pusher that stays with the tool
- Rugged design for heavy use with moveable, breathing core to prevent jamming
- Pass-by clinch so one staple will fasten various thickness applications

Applications:

- Dry cleaner garment tagging, drugstore bag closure, price tag to garment, etc.
- Flower wrapping
- Badges and ribbons
- Shipping room packaging

Tool Description:

- Tool Weight: 0.5 lbs.
- Magazine Capacity: 208



P6C-6, P6C-8, P6C-8P, JB600

Box Closing, Dry Cleaning

Features:

P6C-8:

- Bearing system allows an easy squeeze action across entire operating sequence creating a quicker, tighter clinch with less strain
- Available in P-Pointed blade version (P6C-8P) to penetrate cartons to clinch staple (see photo page 36)
- Coated top-load magazine permits faster, smoother staple loading

P6C-6:

- Same as P6C-8 but with lighter wire staple

JB600:

- Air drive version of P6C-8 allows continuous use without stress
- Top loading magazine

Applications:

P6C-6:

- Fastening Header cards to plastic bags, etc.
- Assembling small cardboard boxes

Tool Description:

P6C-6

- Tool Weight: 1 lbs.
- Magazine Capacity: 158
- Throat Size: ~3/8" x 2-1/2"

P6C-8

- Tool Weight: 1 lbs.
- Magazine Capacity: 85
- Throat Size: ~3/8" x 2-1/2"
- Pneumatic assembly available

JB600

- Tool Weight: 2.4 lbs.
- Magazine Capacity: 85
- Throat Size: ~3/8" x 2-1/2"

Applications:

P6C-8:

- Header cards to plastic bags
- Box closing
- Corrugated assembly
- Dry cleaning

JB600:

- Lightweight manufacturing and packaging

REFER TO 3/8" CROWN STAPLE SECTION ON PAGE 51

Bostitch® Light Wire PowerCrown™ Staples
STCR2619 Series

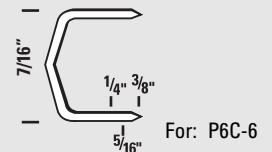

Bostitch® PowerCrown™ Staples
STCR5019 Series

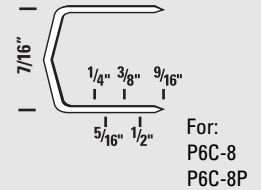

PC3000, PC4000

Temporary Fastening, Labels to Wood, Plastic

Features:

- Unique design turns staple legs outward after penetrating corrugated
- Patented easy squeeze design
- Patented drive system cuts force needed in half while delivering full penetration and drive consistency
- Heat-treated drive components for long life
- Ruled staple window allows operator to check staple leg length and verify if staples are in the tool



Applications:

- Temporarily fastening merchandise to corrugated or corrugated to corrugated (OC)
- Applying labels to wood, plastic

Tool Description:

PC3000

- Tool Weight: 2.2 lbs.
- Magazine Capacity: 84

PC3000- OC2

- Outward Clinch

PC4000

- Tool Weight: 1.97 lbs.

PC4000- OC1 / OC2

- Outward Clinch

REFER TO STCR2619 AND STCR5019 SECTIONS ON PAGE 51

For PC3000:



Bostitch® Light Wire PowerCrown™ Staples
STCR2619 Series

For PC4000:

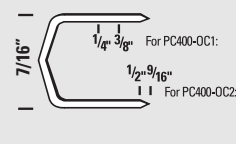

Bostitch® PowerCrown™ Staples
STCR5019 Series

Outward Clinch



REFER TO STCR2619 AND STCR5019 SECTIONS ON PAGE 51

F84

Low-Volume Carton Closing

Features:

- 16-1/2 throat depth and anvil post height of 36 inches allow most cartons to be stapled in one motion without reversing carton direction
- Will handle standard and heavy wire wide crown staples
- AntiJam™ interlock to prevent accidental jams, simple design for long life

Applications:

- Low-volume carton bottom closing

Tool Description:

- Tool Weight: 84 lbs.
- Magazine Capacity: 240 staples

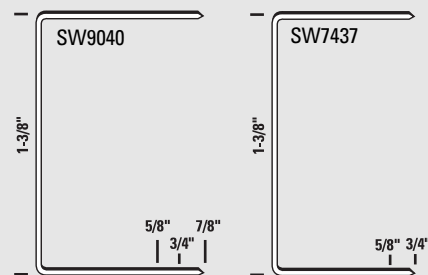

REFER TO 1-3/8" WIDE CROWN STICK STAPLE SECTION ON PAGE 51

FC95EC

High-Volume Carton Closing

Features:

- 24-inch throat and 40-inch anvil post height allow most cartons to be stapled in one motion without reversing carton direction
- 24-inch arm model (FC95ECARM) with clinching anvil coming off vertical post available for closing sidewalls, tray boxes and package fillers

Applications:

- High volume carton bottom closing

Tool Description:

- Tool Weight: 230 lbs.
- Coil of 4000/load
- 180 staples/min speed
- Motor 1/4 hp 1725 rpm, 115/230 VAC, 60 cycle, capacitive start
- Welded steel construction

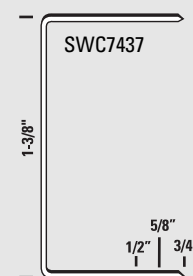

REFER TO 1-3/8" WIDE CROWN COIL PACKAGING STAPLE SECTION ON PAGE 51

D16-2, D19

Manual Container Sealing

Features:

- Ideal for application where the stapler must be taken to the work
- Penetrating clinchers are adjustable for either through or blind clinch stapling

Applications:

- Low-volume sealing of containers entirely from the outside

Tool Description:

- Tool Weight: 6.3 lbs.
- Magazine Capacity: 120 staples
- D16 takes "SW" staples
- D19 takes "B" staples

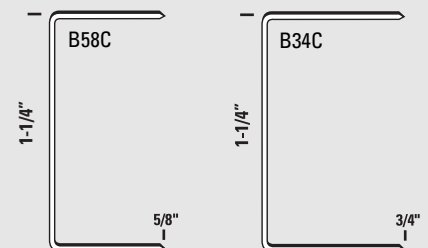

D16-2AD, D19AD, D19AD3/4

High-Volume Container Sealing

Features:

- Same as above but air driven
- Ideal for application where the stapler must be taken to the work
- Penetrating clinchers are adjustable for either through or blind clinch stapling

Applications:

- High-volume sealing of containers entirely from the outside

Tool Description:

- Tool Weight: 7.1 lbs.
- Magazine Capacity: 120 staples
- D16 takes "SW" staples
- D19 takes "B" staples

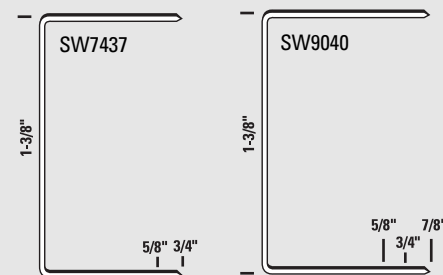

REFER TO 1-3/8" WIDE CROWN STICK STAPLE SECTION ON PAGE 51

D61ADC

Top Closure

Features:

- Drives the staple into corrugate at the same time two clincher arms penetrate on either side of staple legs, clinching staple
- Tool is rested on the carton, trigger is squeezed for a strong carton, fastening from the outside
- Full cycle action for maximum speed, quick release to prevent jams and an adjustment for tightness and depth of clinch

Applications:

- Top closing virtually all types of corrugated containers where speed and maneuverability are a must
- Ideal for replacing or enhancing glue systems where added reliability and security are a must

Tool Description:

- Tool Weight: 5.56 lbs.
- Coil of 1000/load

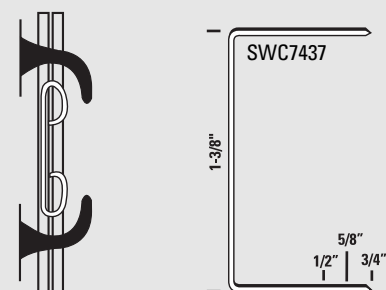

REFER TO 1-3/8" WIDE CROWN COIL PACKAGING STAPLE ON PAGE 51

D61ADCSB

Hand-Free Closure

Features:

- Same as D61ADC but bench mounted with large 4000 staple coil
- Carton contact activated trip allows operator to use both hands to maneuver carton for side strike stapling
- Ideal for replacing or enhancing glue systems where added reliability and security are a must

Applications:

- Hand-free small to medium box closure
- Ideal for overlap cartons and five-panel folders
- Ideal for replacing or enhancing glue systems where added reliability and security are a must

Tool Description:

- Tool Weight: 28 lbs.
- Coil of 4000

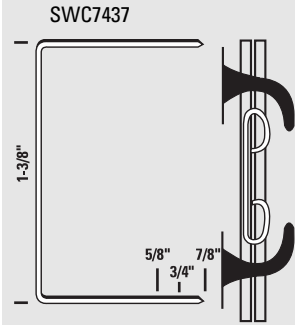

REFER TO 1-3/8" WIDE CROWN COIL SERIES ON PAGE 51

ESD-450S2P

6 Layer Clinching

Features:

- Pliers compresses corrugate drives and clinches staple with single trigger actuation
- Innovative power control valve, easily adjust power by 30%

Applications:

- Applications requiring clinching of more than 6 layers of cardboard such as end caps or spacers

Tool Description:

- Tool Weight: 8.5 lbs.
- Magazine Capacity: 160 staples
- Throat 8 deep x 1-1/2 high
- Walking stick option available
- 1/2 to 2 inch leg

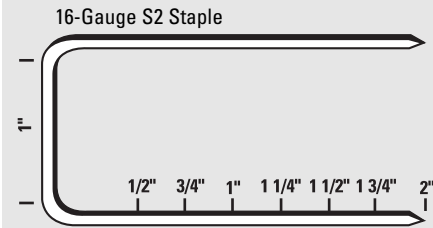

Available in: Coated

REFER TO 16 S2 SECTION ON PAGE 50

P50-10B, P50-5B

Carton Closing

Features:

- Powerful shuttle blade provides pre-compression squeezes material prior and during the driving and clinching operation, giving a strong tight closure without breaking the corrugated surface
- 6 inch by 1 inch high throat allows flexibility of staple placement and limits interference from obstacles such as box flanges

Applications:

- Fastening corrugated containers, vegetable tray boxes, end caps, pallet boxes, container inserts, die cut inserts, etc.
- Stapling of fabric

Tool Description:

- Tool Weight: 4.5 lbs.
- P50-10B Magazine Capacity: 102
- P50-5B Magazine Capacity: 168
- Penetrates and securely fastens up to two thicknesses of double wall AB flute 500 lb. test board or four thicknesses of single wall C flute 275 lb. test board (for more layers see ESD-450S2P)
- Kits available: P50K1 kit with foot valve, remote trigger valve and clincher; P50181 remote trigger valve; P50152A mattress clincher



For P50-5B

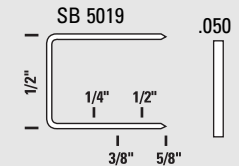

For P50-10B

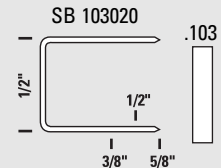

REFER TO SB5019 AND SB103020 SERIES ON PAGE 51

450S2

Corrugated to Wood

Features:

- Lightweight durable aluminum frame
- Jam-Free magazine
- Power control valve, adjusts power by 30%
- Long-lasting molded rubber comfort grip
- Reduced height for stapling in tight areas
- Rear exhaust directs exhaust away from user and work surface
- High capacity top-load magazine decreases reload time

Applications:

- Attaching corrugate to wood frame
- Wooden support and crate assembly

Tool Description:

- Tool Weight: 4.6 lbs.
- Driving Power: 240 inch lbs.
- Magazine Capacity: 160
- 1/2 to 2 inch leg

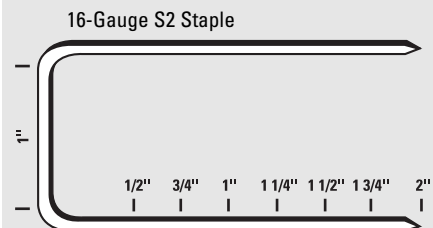

Available in: Coated

REFER TO 16 S2 SECTION ON PAGE 50

- ESD-450S2-WS 450S2 with 22-1/2" extended handle available for easy fastening of boxes to pallets



P6C-8F

Paper, Cloth Bag Sealer

Features:

- Twist neck of bag, hook over forked blade and squeeze pliers, staple wraps for a tight bag closure

Applications:

- Portable low-cost poly, paper or cloth bag sealing

Tool Description:

- Tool Weight: 1 lb.

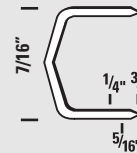

Bostitch® PowerCrown™ Staples
STCR5019 Series

REFER TO STCR 5019 SERIES ON PAGE 51



02245

Dry Cleaner and Florist Industry

Features:

- Rugged design for heavy use
- Top-load magazine

Applications:

- Dry cleaner and Florist industry

Tool Description:

- Tool Weight: 0.75 lbs.

7/16"

Bostitch® PowerCrown™ Staples



REFER TO STCR2115 SERIES ON PAGE 51



P7

Plastic, Cloth, or Mesh Bag Closure

Features:

- Spring-loaded magazine feed
- Also see RINGER9/16 on page 42

Applications:

- Closes off the neck of a twisted plastic, cloth or mesh bag

Tool Description:

- Tool Weight: 0.8 lbs.



Available in: Galvanized, stainless

REFER TO #7 ON PAGES 54 & 55



HFP9

Large Bag Closure

Features:

- 1-3/16 inch opening
- Spring-loaded magazine feed allows collated hog rings to feed directly into jaws
- Magazine pivots so it won't interfere with bag body

Applications:

- Wide opening for thick material or large bag closure

Tool Description:

- Tool Weight: 1.0 lbs.

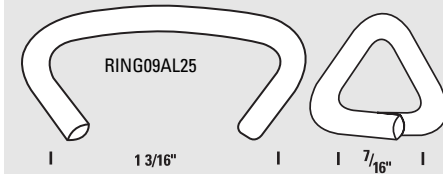

Available in: Aluminum

REFER TO #8 ON PAGES 54 & 55



SC760, SC761, SC743, SC7, SC7C, S760

Small to Medium Bag Closure

Features:

- SC743 set up with a zero balancer and manifold kit on a production line is ideal for applications where the bag is too heavy to easily lift
- Balancer BAL5N and manifold kit (SK014) (see picture page 25)
- MTCKA7 touch trip, bag guide mounting kit available (shown page 33)
- Also see SC73462, page 50 for 1/16" bag closure

Applications: SC760, SC761

- Small/medium bag closure

- Medium/large bag closure: concrete/powder, etc. bag liner closure

Tool Description: SC760, SC761:

- Tool Weight: 2.8 lbs.
- Magazine Capacity: 145
- **SC743, SC7, SC7C**
- Tool Weight: 2.8 lbs.
- Magazine Capacity: 125 rings

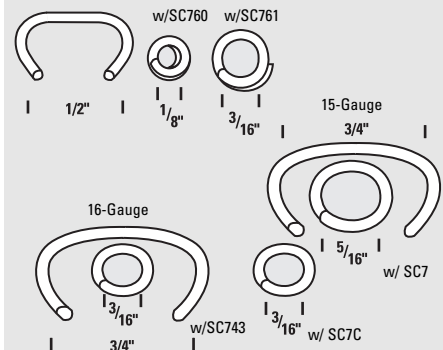

Available in: Galvanized, aluminum, stainless

SEE ADDITIONAL RINGS PAGE 54



SC50T

Very Large Bag Closure

Features:

- Air driven
- Large 1-1/2 opening
- MTCKA3 touch trip, bag guide kit
- MTCKA50 foot valve, bag guide kit

Applications:

- Very Large bag closure

Tool Description:

- Tool Weight: 14.3 lbs.
- Magazine Capacity: 125 rings

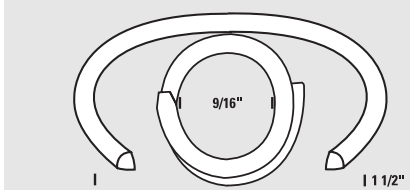

Available in: Galvanized, aluminum, stainless

REFER TO #9 ON PAGES 54 & 55

See page 42 for SC50HP (low-volume, hand plier version)

DO YOU HAVE A SPECIAL FASTENING NEED? WE HAVE YOU COVERED FROM A TO Z.

Every Specialty Fastening Job is different, but we can evaluate a sample of your application and recommend the Bostitch® fastener that best fits your needs.

A: Automotive seating cover secured to frame with a 15-gauge C-ring. Back assembly fastened with clinch clip.

B: Automotive control cables, brackets secured with C-rings.

C: Concrete pipe reinforcement wire secured with CL-38 clinch clips (see application chart on page 40).

D: Pre-cast concrete welded wire formsecured with 11-gauge C-rings.

E: HR-65C securing reinforcement wire prior to concrete pour.

F: Dog leash: Loop and catch assembly formed with clinch clip.

G: Large diameter rope loop secured with 11-gauge C-ring.

H: Bungee cord end can be secured with a 11, 14, 15 or 16-gauge C-ring.

I: Coated and non-coated wire secured with a SC73462 tool and a 16-gauge aluminum C-ring.

J: Cargo netting to rope can be connected with a 11, 14, 15 or 16-gauge C-ring.

K: Garland can be secured with an 11 or 15-gauge aluminum C-ring.

L: P7 tightening up a burlap root ball.

M: P7 permanently attaching a label to a potted container.

N: Rubber tree support secured with two 11-gauge C-rings.

O: SC743 tightening a root ball with a 16-gauge C-ring.

P: HR-86C-100 lightweight clip tool shown forming up sides of a lobster pot.

Q: SC742 short magazine tool attaching pot head to cage frame.

R: Bait bag secured with 15-gauge stainless steel C-ring.

S: Square blade of the HR-85C-100 clip tool producing a well-rounded cage hinge.

T: Cage grid secured with a blunt 15-gauge C-ring.

U: Machine mounted 750S4 Stapler equipped with remote TVA-4 trigger valves.

V: Rolled concertina wire clipped with HR-61.

W: Barbed tape loop formed with 11-gauge C-ring.

X: Oil absorption socks can be secured with 11-, 14-, 15- or 16-gauge blunt C-rings.

Y: Heat and sound insulation stitched with 16-gauge stainless steel C-rings.

Z: PN100 impact nailer used to secure gang box or drive any type of nail in tight spaces

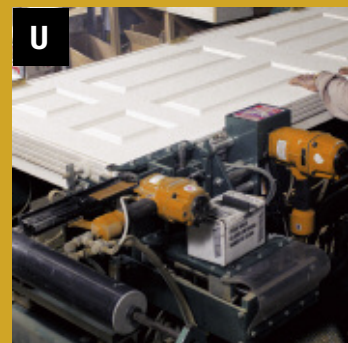
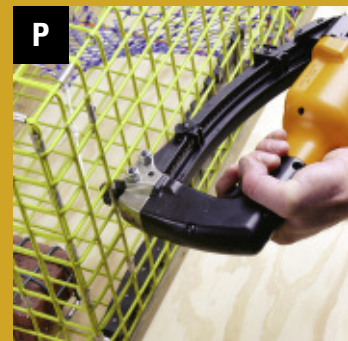
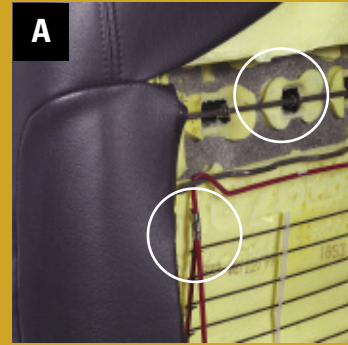

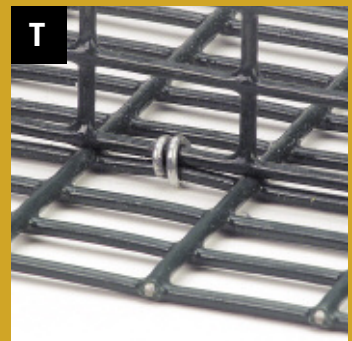
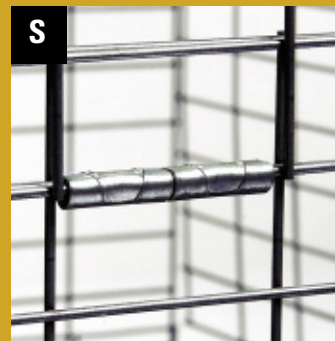
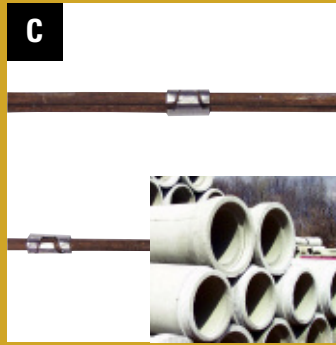
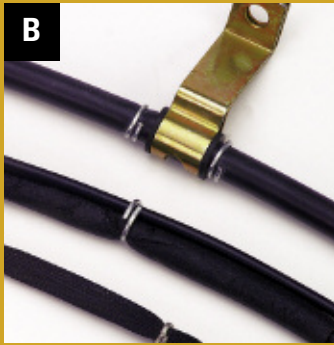

AUTOMOTIVE

We provide a wide range of tools for auto seat, upholstery and control cable applications



A. Ring Tools for automotive upholstery small control cables (see photos A, B, pages 40 & 41 and ring selection guide pages 54 & 55)

- SC7:** Standard C-ring tool for most seat applications
- SC7C:** For applications where tight closure of ring is needed
- SC7E:** Extended nose for hard-to-reach applications
- SC77XE:** Maximum nose length for deep trenches and bolsters

B. Features:

- 21671B:** Very lightweight, rugged, all metal construction, quiet, low air consumption
- 21671B-LM:** Same as 21671B but with long magazine; cuts reloading time
- 21671B-LN:** Same as 21671B but with extended nose for greater visibility and access to hard-to-reach areas, long nose also helps prevent scarring and scratching of wood.
- 21671B-A:** 2-function trigger: light squeeze for single fire mode; full squeeze for auto fire mode. Auto fire rate can be adjusted from 0 to 1600 staples/minute. Same hand that activates trigger also opens magazine allowing for new staple insertion with the free hand.
- 21671B-ALM:** Same as 21671B-A but w/long magazine (392 Staples) 21680B, 21680B-LN (long nose): Same as 21671B but fires 80 series staples

CONCRETE PIPE AND PRE-CAST CONCRETE WELDED WIRE REINFORCEMENT

Clinch Clips and Steel rings provide a faster low-cost alternative to welding of rolled wire mesh pipe reinforcement grids as well as forming of other NON-STRUCTURAL pre-cast pieces prior to casting.



A. Clip Tools for Welded Wire Reinforcement (see photo C, page 41)

- HR-66B, HR-65BAH:** Used to clip smaller gauge overlap seams
- HR-85SB:** Used to clip medium gauge overlap seams
- HR-88B:** Used to clip medium/large overlap seams

B. Ring Tools for Welded Wire Reinforcement (see photo D, page 41, see page 54 and 55 for Ring Selection)

- SC50T:** Pneumatic large ring tool used with 11-gauge rings to join larger diameter reinforcement wire
- SC50HP:** Same as above for low-volume use and repairs

TOOL APPLICATIONS	
CLIP	CLIPPING TOOL
HR-CLP-4	HR-66C-110
HR-CLP-24	HR-65C-130
HR-CLP-34	HR-85C-110
HR-CL-36T	HR-86C-100
HR-CL-38T	HR-88B

CLIP APPLICATIONS FOR REINFORCED CONCRETE PIPE			
WELDED WIRE "W" SIZE NUMBER	WELDED WIRE NOMINAL DIAMETER IN.	RECOMMENDED CLIP	RECOMMEND CLIP w/ 1/8" GAP BETWEEN GRID WIRES
W1.4	0.135"	HR-CLP-4	HR-CLP-24
W2	0.148"	HR-CLP-24	HR-CLP-24
W2	0.159"	HR-CLP-24	HR-CLP-34
W2.5	0.162"	HR-CLP-24	HR-CLP-34
W2.5	0.177"	HR-CLP-34	HR-CL-36T
W2.9	0.192"	HR-CL-36T	HR-CL-36T
W3.5	0.207"	HR-CL-36T	HR-CL-38T
W4.5	0.241"	HR-CL-38T	HR-CL-38T
W5	0.25"	HR-CL-38T	N/A

CAGE & TRAP ASSEMBLY

We can provide wire joining and hinge solutions for most cage and trap applications



A. Clip Tools for Cages. See clinch clip selection chart, page 45 for clip selection assistance. (Use tape collated clips for best results if cage is going through a post clipping plating process.)

HR-45: For small gauge wire. (10-14 gauge). Tool forms clip into a round tube for hinge applications as well as gives tight uniform appearance on fixed wire to wire fastening.

HR-45TN: Tool has thin and narrow anvil, provides clipping access for small gauge wire on tight grids (i.e. 1/2 in. x 1/2 in.)

HR-85C-100: For medium gauge wire (i.e. 7-, 8-, 9-gauge). Tool forms rounded tube for hinge applications.

HR-86C-100: For larger gauge wire (i.e. 6 to 6 gauge). Tool forms tube for hinge applications.

HR Clip Tool

Clip Tools for Traps Pots: Pinned side plates/nose won't get caught on grids (see photo P, page 40 and clipping chart and clip information pages 45, 52, and 53 for proper clip selection)

HR-86C-110: For applying clips to large grids

HR-86C-170: For applying 7/8 clips to 1" high x > 1" wide grids

HR-86C-170: For applying 3/4" clips to 1" wide x 1" high grids

B. Ring Tools for Trap / Pot Heads (Netting) to Frame

SC742 C-ring tool has short magazine for easy movement inside confined areas (see photo Q, page 41 and ring selection guide pages 54 and 55)

SC742: 16 gauge 3/16" ring closure for 3/4" x 3/4" wide grid.

SC760: 16 gauge 1/8" ring closure for 1/2" x 1/2" wide grid.

C. RINGER9/16: For repair of traps, pot heads and escape vents (see ring selection guide pages 54 and 55)

D. N58C-1: Coil Nailer for applying stainless steel nails to pot runners (see page 10 for tool details)

FENCING

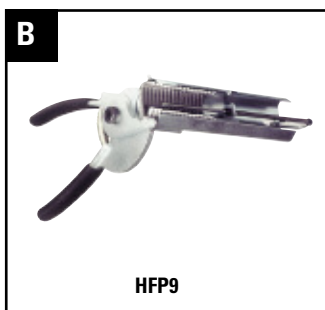

A. HR-61: This clip tool combined with galvanized clip HR-CL-61G (see photo V, page 41) to secure loops of barbed concertina wire. Tool and clip have detent for slip-resistance. Clip info page 52.

B. HFP9: Fencing plier is used to attach tension wire to bottom of fences, connect fence 'butt ends' attach signs, etc. (see photo, page 11) Tool Weight: 1.3 lbs., Magazine Capacity: 27 rings

C. SC50T: For securing coiled razor wire using C-rings (see photo W on page 41 for application) See page 37 for tool specs.

D. SC50HP: Hand Plier for low-volume and field connections of razor wire loops (RING11AL40, RING11RG40 only). Tool Weight: 9.7 lbs., Magazine Capacity: 42 rings

NURSERY / LANDSCAPING

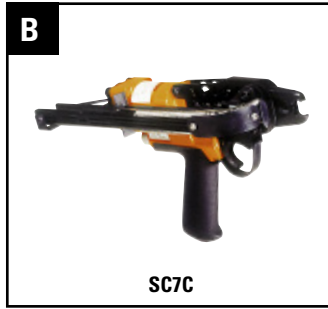
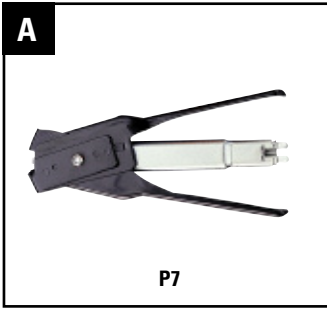

A. P7: Low cost method for tightening burlap root ball after tie-up. Provides secure method to permanently affix tags to potted plants. (see photo L, page 41, tool specs page 39)

B. SC7C: High-volume method for tightening burlap after tie-up; also used for silt fence applications (see photo O, page 41 for application, tool specs page 39)



C. RINGER9/16: For pot tagging and arrangements.

D. SC50HP: Used for loop-forming on rubber tree supports (see photo N, page 41). Also useful for large wreaths, garland to wire fastening (see photo K, page 41), and irrigation strain wire to hose. Tool Weight: 9.7 lbs., Magazine Capacity: 42 Rings

HEAT AND SOUND INSULATION



The SC7, SC743 and SC761, coupled with our sharp points and 16-gauge Stainless Steel C Ring, make short, efficient work out of stitching together tough insulation fabrics. (See photo Y, page 39 for application, and Ring Selection Guide on pages 54, 55.) See page 39 for tool specs.

LOOP FORMING: Rope, Bungee, Wire / Netting



Our clips and hog rings make excellent quick knot replacements for low and medium force applications.

We encourage sending in samples for factory recommendations. See application photos, F, G, H, I, J, N (pages 40 and 41 for examples refer to pages 54 and 55 for specific ring sizes.

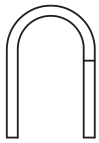
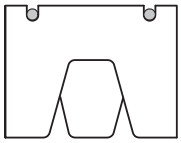

STRAIGHT to COIL SPRING APPLICATION CHART

Washburn & Moen (W & M)
Wire Gauge Chart

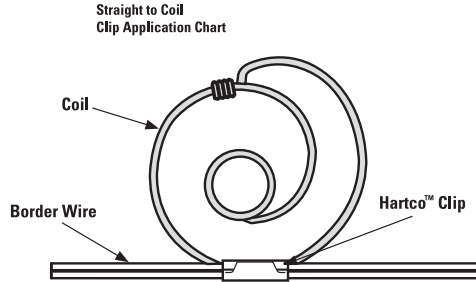

See pages 52 & 53 for Coil Clip & Tool Part Numbers

										WIRE GAUGE (DIA. IN.)
	19,2312	19,2312	19,2312	26,2312	26,2312	26,2312	26,2312	26,2312	26,2312	9 (.148)
	19,2312	19,2312	26,2312	26,2312	26,2312	26,312	26,312	26,312	26,312	8 (.162)
	33,312	33,312	33,312	33,312	33,312	32,412	32,4	32,4	32,4	6 (.192)
	32,4	32,4	32,4	32,4	4	4	4	4	4	5 (.207)
COIL GAUGE (DIA. IN.)	16.5 (.058)	16 (.062)	15.5 (.067)	15 (.072)	14.5 (.076)	14 (.080)	13.5 (.086)	13 (.091)	12.5 (.098)	INCH

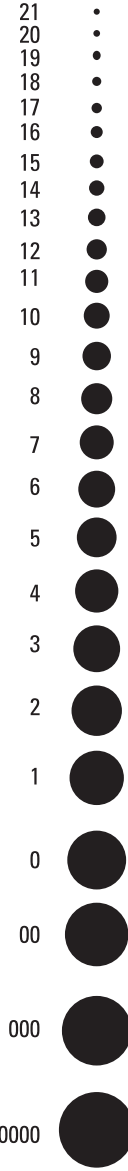

STRAIGHT to STRAIGHT WIRE APPLICATION CHART

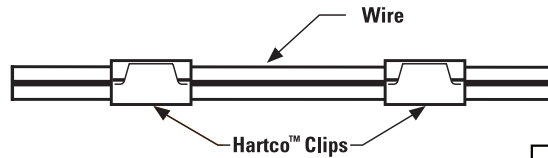

See pages 52 & 53 for
Clip & Tool Part Numbers

										Wire Gauge (Dia. In.)
								15	15	14 (.080)
							15	15	15	13 (.092)
						23,13	13,15	15	15	12 (.105)
					3,312,13	23,2312,3 312,13	23,2312	13,15	13	11 (.120)
				4	4	4	3,312	3,312	13	10 (.135)
			4	4	4	4	3,312	29	23,2312	9 (.148)
		36,34	4	4	4	4	4	4	3,312	8 (.162)
	36	36,34	34	34	4,34	4	4	4	29	7 (.177)
Wire Gauge (Dia. In.)	6 (.192)	7 (.177)	8 (.162)	9 (.148)	10 (.135)	11 (.120)	12 (.105)	13 (.092)	14 (.080)	INCH

SINUOUS SPRING to COVERED WIRE APPLICATION CHART

See page 52 & 53 Regular & Cushion Clip Section for Clip & Tool Part Numbers

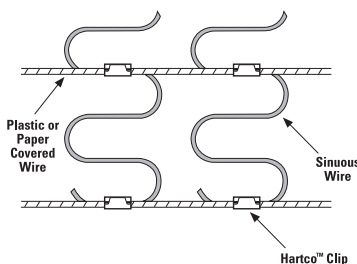

						TIE WIRE GAUGE (INNER CORE)
	3, 312	3, 312	3, 312	3, 312	3, 312	16 (.156)
	4	4	4	4	4	12 (.156)
SPRING GAUGE (DIA. IN.)	12 (.106)	11 (.121)	10 (.135)	9 (.148)	8 (.162)	INCH

Nail - Tool Selection Guide



Smooth Ring Screw

Nail Collation: Nails are collated using wire weld, plastic, tape or glue and are available in coil or stick format

Nail Shank: There are four types of nail shanks: **smooth** good withdrawal capacity, **ring** increased withdrawal capacity in soft woods, **screw** increased withdrawal capacity in hard woods, and **spiral** increases withdrawal capacity and driving power in hardwoods.

Nail Point: There are four basic point styles from which to choose:

(DP) Diamond Point: General purpose, best holding power

(BDP, BD) Blunt Diamond Point: Effective at reducing wood splitting and increasing driving power in hardwood applications

(CP) Chisel Point: The preferred point for trim applications

(BCP, BC) Blunt Chisel Point: Effective at reducing wood splitting in hardwood applications

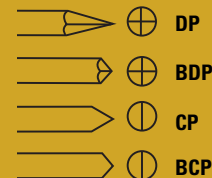

Pack Quantity = Fasteners Per Pack

Case Quantity = Packs Per Case

Skid Quantity = Cases Per Skid

Item Number	Item Description	Pack/Case/Skid	Application Tools
AC SERIES - ANGLED COIL NAILS			
AC2DR080BDP	.080"x1", RING, BDP	14000, 1, 42	N57C, N58C, N64084, N64C, N66C
AC3D080BDP	.080"x1-1/4", PLAIN, BDP	14000, 1, 42	N57C, N58C, N64084, N64C, N66C
AC3DR080BDP	.080"x1-1/4", RING, BDP	14000, 1, 42	N57C, N58C, N64084, N64C, N66C
AC3DSP-14M	.080"x1-1/4", SPIRAL, BDP	14000, 1, 42	N57C, N58C, N64084, N64C, N66C
AC3DSPGAL-14M	.080"x1-1/4", SPIRAL, GAL, BDP	14000, 1, 30	N57C, N58C, N64084, N64C, N66C
AC4D080BDP	.080"x1-1/2", PLAIN, BDP	14000, 1, 30	N57C, N58C, N64084, N64C, N66C
AC4D113HM	.113"x1-1/2", HLX SC, HT, MGAL DP	7500, 1, 42	N70C, N71C, N75C, N80C
AC4DR080BDP	.080"x1-1/2", RING, BDP	14000, 1, 30	N57C, N58C, N64084, N64C, N66C
AC4DSP113	SPIRAL, .113"x1-1/2", T	12000, 1, 30	N70C, N71C, N80C
AC4DSP113-LH	SPIRAL, .113"x1-1/2", T	12000, 1, 30	N70C, N71C, N80C
AC5D080BDP	.080"x1-3/4", PLAIN, BDP	14000, 1, 30	N57C, N58C, N64084, N64C, N66C
AC5DR080BDP	.080"x1-3/4", RING, BDP	14000, 1, 30	N57C, N58C, N64084, N64C, N66C
AC5DSPGAL-14M	SPIRAL, 1-3/4", GAL	14000, 1, 30	N57C, N58C, N64084, N64C, N66C
AC6DSP083MG	SPIRAL, .083"x2", NL, MECC	12600, 1, 30	N57C, N58C, N64084, N64C, N66C
AC6D090BDP	.090"x2", PLAIN, BDP	12000, 1, 30	N57C, N64C
AC6DR090BDP	.090", RING, 2", BDP	7200, 1, 30	N70C, N71C, N75C, N80C, N86C, N89C
AC6DSP099GAL	SPIRAL, .099"x2", BD, GAL	7200, 1, 30	N70C, N71C, N80C, N86C, N100C
AC6DGAL	.113"x2", PLAIN, GAL, BDP	5000, 1, 54	N57C, N64, N70C, N80C, N86C, N100C
AC7DR099BCP	.099"x2-1/4", RING, BCP	9000, 1, 36	N70C, N80C, N86C, N100C
AC7DSP09972	.099"x2-1/4", SPIRAL, BDP	7200, 1, 30	N80C, N86C, N100C
AC7DSP099GAL	SPIRAL, .099"x2-1/4", BD, GAL	7200, 1, 30	N80C, N86C, N100C
AC7DH	.131", PLN, 2-1/4" DP HARD	4500, 1, 42	N80C, N86C, N100C
AC8DRSS	.090"x2-1/2", RING, SS, DP	3600, 1, 56	N64C
AC8DSP09972GAL	SPIRAL, .099"x2-1/2" BD	7200, 1, 30	N70C, N80C, N86C, N100C
AC8DSP09972	.099"x2-1/2", SPIRAL, BDP	7200, 1, 30	N70C, N80C, N86C, N100C
AC8DRBDP	.113"x2-1/2", PLN, BDP	5000, 1, 42	N70C, N80C, N86C, N100C
AC8DSP	SPIRAL, 2-1/2"	6000, 1, 30	N80C, N86C, N100C
AC8D131GAL	.131"x2-1/2", PLAIN, GAL	4500, 1, 42	N70C, N80C, N86C, N100C
AC8DS-HT	2-1/2" NLHEAT	6000, 1, 30	N70C, N71C, N80C, N86C, N89C, N100C, N400C
AC9DSP09972	SPIRAL, .099"x2-3/4", BD	7200, 1, 36	N80C, N86C, N100C
AC10DR	.120"x3", RING, BD	4500, 1, 42	N75C, N80C, N86C, N89C, N100C, N400C
AC10DSP-4.5M	SPIRAL, 3"	4500, 1, 45	N75C, N80C, N86C, N89C, N100C, N400C
AC12DR	.120"x3-1/4", RING, BDP	4500, 1, 36	N80C, N86C, N89C, N100C, N400C
AC12DS	.120"x3-1/4", SCREW, BDP	4500, 1, 36	N80C, N86C, N89C, N100C, N400C
AC12DS131BDP	.131"x3-1/4", SCREW, BDP	4500, 1, 36	N80C, N86C, N89C, N100C, N400C
AC12DSPGAL	SPIRAL, GAL	4500, 1, 30	N80C, N86C, N100C

Item Number	Item Description	Pack/Case/Skid	Application Tools
ACL SERIES - LARGE ANGLED COIL NAILS			
ACL3DWG099BD-PP NAIL, ACL, .099", WEDGERIP, 1-1/4"		12000, 1, 26	Auto Mac. Mnted N70C
ACL4D099BD-OD	NAIL, COL, .099", PLN, 1-1/2", CLINCH POINT	11400, 1, 24	Auto Mac. Mnted N58C, N64C
ACL5D099BC-PP	A. COIL, .099"x1-3/4", SCRWB, BCP, LG	9000, 1, 24	Auto Mac Mnted N70C, N71C
ACL6D099BC-PP	A. COIL, .099"x2", SCRWB, BCP, LG	9000, 1, 24	Auto Mac Mnted N70C, N71C, N80C
ACL6D099BD-PP	A. COIL, .099"x2", SCRWB, BDP, LG	9000, 1, 24	Auto Mac Mnted N70C, N71C, N80C
ACL7D099BC-PP	A. COIL, .099"x2-1/4", SCRWB, BCP, LG	9000, 1, 24	Auto Mac Mnted N70C, N71C, N80C
ACL7D099BD-PP	A. COIL, .099"x2-1/4", SCRWB, BDP, LG	9000, 1, 24	Auto Mac Mnted N70C, N71C, N80C
ACL8D099BD-PP	A. COIL, .099"x2-1/2", SCRWB, BDP, LG	9000, 1, 24	Auto Mac Mnted N70C, N71C, N80C
ACL10DR120BDP	NAIL, COL, .120", LG, RING, 3"	5000, 1, 24	Auto Mac Mnted N80C, N400C
ACL10D131DP	A. COIL, .131"x3", PLN, DP, LG	4600, 1, 24	Auto Mac Mnted N80C, N400C
ACL12D131DP	A. COIL, .131"x3-1/4", PLN, DP, LG	4000, 1, 24	Auto Mac Mnted N80C, N400C
ACL12DS148DP	COIL, .148"x3-1/4", SCRWB, DP, LG	4000, 1, 24	Auto Mac Mnted N80C, N400C
ACL16D162BDP	LG COIL, 3-1/2"x162", SM, BDP	2250, 1, 48	Auto Mac Mnted N400C, N130C
ACL16D162BDPG	LG CL, 3-1/2"x162", SM, BDP, GA	2250, 1, 48	Auto Mac Mnted N400C, N130C
ACP SERIES - PLASTIC COLLATED SIDING NAILS			
ACP5DSALM	A. COIL, .099" x 1-3/4", SCREW, ALUM, DP	2400, 1, 108	N64C w/conv. Kit, N66C
ACP6D090BDG	NAIL, COL, .090", PLN, 2", GA	3600, 1, 32	N64C w/conv. Kit, N66C
ACP6DCRALM10M	A. COIL, .099"x1-7/8", RING, ALUM, DP	10000, 1, 16	N64C w/conv. Kit, N66C
ACP6DSALM	A. COIL, .099"x2", SCREW, ALUM, DP	2400, 1, 99	N64C w/conv. Kit, N66C
ACP7D090BDG	NAIL, COL, .090", PLN, 2.25", GAL	3600, 1, 27	N64C w/conv. Kit, N66C
ACP7DR090BDG	NAIL, COL, .090", RING, 2.25", GAL	3600, 1, 27	N64C w/conv. Kit, N66C
ACP8DR090BDSS	NAIL, COL, .090", RING, 2.5", SS	3600, 1, 27	N64C w/conv. Kit, N66C
ACP8D090BDG	NAIL, COL, .090", PLN, 2.5", GAL	3600, 1, 27	N64C w/conv. Kit, N66C
BULK PALLET NAILS			
B158DS105NP-PP	1-5/8" x .105" SCRWB, NP, BULK PP NAIL	-11170, 1, 48	
B6DS105BD-PP	2" x .105" SCRWB, BD, BULK PP NAIL	-9275, 1, 48	
B7DS105BD-PP	2-1/4" x .105" SCRWB, BD BULK PP NAIL	-8330, 1, 48	

Item Number	Item Description	Pack/Case/Skid	Application Tools
BT SERIES - 18-GAUGE CHISEL POINT BRADS (5/8" to 2")			
BT1300-5M BT1300B	BRAD, 18GA, 5/8", 15MM, PLAIN BRAD, 18GA, 5/8", 15MM, BROWN	5000, 20, 960 3000, 10, 2750	BT35B, BT125, BT200 BT35B, BT125, BT200
BT1303-5M BT1303B BT1303-0592	BRAD, 18GA, 3/4", 19MM PLAIN BRAD, 18GA, 3/4", 19MM, BROWN BRAD 3/4" LBROWN	5000 3000, 10, 2250 3000, 10, 1960	BT35B, BT125, BT200 BT35B, BT125, BT200 BT35B, BT125, BT200
BT1309-5M BT1309B BT1309-0400 BT1309-0592	BRAD, 18GA, 1", 25MM, PLAIN BRAD, 18GA, 1", 25MM BROWN BRAD, 18GA, 1", 25MM, WHITE BRAD, 18GA, 1", 25MM, LBROWN	5000 3000, 10, 1750 3000, 10, 1440 3000, 10, 1440	BT35B, BT125, BT200 BT35B, BT125, BT200 BT35B, BT125, BT200 BT35B, BT125, BT200
BT1314 BT1314-0400 BT1314-0592 BT1314-7120 BT1314-7130 BT1314B BT1314B-9011B	BRAD, 18GA, 1-3/16", 30MM, PLN BRAD 1-3/16" WHITE BRAD 1-3/16" LBROWN BRAD 1-3/16" LIGHT BROWN BRAD 1-3/16", HONEY OAK BRAD 1-3/16", 30MM BROWN BRAD 1-3/16, 30MM, BLUEWD	3000, 10, 130 3000, 10, 1260 3000, 10, 1260 3000, 10, 1260 3000, 10, 1260 3000, 10, 130 3000, 10, 130	BT35B, BT125, BT200 BT35B, BT125, BT200 BT35B, BT125, BT200 BT35B, BT125, BT200 BT35B, BT125, BT200 BT35B, BT125, BT200 BT35B, BT125, BT200
BT1332-5M BT1332B BT1332-0400	BRAD, 18GA, 1-1/4", PLN 1-1/4" 18 GAUGE BRAD BROWN 1-1/4" 18 GAUGE BRAD WHITE	5000 3000, 10, 1300 3000, 10, 1300	BT35B, BT125, BT200 BT35B, BT125, BT200 BT35B, BT125, BT200
BT1335 BT1335B	BRAD, 18GA, 1-3/8", 34MM, PLN BRAD, 18GA, 1-3/8", 34MM BROWN	3000, 10, 840 3000, 10, 840	BT35B, BT50B, BT200 BT35B, BT50B, BT200
BT1338-5M BT1338B BT1338-0400 BT1338-0592	1-1/2" 18 GAUGE BRAD, PLAIN 1-1/2" 18 GAUGE BRAD, BROWN BRAD 1-1/2" WHITE BRAD 1-1/2" LBROWN	5000 2000, 10, 1540 2000, 10, 1540 2000, 10, 1540	BT200 BT200 BT200 BT200
BT1340 BT1345-5M BT1345B BT1345-0400 BT1345-7120	BRAD, 18GA, 1-9/16", 39MM, PLN BRAD, 18GA, 1-3/4", 44MM, PLN BRAD, 18GA, 1-3/4", 44MM BWN BRAD 1-3/4" WHITE BRAD 1-3/4" LIGHT BROWN	2000, 10, 1540 5000 2000, 10, 1360 2000, 10, 1260 2000, 10, 1260	BT50B, BT200 BT50B, BT200 BT50B, BT200 BT50B, BT200 BT50B, BT200
BT1350-5M BT1350-0400 BT1350-0592 BT1350B	BRAD, 18GA, 2" PLAIN BRAD 2" WHITE BRAD 2" LBROWN BRAD, 18GA, 2", 50MM, BROWN	5000 2000, 10, 1260 2000, 10, 1260 2000, 10, 119	BT50B, BT200 BT50B, BT200 BT50B, BT200 BT50B, BT200
C SERIES - 15° DEGREE COIL FRAMING NAILS			
C2S100DGHT C3R80BDG C3R90BDSS	COIL, .100"x1", SCREW, DP, GAL COIL, .080"x1-1/4", RING, BDP, GAL COIL, .090"x1-1/4", RING, BDP, SS	2700, 1, 32 4200, 1, 80 3600, 1, 80	N57C, N58C, N64C N57C, N58C, N64C N57C, N58C, N64C
C4R80BDG C4R90BDSS C4PSTIF C4DCSBALG	COIL, .080"x1-1/2", RING, BDP, GAL COIL, .090"x1-1/2", RING, BDP, SS COIL, .099"x1-1/2", PLN, SS COIL, .100"x1-3/8", BALISTIC, GAL	4200, 1, 80 3600, 1, 80 3600, 1, 80 3600, 1, 64	N57C, N58C, N64C, N64084, N66C N57C, N58C, N64C, N64084, N66C N64C, N64099, N66C, N80CB, N89C N57C, N58C, N64C, N64084, N66C
C5R80BDG C5R90BDSS	COIL, .080"x1-3/4", RING, BDP, GAL COIL, .090"x1-3/4", RING, BDP, SS	4200, 1, 64 3600, 1, 64	N57C, N58C, N64C, N64084, N66C N57C, N58C, N64C, N64084, N66C
C6R90BDG C6R90BDSS	COIL, .090"x2", RING, BDP, GAL COIL, .090"x2", RING, BDP, SS	3600, 1, 64 3600, 1, 64	N57C, N58C, N64C, N64084, N66C, N70C, N71C N57C, N58C, N64C, N64084, N66C, N70, N71
C6P90BDG	COIL, .090"x2", PLN, BDP, GAL	3600, 1, 64	N57C, N58C, N64C, N64084, N66C, N70, N71
C6P99D C6P99DG C6R99BC C6R99BCG C7PSTIF C7P90BDG C7R90BDG C7R90BDG-0400	COIL, .099"x2", PLN, DP COIL, .099"x2", PLN, DP, GAL COIL, .099"x2", RING, BCP COIL, .099"x2", RING, BCP, GAL COIL, .099"x2-1/4", PLN, SS COIL, .090"x2-1/4", PLN, BDP, GAL COIL, .090"x2-1/4", RING, BDP, GAL COIL, .090"x2-1/4", RING, BDP, GAL, WHITE	3600, 1, 64 3600, 1, 64 3600, 1, 64 3600, 1, 64 3600, 1, 64 3600, 1, 56 3600, 1, 56 3600, 1, 56	N64099, N70C, N71C, N80C N64099, N70C, N71C, N80C N64099, N70C, N71C, N80C N64099, N70C, N71C, N80C, N89C N57C, N58C, N64C, N64084, N66C N57C, N58C, N64C, N64084, N66C N57C, N58C, N64C, N64084, N66C
C7R90BDSS C7R90BDSS-7120	COIL, .090"x2-1/4", RING, BDP, SS COIL, .090"x2-1/4", RING, BDP, SS, LBROWN	3600, 1, 56 3600, 1, 56	N57C, N58C, N64C, N64084, N66C N57C, N58C, N64C, N64084, N66C
C7R99BCG C10P148D-SHORT	COIL, .099"x2-1/2", RING, BCP, GAL COIL, .148"x2-1/4", PLN, DP	3600, 1, 56 2700, 1, 48	N57C, N58C, N64C, N64099 N80C, N86C, N100C, N100CPP
C8P90BDG C8R90BDG C8P99D	COIL, .090"x2-1/2", PLN, BDP, GAL COIL, .090"x2-1/2", RING, BDP, GAL COIL, .099"x2-1/2", PLN, DP	3600, 1, 56 3600, 1, 56 3600, 1, 56	N64C, N64084, N66C, N75C N64C, N64084, N66C, N75C N70C, N71C, N75C, N80C, N86C,

Item Number	Item Description	Pack/Case/Skid	Application Tools
C SERIES - 15° DEGREE COIL FRAMING NAILS			
C8P99DG C8R99BCG C8R99BD C8R99BDSS C8P120D C8P131D C10R120DSS C10S120DG C10P120D C10P120DG C10P131D C12R120DSS C12S120DG C12P120D C12P120DG C12P131D C16P131D C16P131DG C20S120D C20P131D C20P131DG	COIL, .099"x2-1/2", PLN, DP, GAL COIL, .099"x2-1/2", RING, BCP, GAL COIL, .099"x2-1/2", RING, BDP COIL, .099"x2-1/2", RING, BDP, SS COIL, .120"x2-1/2", PLN, DP COIL, .131"x2-1/2", PLN, DP COIL, .120"x3", RING, DP, SS COIL, .120"x3", SCREW, DP, GAL COIL, .120"x3", PLN, DP COIL, .120"x3", PLN, DP, GAL COIL, .131"x3", PLN, DP COIL, .120"x3-1/4", RING, DP, SS NAIL, .120"x3-1/4", SCREW, DP, GAL COIL, .120"x3-1/4", PLN, DP COIL, .120"x3-1/4", PLN, DP, GAL COIL, .131"x3-1/4", PLN, DP COIL, .131"x3-1/2", PLN, DP COIL, .131"x3-1/2", PLN, DP, GAL COIL, .120"x4", SCREW, DP COIL, .131"x4", PLN, DP COIL, .131"x4", PLN, DP, GAL	3600, 1, 56 3600, 1, 56 3600, 1, 56 3600, 1, 56 2700, 1, 56 2700, 1, 56 2700, 1, 48 2700, 1, 48 2700, 1, 48 2700, 1, 48 2700, 1, 48 2700, 1, 40 2700, 1, 40 2700, 1, 40 2700, 1, 40 2700, 1, 40 2700, 1, 40 2700, 1, 32 2700, 1, 32 2700, 1, 32	N70C, N71C, N75C, N80C, N86C, N89C, N400C N70C, N71C, N75C, N80C, N86C, N89C, N400C N70C, N71C, N75C, N80C, N86C, N89C, N400C N70C, N71C, N75C, N80C, N86C, N89C, N400C N75C, N80C, N86C, N89C, N400C N75C, N80C, N86C, N89C, N400C N80C, N86C, N100C, N400C, N100CPP N80C, N86C, N100C, N400C, N100CPP N80C, N86C, N100C, N400C, N100CPP N80C, N86C, N100C, N400C, N100CPP N80C, N86C, N100C, N400C, N100CPP N80C, N86C, N100C, N100CPP N80C, N86C, N100C, N100CPP N80C, N86C, N100C, N100CPP N80C, N86C, N100C, N100CPP N100C, N100CPP, N130C N100C, N100CPP, N130C N100C, N100CPP, N130C N100C, N100CPP, N130C
CR SERIES - COLLATED ROOFING NAILS			
CR19GAL CR2DCGAL CR2DGAL CR3DGAL CR3DSS CR4DGAL CR4DSS CR5DGAL	COIL, ROOF, .120"x3/4", GAL COIL, ROOF, .120"x7/8", GAL COIL, ROOF, .120"x1", GAL NAIL, COL, .120", ROOF, 1-1/4", GAL COIL, ROOF, .120"x1-1/4", SS COIL, ROOF, .120"x1-1/2", GAL NAIL, COL, .120", ROOF, 1-1/2", SS COIL, ROOF, .120"x1-3/4", GAL	7200, 1, 64 7200, 1, 56 7200, 1, 56 7200, 1, 48 7200, 1, 48 7200, 1, 40 7200, 1, 36 7200, 1, 32	RN45B, RN46 RN45B, RN46 RN45B, RN46 RN45B, RN46 RN45B, RN46 RN45B, RN46 RN45B, RN46 RN45B, RN46
FC SERIES COIL NAILS - PALLET PLUS			
FC3DWG099BD-PP FC5DS084BD-PP FC5DS099BC-PP FC5DS099BD-PP FC6DS084BD-PP FC6DS099BC-PP FC6DS099BD-PP FC7DS084BD-PP FC7DS099BC-PP FC7DS099BD-PP FC8DS099BC-PP FC8DS099BD-PP	COIL, .099", WEDGEGRIP, 1-1/4" COIL, .084"x1-3/4", SCREW, BDP COIL, .099"x1-3/4", SCREW, BCP COIL, .099"x1-3/4", SCREW, BDP COIL, .084"x2", SCREW, BDP COIL, .099"x2", SCREW, BCP COIL, .099"x2", SCREW, BDP COIL, .084"x2-1/4", SCREW, BDP COIL, .099"x2-1/4", SCREW, BCP COIL, .099"x2-1/4", SCREW, BDP COIL, .099"x2-1/2", SCREW, BCP COIL, .099"x2-1/2", SCREW, BDP	9000, 1, 36 12000, 1, 24 12000, 1, 36 12000, 1, 36 9000, 1, 30 9000, 1, 42 9000, 1, 42 9000, 1, 24 9000, 1, 36 9000, 1, 36 6000, 1, 42 6000, 1, 42	N64099 (Deck Mat Nail) N57C, N58C, N64084 N64099, N70C, N71C, N80CB N64099, N70C, N71C, N80CB N57C, N58C, N64084 N64099, N70C, N71C, N80CB N64099, N70C, N71C, N80CB N57C, N58C, N64084 N64099, N70C, N71C, N80CB N64099, N70C, N71C, N80CB N64099, N70C, N71C, N80CB N64099, N70C, N71C, N80CB
FC SERIES COIL NAILS			
FC3D080-0D FC4D080-0D FC4DS080BD FC4DS099BC FC6DR099BD-FS FC6DS105BD FC6DS113BC	.080"x1-1/4", PLN, OFFSET DIA .080"x1-1/2", PLN, OFFSET DIA .080"x1-1/2", SCREW, BDP .099"x1-1/2", SCREW, BCP .099"x2", MOD RING, BDP FLR SHTHR .105"x2", SCREW, ANGLE, BDP .113"x2", SCREW, BCP	16800, 1, 42 16800, 1, 42 16800, 1, 36 14400, 1, 36 9000, 1, 30 9000, 1, 36 6000, 1, 48	N57C, N58C, N64084 N57C, N58C, N64084 N57C, N58C, N64084 N64099 N70C, N71C, N80CB N70C, N80CB, N86CB N70C, N80CB, N86CB

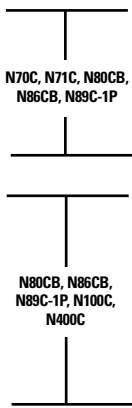

Item Number	Item Description	Pack/Case/Skid	Application Tools
FC SERIES COIL NAILS (Continued)			
FC7DS105BD	.105"x2-1/4", SCREW, BDP	6000, 1, 42	 <p>N70C, N71C, N80CB, N86CB, N89C-1P</p> <p>N80CB, N86CB, N89C-1P, N100C, N400C</p> <p>N89C-1P, N100C, N400C, N130C</p> <p>N100C, N400C, N130C</p>
FC7DS113BC	.113"x2-1/4", SCREW, BCP	6000, 1, 42	
FC8DS099NP	.099"x2-1/2", NO POINT	6000, 1, 36	
FC8DS113BC	.113"x2-1/2", SCREW, BCP	6000, 1, 42	
FC8DS120BD	.120"x2-1/2", SCREW, BDP	5400, 1, 42	
FC9DS113BD	.113"x2-3/4", SCREW, BDP	6000, 1, 36	
FC9DR120BDP	.120"x2-3/4", RING, BDP	5400, 1, 36	
FC10DS113BD	.113"x3", SCREW, BDP	6000, 1, 36	
FC10DS	.120"x3", SCREW, BDP	5400, 1, 36	
FC16DS131	.131"x3-1/2", SCREW, DP	2700, 1, 40	
FC20DS131	.131"x4", SCREW, DP	2700, 1, 32	

FN 15 SERIES - 15-GAUGE STICK COLLATED FINISH NAILS

FN1520	.072"x1-1/4", GAL	3655, 4, 80	 <p>N62FN</p>
FN1524	.072"x1-1/2", GAL	3655, 4, 80	
FN1524-7120	.072"x1-1/2" LIGHT BROWN	3655, 4, 80	
FN1524CCGAL	1-1/2", CROSS CUT, GAL	3500, 4, 60	
FN1524SS	.150"x1-1/2", STAINLESS ST	3655, 4, 85	
FN1528	.072"x1-3/4", GAL	3655, 4, 80	
FN1532	.072"x2", GAL	3655, 4, 68	
FN1532ALM	.072"x2", ALUM	3665, 4, 90	
FN1532CCGAL	.150"x2", CROSS CUT GAL	3500, 4, 60	
FN1532SS	.150"x2", GAL, STAINLESS ST	3655, 4, 68	
FN1536	.072"x2-1/4", GAL	3655, 4, 54	
FN1536CCGAL	.072"x2-1/4", CROSS CUT, GAL	3500, 4, 60	
FN1540	.072"x2-1/2", GAL	3655, 4, 54	
FN1540-0592	.072"x2-1/2", GAL, LIGHT BRWN	3655, 4, 54	
FN1540CCGAL	.072"x2-1/2", CROSS CUT GAL	3500, 4, 60	
FN1540SS	.072"x2-1/2", STAINLESS ST	3655, 4, 54	

FN 16 SERIES - 16-GAUGE STICK COLLATED FINISH NAILS

FN1616	STICK, FIN, .062"x1", GAL	5000, 4, 128	 <p>N52FN</p>
FN1620	STICK, FIN, .062"x1-1/4", GAL	5000, 4, 112	
FN1624	STICK, FIN, .062"x1-1/2", GAL	5000, 4, 80	
FN1628	STICK, FIN, .062"x1-3/4", GAL	5000, 4, 80	
FN1632	STICK, FIN, .062"x2", GAL	5000, 4, 64	
FN1632-0592	STICK, FIN, .062"x2", LBROWN	5000, 4, 64	

PT-MC SERIES- PAPER TAPE METAL CONNECTOR NAILS

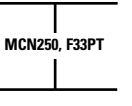
PT-MC13115-1M	1.5"x.131" PT MCN NAIL	1000, 4, 64	MCN150, F33PT
PT-MC13115GAL1M	1.5"x.131" PT MCN NAIL GAL	1000, 4, 64	MCN150, F33PT
PT-MC13125-1M	2.5"x.131" PT MCN NAIL	1000, 1, 140	MCN250, F33PT
PT-MC13125GAL1M	2.5"x.131" PT MCN NAIL GAL	1000, 1, 140	MCN250, F33PT
PT-MC14815-1M	1.5"x.148" PT MCN NAIL	1000, 4, 64	MCN150, F33PT
PT-MC14815GAL1M	1.5"x.148" PT MCN NAIL GAL	1000, 4, 64	MCN150, F33PT
PT-MC14825-1M	2.5"x.148" PT MCN NAIL	1000, 1, 144	 <p>MCN250, F33PT</p>
PT-MC14825GAL1M	2.5"x.148" PT MCN NAIL GAL	1000, 1, 144	
PT-MC16225-1M	2.5"x.162" PT MCN NAIL	1000, 1, 144	
PT-MC16225GAL1M	2.5"x.162" PT MCN NAIL GAL	1000, 1, 144	

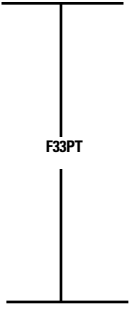
Item Number	Item Description	Pack/Case/Skid	Application Tools
PT SERIES- 33" PAPER TAPE FRAMING NAILS			
PT-S6D113EP	2"x.113" SMOOTH BRITE	5000, 1, 84	 <p>F33PT</p>
PT-S6DR113EP	2"x.113" RING	5000, 1, 84	
PT-S8D113EP	2-3/8"x.113" SMOOTH BRITE	5000, 1, 70	
PT-S8DR113EP	2-3/8"x.113" RING BRITE	5000, 1, 70	
PT-S8D113HDG	2-3/8"x.113" SMOOTH HDG	5000, 1, 70	
PT-S8DR113HDG	2-3/8"x.113" RING HDG	5000, 1, 70	
PT-S10D120EP	3"x.120" SMOOTH BRITE	3000, 1, 80	
PT-S10D131EP	3"x.131" SMOOTH BRITE	3000, 1, 70	
PT-S10DR120HDG	3"x.120" RING HDG	3000, 1, 80	
PT-S10D120HDG	3"x.120" SMOOTH HDG	3000, 1, 80	
PT-S12D131EP	3-1/4"x.131 SMOOTH BRITE	2500, 1, 72	
PT-S12D131HDG	3-1/4"x.131 SMOOTH HDG	2500, 1, 72	
PT-S16D131EP	3-1/2"x.131 SMOOTH BRITE	2500, 1, 72	
PT-S16D131HDG	3-1/2"x.131" SMOOTH HDG	2500, 1, 72	



RH-MC SERIES 21" ROUND HEAD METAL CONNECTOR NAILS



RH-MC13115-S	.131"x1-1/2", HEAT TREAT	1000, 1, 200	 <p>N88RH-2MCN, F21PL</p>
RH-MC13115GAL-S	.131"x1-1/2", GAL HEAT TREAT	1000, 1, 200	
RH-MC14815-S	.148"x1-1/2", HEAT TREAT	1000, 1, 200	
RH-MC14815GAL-S	.148"x1-1/2", GAL HEAT TREAT	1000, 1, 200	
RH-MC13125-S	.131"x2-1/2", HEAT TREAT	1100, 1, 140	
RH-MC13125GAL-S	.131"x2-1/2", GAL HEAT TREAT	1100, 1, 140	
RH-MC14825-S	.148"x2-1/2", HEAT TREAT	900, 1, 140	
RH-MC14825GAL-S	.148"x2-1/2", GAL HEAT TREAT	900, 1, 140	
RH-MC16225-S	.162"x2-1/2", HEAT TREAT	900, 1, 140	
RH-MC16225GAL-S	.162"x2-1/2", GAL HEAT TREAT	900, 1, 140	

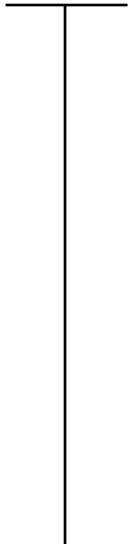

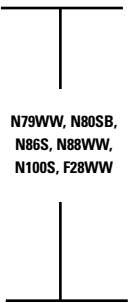
RH AND S SERIES - 21" PLASTIC COLLATED ROUND HEAD STICK FRAMING NAILS

RH-S6DEP	STK, .113", PLN, 2", EP	6000, 1, 56	 <p>N88RH, F21PL</p>
RH-S6DHDG	STK, RH, .113"x2", PLN	5000, 1, 48	
RH-S6DRHDG	2"x.113 SM HOT GALV	6000, 1, 56	
RH-S6DRHDG	2"x.113" RING HOT GALV	6000, 1, 56	
RH-S214DEP	2-1/4"x.148" SM BRITE	4000, 1, 56	
RH-S214DREP	2-1/4"x.148" RING BRITE	4000, 1, 56	
RH-S214DSEP	2-1/4"x.148" SCREW BRITE	4000, 1, 56	
RH-S8D113EP	STICK, RH, .113"x2-3/8", PLN	5000, 1, 48	
RH-S8DR113EP	STICK, RH, .113"x2-3/8", RING	5000, 1, 48	
RH-S8D113HDG	2-3/8"x.113" SM HDG	5000, 1, 56	
RH-S8DR113HDG	2-3/8"x.113" RING HOT GAL	5000, 1, 56	
RH-S8DR113SS	2-3/8"x.113" RING - STAINLESS	2500, 1, 48	
RH-S8D120EP	NAIL, STK, .120", PLN, 2-3/8", EP	5000, 1, 56	
RH-S8D148EP	2-3/8"x.148" SM BRITE	4000, 1, 42	
RH-S8DS148EP	2-3/8"x.148" SCREW - BRITE	4000, 1, 42	
RH-S8DR113-HQ	HURRIQUAKE™ NAIL 2-1/2"x.113" RING	5000, 1, 48	
RH-S8DR131-HQ	HURRIQUAKE™ NAIL 2-1/2"x.131" RING	4000, 1, 48	
RH-S8D131EP	STICK, RH, .131 x 2-1/2, PLN	5000, 1, 48	
RH-S8D131HDG	2-1/2"x.131" SM HT GALV	5000, 1, 48	
RH-S10D120EP	3"x.120" SM BRITE	4000, 1, 56	
RH-S10DR120SS	3"x.120" RING STAINLESS	2000, 1, 48	
RH-S10D131EP	STICK, RH, .131"x3", PLN	4000, 1, 48	
RH-S10DR131EP	3"x.131" RING BRITE	4000, 1, 56	
RH-S10D131HDG	3"x.131" SM HOT GALV	4000, 1, 42	
RH-S10D148EP	STICK, RH, .148"x3", PLN	3080, 1, 48	
RH-S12D120EP	3-1/4"x.120" SM BRITE	4000, 1, 42	
RH-S12D131EP	STICK, RH, .131"x3-1/4", PLN	4000, 1, 48	
RH-S12D131HDG	3-1/4"x.131" SM HOT GAL	4000, 1, 48	
RH-S12D148EP	NAIL, STK, .148", PLAIN, 3-1/4"	3000, 1, 48	
RH-S12DS148EP	3-1/4"x.148" SCR BRIGHT	3000, 1, 48	
RH-S12DS148HDG	3-1/4"x.148" SCREW HDG	3000, 1, 42	
RH-S16D131EP	STICK, RH, .131"x3-1/2", PLN	4000, 1, 48	
RH-S16D131HDG	3-1/2"x.131" SM HDG	4000, 1, 42	
RH-S16D135EP	STICK, RH, .135"x3-1/2", PLN	2000, 1, 48	
RH-S16D162EP	STICK, RH, .162"x3-1/2", PLN	3000, 1, 48	

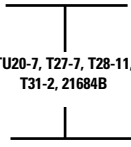
Item Number	Item Description	Pack/Case/Skid	Application Tools
RH AND S SERIES - 21° PLASTIC COLLATED ROUND HEAD STICK FRAMING NAILS			
S8DPLEX	STICK, .131"x2-1/2", SM, DUPLX	4500, 1, 45	RN90PLEX-1
S16DPLEX	STICK, .131"x3-1/2", SM, DUPLX	4000, 1, 45	RN90PLEX-1
S34S-115B	STICK, .134"x4-1/2", SCREW	1250, 1, 96	BIGBERTA160, KN85
S38-100B	STICK, .150"x4", PLN	1250, 1, 96	BIGBERTA160, KN85
S38-115B	STICK, .150"x4-1/2", PLN	1250, 1, 80	BIGBERTA160, KN85
S38-130B	STICK, .150"x5-1/8", PLN	1250, 1, 60	BIGBERTA160, KN85
S42-130B	STICK, .165"x5-1/8", PLN	1250, 1, 60	BIGBERTA160, KN85
S42-160B	STICK, .165"x6-1/4", PLN	500, 1, 76	BIGBERTA160, KN85
S SERIES - 28° WIRE COLLATED STICK FRAMING NAILS DP			
S6D-FH	STICK, WC, .113"x 2", PLN	2000, 1, 124	
S6DGAL-FH	STICK, WC, .113"x 2", PLN, GAL	2000, 1, 124	
S6DR113-FH	STICK, WC, .113"x 2", RING	2000, 1, 124	
S6DR113GAL-FH	STICK, WC, .113"x 2", RING, GAL	2000, 1, 124	
S8D131-FH	STICK, WC, .131"x 2-1/2", PLN	2000, 1, 92	
S8D131GAL	STICK, WC, .131"x 2-1/2", PLN, GAL	2000, 1, 90	
S8D-FH	STICK, WC, .120"x 2-3/8", PLN	2000, 1, 92	
S8DGAL-FH	STICK, WC, .120"x 2-3/8", PLN, GAL	2000, 1, 92	
S8DH	STICK, WC, .131"x 2-1/2", PLN, HT	2000, 1, 90	
S8DR	STICK, WC, .113"x 2-3/8", RING	2000, 1, 90	
S8DR-FH	STICK, WC, .120"x 2-3/8", RING	2000, 1, 92	
S8DRGAL-FH	STICK, WC, .120"x 2-3/8", RING, GAL	2000, 1, 92	
S8DRSS-1M	STICK, WC, .113"x 2-3/8", RING, SS	1000, 4, 75	
S8DS	STICK, WC, .113"x 2-3/8", SCREW	2000, 1, 90	
S8DSS-1M	STICK, WC, .113"x 2-3/8", PLN, SS	1000, 4, 75	
S10D131-FH	STICK, WC, .131"x 3", PLN	2000, 1, 88	<p>N79WW, N80SB, N86S, N88WW, N100S, F28WW</p>
S10D131GAL	STICK, WC, .131"x 3", PLN, GAL	2000, 1, 90	
S10D-FH	STICK, WC, .120"x 3", PLN	2000, 1, 96	
S10DGAL-FH	STICK, WC, .120"x 3", PLN, GAL	2000, 1, 96	
S10DR	STICK, WC, .120"x 3", RING	2000, 1, 90	
S10DR131GAL	STICK, WC, .131"x 3", RING, GAL	2000, 1, 90	
S10DRGAL-FH	STICK, WC, .120"x 3", RING, GAL	2000, 1, 96	
S10DS	STICK, WC, .120"x 3", SCREW	2000, 1, 90	
S10DSGAL	STICK, WC, .120"x 3", SCREW, GAL	2000, 1, 90	
S12D131EP-AMHDS	STICK, WC, .131"x 3-1/4", PLN, EP	3900, 1, 45	
S12D131-FH	STICK, WC, .131"x 3-1/4", PLN	2000, 1, 88	
S12D131GAL	STICK, WC, .131"x 3-1/4", PLN, GAL	2000, 1, 90	
S12D-FH	STICK, WC, .120"x 3-1/4", PLN	2000, 1, 96	
S12DGAL-FH	STICK, WC, .120"x 3-1/4", PLN, GAL	2000, 1, 90	
S12DR	STICK, WC, .120"x 3-1/4", RING	2000, 1, 90	
S12DR131	STICK, WC, .131"x 3-1/4", RING, DP	2000, 1, 90	
S12DR131GAL	STICK, WC, .131"x 3-1/4", RING, GAL	2000, 1, 90	
S12DS	STICK, WC, .120"x 3-1/4", SCREW	2000, 1, 90	
S12DSGAL	STICK, WC, .120"x 3-1/4", SCREW, GAL	2000, 1, 90	
S12DSS-1M	STICK, WC, .120"x 3-1/4", PLN, SS	1000, 3, 75	

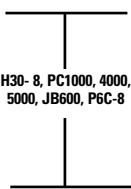
Item Number	Item Description	Pack/Case/Skid	Application Tools	
S SERIES - 28° WIRE COLLATED STICK FRAMING NAILS DP				
S16D131-AMHDS	STICK, WC, .131"x 3-1/2", PLN	2000, 1, 84	 <p>N79WW, N80SB, N86S, N88WW, N100S, F28WW</p>	
S16D131-FH	STICK, WC, .131"x 3-1/2", PLN	2000, 1, 80		
S16D131GAL-FH	STICK, WC, .131"x 3-1/2", PLN, GAL	2000, 1, 80		
S16DS	STICK, WC, .120"x 3-1/2", SCREW	2000, 1, 90		
S16DS131GAL	STICK, WC, .131"x 3-1/2", SCREW, GAL	2000, 1, 84		
S16DSS-1M	STICK, WC, .120"x 3-1/2", PLN, SS	1000, 3, 75		
S20D131	STICK, WC, .131"x 4", PLN	2000, 1, 75		
S20D131-AMHDS	STICK, WC, .131"x 4", PLN, AMH	2000, 1, 75		
CORRUGATED/MITRE FASTENERS				
BA-W9	3/8"H x 1"W COR. FASTENER	9210, 1, 85		BA-T358, CF15-2
BA-W12	1/2"H x 1"W COR. FASTENER	6910, 1, 85	BA-T358, CF15-2	
BA-W15	5/8"H x 1"W COR. FASTENER	5,180, 1, 85	BA-T358, CF15-2	
MC1238	3/8"H x 1/2"W COR. FASTENER	14000, 1, 144	MCF16	
18-GAUGE HEADLESS PINS				
BA-S114P90	S100 PIN 18GA, 9/16" LENGTH	5000, 18, 1512	 <p>BA-T520, S125-569, TU-225-18HP</p>	
BA-S116P80	S100 PIN 18GA, 5/8" LENGTH	5000, 16, 1344		
BA-S119P70	S100 PIN 18GA, 3/4" LENGTH	5000, 14, 1176		
BA-S125P50	S100 PIN 18GA, 1" LENGTH	5000, 10, 840		
23-GAUGE HEADLESS PINS				
BA-S710P288	23GA HEADLESS PIN, 3/8" LENGTH	12000, 24	BA-T410, HP118K,	
BA-S712P240	23GA HEADLESS PIN, 1/2" LENGTH	12000, 20	BA-T410, HP118K	
PT-2312-3M	23GA HEADLESS PIN, 1/2" LENGTH	3000, 60	BA-T410, HP118K	
BA-S714P216	23GA HEADLESS PIN, 9/16" LENGTH	12000, 18	BA-T410, HP118K	
BA-S717P168	23GA HEADLESS PIN, 11/16" LENGTH	12000, 14	BA-T410, HP118K	
PT-2319-3M	23GA HEADLESS PIN, 3/4" LENGTH	3000, 60	HP118K	
PT-2325-3M	23GA HEADLESS PIN, 1" LENGTH	3000, 60	HP118K	
PT-2330-3M	23GA HEADLESS PIN 1-3/16" LENGTH	3000, 60	HP118K	

Item Number	Item Description	Pack/Case/Skid	Application Tools	
ROUND CROWN BOX SPRING STAPLES				
BCS31	3/4" LEG COLL CHIS PTS SAME DIR	28576, 1, 80	BCAR1B-495-92L, BCAR-2S	
BCS31P	3/4" LEG COLL CHIS PTS OPP DIR	28576, 1, 80	BCAR1B-495-92L, BCAR-2S	
1-1/4" WIDE CROWN STAPLE, (.074"x .037"), 5/8" and 3/4" LEGS				
B58C	1-1/4" CRN, 5/8" LEG CTN CLOSING	2400, 10, 42	D19, D19AD	
B34C	1-1/4" CRN, 3/4" LEG CTN CLOSING	2400, 10, 36	D19, D19AD3/4	
SB103020 SERIES - 1/2" CROWN, (.103"x.020"), 3/8" - 5/8" PLIER STAPLES				
SB1030203/82.9M	STPL, 103020, 1/2" CR, 3/8", GAL	2912, 20, 48	P50-10B, P50-10C	
SB1030201/22M	STPL, 103020, 1/2" CR, 1/2", GAL	2100, 20, 48	P50-10B	
SB1030205/82.5M	STPL, 103020, 1/2" CR, 5/8", GAL	2496, 20, 42	P50-10B	
SB5019 SERIES - 1/2" CROWN, (.050"x.019"), 1/4" - 5/8" PLIER STAPLES				
SB50193/8-8M	STAPLE, 3/8" GAL	8064, 10, 60	P50-5B, P50-5C	
SB50191/2-6M	STAPLE, 1/2" GAL	6048, 10, 80	P50-5B	
SB50195/8-4M	STPL, 5019, 1/2" CN, 5/8" GAL	4032, 20, 54	P50-5B	
SBNK SERIES - 1/2" CROWN, (.040"x .023"), 5/32" to 9/16" FINE WIRE STAPLE				
SBNK40233/16	STPL, 4023, 1/2" CN, 3/16" LEG, GAL	10000, 20, 60	 TU20-7, T27-7, T28-11, T31-2, 21684B	
SBNK40231/4-10M	STPL, 4023, 1/2" CN, 1/4" LEG, GAL	10000, 20, 60		
SBNK40235/1610M	STPL, 4023, 1/2" CN, 5/16" LEG, GAL	10000, 20, 48		
SBNK40233/8-10M	STPL, 4023, 1/2" CN, 3/8" LEG, GAL	10000, 20, 36		
SBNK40231/2-10M	STPL, 4023, 1/2" CN, 1/2" LEG, GAL	10000, 20, 30		
SBNK40239/1610M	STPL, 4023, 1/2" CN, 9/16" LEG, GAL	10000, 20, 30		
SL SERIES: 5/16 INCH CROWN (.050" x .035"), 1/2" to 1-1/2" LEGS				
SL50351/2G	STPL, 1/2" LEG, GAL	5000, 10, 100	 S32SL Series, SL150 SB150SLBC SL150, SB150SLBC	
SL50355/8G	STPL, 5/8" LEG, GAL	5000, 10, 80		
SL50353/4G	STPL, 3/4" LEG, GAL	5000, 10, 80		
SL50357/8G	STPL, 7/8" LEG, GAL	5000, 10, 48		
SL50351G	STPL, 1" LEG, GAL	5000, 10, 60		
SL50351-1/8G	STPL, 1-1/8" IN LEG, GAL	5000, 10, 60		
SL50351-3/16G	STPL, 1-3/16" IN LEG, GAL	5000, 10, 60		
SL50351-1/2G	STPL, 1-1/2" IN LEG, GAL	5000, 10, 60		
3/8 INCH CROWN .019" WIRE STAPLE				
SP191/4	STPL 19GA., 3/8" CN, GAL, 1/4" LEG	5000, 40, 96		P3-IND
STCR 2115 SERIES - 7/16 POWERCROWN® STAPLES (.021"x .015") 1/4", 3/8" LEG				
STCR21151/4	STPL, 7/16" CN, GAL, 1/4" LEG	5000, 25, 42	B8P(02245)	
STCR21153/8	STPL, 7/16" CN, GAL, 3/8" LEG	5000, 20, 120	B8P(02245)	
STCR 2619 SERIES - 7/16 POWERCROWN® STAPLES (.026"x .019") 1/4", 5/16", 3/8" LEG				
STCR26191/4	STPL, 7/16" CN, GAL, 1/4" LEG	5000, 40, 72	P6C-6, H30-6	
STCR26195/16	STPL, 7/16" CN, GAL, 5/16" LEG	5000, 20, 120	P6C-6, H30-6	
STCR26193/8	STPL, 7/16" CN, GAL, 3/8" LEG	5000, 20, 96	P6C-6, H30-6	
STCR26191/2	STPL, 7/16" CN, GAL, 1/2" LEG	5000, 20, 72	P6C-6, H30-6	
STCR 5019 SERIES - 7/16 POWERCROWN® STAPLES (.050"x .019") 1/4" to 9/16" LEG				
STCR50191/4-6M	STPL, 7/16" CN, GAL, 1/4" LEG	6048, 20, 63	 H30- 8, PC1000, 4000, 5000, JB600, P6C-8	
STCR50195/16-5M	STPL, 7/16" CN, GAL, 5/16" LEG	5040, 20, 72		
STCR50193/8-5M	STPL, 7/16" CN, GAL, 3/8" LEG	5000, 10, 90		
STCR50193/8SS	STPL, 7/16" CN, STAIN ST, 3/8" LEG	5000, 10, 96		
STCR50191/2-4M	STPL, 7/16" CN, GAL, 1/2" LEG	4032, 10, 90		
STCR50199/16-4M	STPL, 7/16" CN, GAL, 9/16" LEG	4032, 10, 90		
1-3/8 WIDE CROWN STICK PACKAGING STAPLES, (.074 "x .037"), 3/4", 5/8" LEG				
SW74373/4	STPL, 7437, 1-3/8" CN, 3/4", GAL	2400, 10, 36	D16-2, D16-2AD, F84	
SW74375/8	STPL, 7437, 1-3/8" CN, 5/8", GAL	2400, 10, 42	D16-2, D16-2AD, F84	

Item Number	Item Description	Pack/Case/Skid	Application Tools
1-3/8" WIDE CROWN STICK PACKAGING STAPLES, (.090"x .040"), 3/4", 5/8", 7/8" LEG			
SW90403/4	STPL, 9040, 1-3/8" CN, 3/4", GAL	2000, 10, 36	D16-2, D16-2AD, F84
SW90405/8	STPL, 9040, 1-3/8" CN, 5/8", GAL	2000, 10, 42	D16-2, D16-2AD, F84
SW90407/8	STPL, 9040, 1-3/8" CN, 7/8", GAL	2000, 10, 35	D16-2, D16-2AD, F84
1-3/8" WIDE CROWN COIL PACKAGING STAPLES, (.074"x .037"), 1/2", 5/8", 3/4" LEG			
SWC74371/2-1M	COIL (1000), 1/2" LEG	1000, 24, 56	 D60ADC, D61ADC, FC95 Series, SB Series
SWC74371/2-4M	COIL (4000), 1/2" LEG	4000, 6, 54	
SWC74375/8-1M	COIL (1000), 5/8" LEG	1000, 24, 56	
SWC74375/8-4M	COIL (4000), 5/8" LEG	4000, 6, 54	
SWC74373/4-1M	COIL (1000), 3/4" LEG	1000, 24, 56	
SWC74373/4-4M	COIL (4000), 3/4" LEG	4000, 6, 54	
SX SERIES: 7/32" CROWN 18-GAUGE (.050"x.035") STAPLES, 1/4" - 1-1/2" LEG			
SX50353/8G	STPL, 5035, 7/32" CN, 3/8" LEG, GAL	5000, 10, 100	 S32SX Series, SX150 Series, SB150SX
SX50351/2G	STPL, 5035, 7/32" CN, 1/2" LEG, GAL	5000, 10, 100	
SX50351/2G-8408	STAPLE F.BLACK, 1/2" LEG, GAL	5000, 10, 100	
SX50355/8CCPG	5/8" LEG, Crosscut Point, GAL	5000, 10, 64	
SX50355/8G	STPL, 5035, 7/32" CN, 5/8" LEG, GAL	5000, 10, 80	
SX50353/4CCPG	CROSS-CUT POINT, 3/4" LEG, GAL	5000, 10, 64	
SX50353/4G	STPL, 5035, 7/32" CN, 3/4" LEG, GAL	5000, 10, 80	
SX50353/4G-0400	STAPLE WHITE, 3/4" LEG, GAL	5000, 10, 80	
SX50353/4G-0527	STAPLE BROWN, 3/4" LEG, GAL	5000, 10, 80	
SX50353/4G-0592	STAPLE L.BROWN, 3/4" LEG, GAL	5000, 10, 80	
SX50357/8G	STPL, 7/8" LEG, GAL	5000, 10, 64	
SX50351G	STPL, 1" LEG, GAL	5000, 10, 60	
SX50351G-0400	STAPLE WHITE, 1" LEG, GAL	5000, 10, 60	
SX50351G-0592	STAPLE L.BROWN, 1" LEG, GAL	5000, 10, 60	
SX50351G-0596	STAPLE, D.BROWN, 1" LEG, GAL	5000, 10, 60	
SX50351-1/8DP	FRN STPL, 1-1/8" LEG, DIVPT, GL	3000, 10, 72	
SX50351-1/8G	STPL, 1-1/8" LEG, GAL	3000, 10, 80	
SX503511/8G0400	STPL, 1-1/8" LEG, GAL, WHITE	3000, 10, 80	
SX503511/8G0596	STPL, 1-1/8", GAL, D. BROWN	3000, 10, 80	
SX50351-3/16G	STPL, 1-3/16" LEG, GAL	3000, 10, 80	
SX50351-1/4G	STPL, 1-1/4" LEG, GAL	3000, 10, 80	
SX503511/4G0400	STPL WHITE, 1-1/4" LEG, GAL	3000, 10, 80	
SX50351-3/8G	STPL, 1-3/8" LEG, GAL	3000, 10, 60	
SX503511/2G	STPL, 1-1/2" LEG, GAL	3000, 10, 48	

ANCHOR CLIPS

For attaching sinuous springs to chair, sofas, etc.

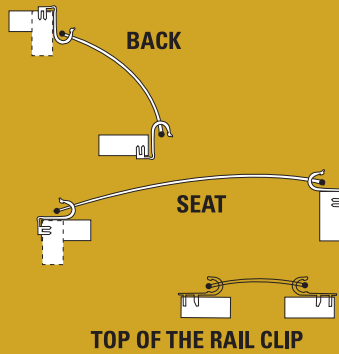

LOCKNAILS

For attaching upholstery panels



CLINCH CLIPS

Fasten two or more wires together to unitize or stabilize the finished product.

CCP- Continuous Coils, Polycord Collated
CLP- Polycord Collated, 12" sticks (25-45 count)

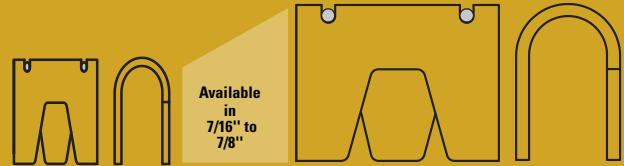

SPRING ANCHOR CLIPS

Part #	Description	Clip/Coil	Coil/Case	Coil/Skid	Application Tool
*HR-AK-1EW	Spring Anchor - Seats (Larger Hook) Everwear Lining with Fold Over	1000	1	30	AK Machine
*HR-AK-2	Spring Anchor Clip - Backs (Smaller Hook) - Glued Liner	1000	1	30	AK Machine
*HR-AK-3	Spring Anchor Clip for Drop-in Units, Rail, Staple Holes - Glued Liner	1000	1	30	AK Machine
*HR-AK-4	Spring Anchor Clip for Drop-in Units (6-Gauge), Glued Liner	1000	1	30	AK Machine
HR-OSK	Bulk Over the Rail Seat Clip Everwear Lining with Fold Over	3000	1	36	T40S5CLP, 438S5
*HR-TRK-EW	Top of the Rail Clip Everwear Lining with Fold Over	1250	1	24	TRK Machine

LOCKNAIL FOR UPHOLSTERY PANELS

*HR-LN-2	3/4" Long Locknail	2500	1	40	HR-LN
*HR-LN-3	15/16" Long Locknail	2500	1	40	HR-LN

COILED CLIP CLINCHING TOOLS

Tool Part #	Description	Typical Applications	Clip Numbers CCP
HR-48CCP	Model 48 Coil Clip Tool with Feed	Bedding	33, 32
HR-49CCP	Model 49 Coil Clip Tool with Feed	Bedding	13, 19, 26

CLIP CLINCHING TOOLS

Tool Part #	Description	Typical Applications	Clip Numbers CL, CLP
HR-45	Model 45 Clipping Tool, Square Blade	Cages w/hinge Applications	13
HR-45TN	Model 45 Clipping Tool, Thin and Narrow Blade and Anvil	Animal Cages, Bird Feeders w/1/2 in. Grid	13
HR-61	Model 61 Clipping Tool	Security Fence, Concertina	61
HR-65C-130	Model 65C Light Clipping Tool	Furn., including Hi Loop Sinuous w/Reduced Clearance	2312, 23, 2412, 24, 29
HR-66C-110	Model 66C Light Clipping Tool, Angle Blade	Furniture, Concrete Reinforcement wire	312, 3, 4
HR-68C-100	Model 68C Light Clipping Tool	Automotive and Furniture, Non-Domestic	20
HR-85C-100	Model 85C Light Clipping Tool, Square Blade	Drop-In Units, Pet Cages w/Hinge Applications	34
HR-85C-110	Model 85C Light Clipping Tool, Angle Blade	Bedding, Rebuilders and Custom Size Units	312, 3, 4, 34
HR-86C-100	Model 86 Light Clipping Tool, Square Blade	Pet Cages, Concrete Slabs, Pipe	36
HR-86C-110	Model 86C Light Clipping Tool	Lobster Traps, 7/8 Clips	34AL, 36AL, 34NAL, 36NAL
HR-86C-170	Model 86C Light Clipping Tool, Thin and Narrow Blade and Anvil	Lobster Traps, 3/4 clips only, 1in. x 1in. Grid	34NAL, 36NAL
HR-85SB10	Model 85S10 Light Clipping Tool	Bedding, Foundations, Non-Domestic	36-10
HR-88B	Model 88 Light Clipping Tool	Bedding, Concrete Slabs, Pipe	38

COILED CLINCH CLIPS 7/16" WIDE

MATERIAL: COLD ROLLED STEEL, APPLICATION: MATTRESS INNERSPRING TO BORDERWIRE ASSEMBLY

Clip Part#	W x H x Crown Dia (opening)	Clip/Coil	Coil/Skid	Application Tool
*HR-CCP-15	7/16 x 25/64 x 11/64	15250	48	HR-50CC (Available, Consult Factory), VRC Machine
*HR-CCP-13	7/16 x 27/64 x 11/64	15625	48	HR-49CC, VRC Machine
*HR-CCP-19	7/16 x 15/32 x 11/64	12500	48	HR-49CC, VRC Machine
*HR-CCP-26	7/16 x 1/2 x 11/64	12500	48	HR-49CC, VRC Machine
*HR-CCP-33	7/16 x 33/64 x 13/64	11750	48	HR-48CC, VRC Machine
*HR-CCP-32	7/16 x 35/64 x 13/64	9375	48	HR-48CC, VRC Machine

* Sold in Skid Quantities Only (Clip/Coil x Coil/Skid)

ALUMINUM CLINCH CLIPS (TAPE COLLATED)

MATERIAL: ALUMINUM, APPLICATIONS: LOBSTER TRAPS/CORROSIVE ENVIRONMENTS

Clip Part#	W x H x Crown Dia (opening)	Clip/Pack	Pack/ Case	Case/Skid	Application Tool
HR-CL-4AL	7/8 x 35/64 x 7/32 Aluminum Clip	2880	1	60	HR-55B, HR-66B, HR-85BA, HR-85BF, HR-85C-110
HR-CL-34AL	7/8 x 43/64 x 7/32 Aluminum Clip	2160	1	60	HR-85SBL, HR85SBLT, HR-86C-110
HR-CL-34NAL	3/4 x 43/64 x 7/32 Aluminum Clip	2376	1	60	HR-85SBLN, HR-85SBLTN, HR-86C-170
HR-CL-36AL	7/8 x 23/32 x 1/4 Aluminum Clip	2040	1	60	HR-85SBL, HR85SBLT, HR-86C-110
HR-CL-36NAL	3/4 x 23/32 x 1/4 Aluminum Clip	2244	1	60	HR-85SBLN, HR-85SBLTN, HR-86C-170

REGULAR CLINCH CLIPS (TAPE COLLATED)

Application: Caging requiring post galvanization, bedding

HR-CL-36-10	5/8 x 23/32 x 1/4 Tape Collated Clip	2856	1	60	HR-85SB10
HR-CL-36T	7/8 x 23/32 x 1/4 Tape Collated Clip	2040	1	60	HR-85B F5, HR-86C-100
HR-CL-38T	7/8 x 27/32 x 5/16 Tape Collated Clip	1400	1	60	HR-88B

REGULAR CLINCH CLIPS (POLYCORD COLLATED)

MATERIAL: COLD ROLLED STEEL UNLESS OTHERWISE SPECIFIED,

APPLICATION: UPHOLSTERED FURNITURE/BEDDING/AUTO SEATS/CAGES/WIRE FORMS FOR CONCRETE PIPE

HR-CLP-20	11/16 x 7/16 x 11/64 Poly Collated Clip	4860	1	60	HR-68B, HR-68C-100
HR-CLP-23	7/8 x 1/2 x 11/64 Poly Collated Clip	3600	1	60	HR-65BAH, HR-65BAT, HR-65BSH, HR-65C-130
HR-CLP-2312	3/4 x 1/2 x 11/64 Poly Collated Clip	3960	1	60	HR-65BAH, HR-65BAT, HR-65BSH, HR-65C-130
HR-CLP-24	7/8 x 39/64 x 11/64 Poly Collated Clip	3150	1	60	HR-65BAH, HR-65BAT, HR-65BSH, HR-65C-130
HR-CLP-2412	3/4 x 39/64 x 11/64 Poly Collated Clip	3465	1	60	HR-65BAH, HR-65BAT, HR-65BSH, HR-65C-130
HR-CLP-29	7/8 x 37/64 x 11/64 Poly Collated Clip	3150	1	60	HR-65BAH, HR-65BAT, HR-66C-130
HR-CLP-3	7/8 x 15/32 x 7/32 Poly Collated Clip	3600	1	60	HR-55B, HR-66B, HR-66C-100, HR-66C-110
HR-CLP-312	3/4 x 15/32 x 7/32 Poly Collated Clip	3564	1	60	HR-55B, HR-66B, HR-85BA, HR-66C-100, HR-66C-110
HR-CLP-34	7/8 x 43/64 x 7/32 Poly Collated Clip	2160	1	60	HR-85BA, HR-85BF, HR-85C-100, HR-85C-110
HR-CLP-4	7/8 x 35/64 x 7/32 Poly Collated Clip	2520	1	60	HR-55B, HR-66B, HR-85BA, HR-85BF, HR-66C-100, HR-66C-110, HR-85C-110

CUSHION CLIPS (Paper Lined, Polycord Collated)

MATERIAL: COLD ROLLED STEEL/CRAFT PAPER TAPE LINING,

APPLICATION: UPHOLSTERED FURNITURE/BEDDING/AUTOSEATS, ELIMINATES NOISE/SQUEAKING

HR-CLP-22C	7/8 x 7/16 x 11/64 Cushion Clip	4500	1	60	HR-65BAH, HR65BAT, HR-65C-130
HR-CLP-2312C	3/4 x 1/2 x 11/64 Cushion Clip	3960	1	60	HR-65BAH, HR65BAT, HR-65C-130
HR-CLP-23C	7/8 x 1/2 x 11/64 Cushion Clip	3600	1	60	HR-65BAH, HR65BAT, HR-65C-130
HR-CLP-24C	7/8 x 39/64 x 11/64 Cushion Clip	3150	1	60	HR-65BAH, HR65BAT, HR65BSH, HR-65C-130
HR-CLP-34C	7/8 x 43/64 x 7/32 Cushion Clip	2160	1	60	HR-85B, HR-85BA, HR85BF, HR-85C-100, HR-85C-110
HR-CLP-36C	7/8 x 23/32 x 1/4 Cushion Clip	2040	1	60	HR-85BS, HR-85BSF, HR-86C-100
HR-CLP-4C	7/8 x 35/64 x 7/32 Cushion Clip	2880	1	60	HR-66B, HR85BA, HR-85BF, HR-66C-110, HR-85C-110

GALVANIZED CLINCH CLIPS

APPLICATIONS: CAGES/FENCING/CORROSIVE ENVIRONMENTS

HR-CLP-13G	7/16 x 27/64 x 11/64 Galvanized Clip	9000	1	60	HR-45, HR-45A
HR-CLP-2412G	3/4 x 39/64 x 11/64 Galvanized Clip	3465	1	60	HR-65BAH, HR-65BAT, HR-65BSH, HR-65C-130
HR-CLP-24G	7/8 x 39/64 x 11/64 Galvanized Clip	3150	1	60	HR-65BAH, HR-65BAT, HR-65BSH, HR-65C-130
HR-CLP-34G	7/8 x 43/64 x 7/32 Galvanized Clip	2160	1	60	HR-55B, HR-85B, HR-85BA, HR-85BF, HR-85SB, HR-85C-100, HR-85C-110
HR-CLP-61G	7/16 x 43/64 x 11/32 Galvanized Clip	3360	1	60	HR-61

RING DESCRIPTORS

AL=Aluminum

BT=Blunt Tip (nothing means sharp tips)

RG and G=Regular Galvanized

BB=Brite Basic

HTGL=Hi-Tensile Galvanized

SS=Stainless

TOOLS	RING TYPE	WIRE SIZE	RING SIZE	CLOSURE SIZE (I.D. MIN.-MAX.)	RING PART	RING DESCRIPTION	RING/ PACK/ CASE	PACK CASE	CASE/ SKID
1 SC73462	C	16 GA	3/8"	1/16"-1/18", 1.6-3.2mm	RING316AL130B	3/32 16GA AL CRING BT	13000	1	100
2 SC760, SC760CT, SC761	C	16 GA	1/2"	SC760, SC760CT: 1/8"-7/32", 3.2-5.6mm, SC761: 3/16"-7/32", 4.8-5.6mm	RING516G100 RING516G100B RING516SS100 RING516SS100B	1/2 16GA GL CRING 1/2 16GA GL CRING BT 1/2 16GA SS CRING 1/2 16GA SS CRING BT	10000 10000 10000 10000	1 1 1 1	100 100 100 100
3 SC7, SC7C, SC7E, SC77XE	C	15 GA	3/4"	SC7, SC7E, SC77XE, SC4LWH: 5/16"-27/64", 7.9-10.7mm SC7C: 3/16"-11/32", 4.8-8.7mm	RING15100B RING15100P RING15G100B RING15G100P RING15SS100B	3/4 15GA BB CRING BT 3/4 15GA BB CRING 3/4 15GA GL CRING BT 3/4 15GA GL CRING 3/4 15G SS CRING BT	10000 10000 10000 10000 10000	1 1 1 1 1	100 100 100 100 100
4 SC742, SC743,	C	16 GA	3/4"	SC742 (Short Mag.), SC743: 3/16"-11/32", 4.8-8.7mm	RING16G110 RING16G110B RING16SS110	3/4 16GA GL CRING 3/4 16GA GL CRING BT 3/4 16GA SS CRING	11000 11000 11000	1 1 1	100 100 100
5 TR201, TR203, TR315	D	15 GA	3/4"	1/4"-3/8", 6.4-9.6mm	RINGSR15 RINGSR15SS	3/4 15GA BB BOST DRING 3/4 15GA SS BOST DRING	10000 1000	1 1	100 100
6 RINGER9/16	D	16 GA	9/16"	3/16", 4.8mm	RINGR15G50 RINGR15G50B RINGR15SS50 RINGR15SS50B	9/16 15GA GL DRING 9/16 15GA GL DRING BT 9/16 15GA SS DRING 9/16 15GA SS DRING BT	2500 2500 2500 2500	10 10 10 10	60 60 60 60
7 P7	C	16 GA	11/16"	9/32" - 23/64", 7.1mm- 9.1mm	RING616G50 RING616G50B RING616SS50	1/2 16GA GL CRING 1/2 16GA GL CRING BT 1/2 16GA SS CRING	2500 2500 2500	10 10 10	60 60 60
8 HFP9	D	9 GA	1-3/16"	7/16", 1.1mm	RING09AL25	1 1/2 9GA AL DRING BT	2500	1	100
9 SC50T, SC50HP	C	11 GA	1-1/2"	9/16"-5/8", 14.3-15.9mm	RING11AL40 RING11RG40 RING11RG40B RING11SS40	1 1/2 11GA AL CRING 1 1/2 11GA RGL CRING 1 1/2 11GA RGL CRING BT 1 1/2 11GA SS CRING	1600 1600 1600 1600	1 1 1 1	96 96 96 96

ADDITIONAL RINGS

RING PART	DESCRIPTION	RING/PACK	PACK/CASE	CASE/SKID
RING516N50P	1/2 16G BB DRING	10,000	1	100
RINGCC16G10M	3/4 16G BB CONT. COIL CRING	10,000	13	4
RINGCC16SS10M	3/4 16G SS CONT. COIL CRING	10,000	13	4
RINGHR14SS	14MM 17GA SS DRING	10,000	1	100
RING14NSPHR	3/4 14G BB SUPER POLISHED DRING LOOSE	11,000	Rings/25lbs box	
RING315AL100	3/32 15G AL CRING	10,000	1	100
RING1714G100S	1-1/16 14GA CL CRING BT	5,000	1	100



TOOL DESCRIPTORS

C=Tight Closure E=Extended Nose

XE=Extra, Extended Nose

SUGGESTED APPLICATIONS

	Small bag closure, picture wire, small caging, arts and crafts, cords, cables, light wire to wire
	Bungee (w/SC760), oil absorption socks, small dia. auto controls, small rope, bag closure and elec. strain relief Bungee (w/SC760), oil absorption socks, small dia. auto controls Insulation, lobster bait bag, cargo nets Bag closure, netting, bait bag, traps, pots and cages (crab, eel, shrimp, lobster, mink, bird, ect)
	Automotive seating, bagging, bungee (w/SC7C) Bedding (ticking to innerspring/borderwire, pocketed coils), auto seats, upholstery Bungee, caging, auto control cables, ropes Automotive seating Caging, insulation, silt fence, rope tying
	Nursery (root ball), caging, auto seats, bedding Bagging, oil socks, novelty items, components Lobster trap heads (w/SC742 short mag.), bait bag (w/SC742), insulation, novelty/components Lobster traps heads (w/SC742 short mag.), bait bag, insulation, novelty/components
	Furniture, bedding, ticking to innerspring Novelty, components
	Nursery pot tagging, crafts, bag closure Tagging, bagging Trap and cage repair Lobster traps heads, bait bags
	Nursery (root ball, pot tagging), bagging, crafts Bagging, crafts Bird control netting
	Fence tensioning wire, signs, mending, bundling, bagging, crafts, stringing lights Garland on wire, component assembly
	Fencing/large bagging, stringing lights and garland to wire Fencing, large bagging, concrete reinforcement wire, rubber tree staking (nursery) Concertina wire, control cables Garland, lighting (stringing on wire), electrical cable strain relief, rope to mesh, bungee cords Oil absorption socks

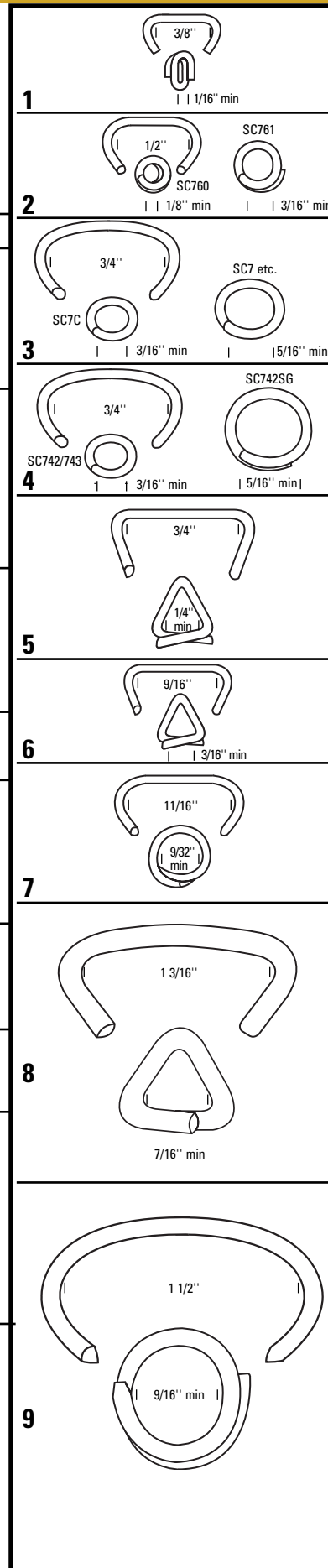

Airline Hoses:

Item Number	Description
BC590A	3/8" X 50' Industrial 2 Ply Braided Rubber Airline w/crimped-on Industrial Series Fittings
BC590C	3/8" X 50' Lightweight Flexible Vinyl Airline w/crimped-on Industrial Series Fittings



PROZHOZE[™] Premium Quality Air Hose



PRO-1450	1/4" x 50' Premium quality polyurethane air hose
PRO-14100	1/4" x 100' Premium quality polyurethane air hose
PRO-3850	3/8" x 50' Premium quality polyurethane air hose
PRO-38100	3/8" x 100' Premium quality polyurethane air hose

Miscellaneous Kits:

Item Number	Description
112670	N64C Aluminum Feed Door Kit
BAL5N	Tool Balancer < 10 lbs.
132979	Tool Balancer for < 10 lbs.
MTCKA3	SC50T Touch trip, bagging guide, mount bracket kit
MTCKA50	SC50T Foot valve, bagging guide, mount bracket kit.
MTCKA9	SC7 series touch trip bagging guide and mounting kit
N62-MAGKIT	N62 Magazine Assembly
N88RH-MCNOSE	Metal connector kit
N88WW-SMAGK	N88WW Short Magazine Assembly
SEQ1	Sequential Trigger Conversion Kit (For tools produced prior to 11/96)
SEQ3	Sequential Trigger Conversion Kit (For tools produced after 11/96)
SEQ4	N88 Sequential Trigger Conversion Kit
SCK014	SC7 Manifold kit for balancer
SCK015	SC77 Manifold kit for balancer
VSA2	Vinyl Siding Adapter for RN45 Roofing Nailer

Bumper Kits:

Item Number	Description
BK3	N70 / N80 Bumper Kit
BK4	N12 / N55 Bumper Kit
BK11	RN45 Bumper Kit
BK12	N63CP / N64C Bumper Kit
N88BK	N88 Bumper Kit



Lubricants and Oils:

Item Number	Description	Size
BC601	Industrial Pneumatic Tool Lubricant	4 Ounces
BC602	Industrial Pneumatic Tool Lubricant	1 Pint
BC603	Industrial Cold Weather Pneumatic Tool Lubricant	1 Pint
BC604	Industrial Pneumatic Tool Lubricant	1 Quart
851871	Air Compressor Oil	1 Quart
120672	Tube Lubrication Grease	10 Ounces





851462K
Light Series
Connector Plug
1/4" MPT



851683K
Light Series
Connector Plug
1/4" FPT



86517K
Industrial Series
Connector Plug
3/8" MPT



86522K
Industrial Series
Connector Plug
1/4" MPT



86546K
Industrial Series
Connector Plug
3/8" FPT



851461K
Light Series Quick
Coupler
3/8" MPT



851684K
Light Series Quick
Coupler
1/4" FPT



86523K
Industrial Series
Quick Coupler
1/4" MPT



86551K
Industrial Series
Quick Coupler
3/8" FPT



87103K
Industrial Series
Quick Coupler
3/8" MPT



851393K
3/8" Airline
Splicing Kit



89404K
Industrial Series
In-Line Lubricator
1/4" NPT



89654K
Industrial Series
In-Line Lubricator
3/8" NPT



852059K
3-Way
Manifold
1/4" FPT



852058K
Sealant Tape



851870
Combination
Regulator
& Air Filter w/ Gauge
1/4" FPT



86503
Industrial Series
Air Filter
3/8" NPT



86504
Industrial Series
Regulator w/ Gauge
3/8" NPT



89403
Industrial Series Mini
Regulator w/ Gauge
1/4" NPT



850541K
Industrial
Blow Gun
1/4" FPT



851397K
Tire Inflator
Chuck
1/4" FPT



851460K
Solid Brass
Tee Fitting
3/8" FPT



851869
Solid Brass
Tee Kit
3/8" NPT

APPLICATION	PAGES	APPLICATION	PAGES
Automotive Control Cables	40-42	Insulation Heat/Sound	44
Automotive Seating	40-42	Joint Assembly	19, 25
Automotive Trim Assembly	42	Labeling	16, 32, 36
Bag Closure Sealing	39	Lightweight Manufacturing	36
Bait Bag Closure	40, 41	Lobster, Crab, Eel Pot Assembly	40, 41, 43
Barbed Tape Loop Assembly	44	Log Home Construction	23
Boat Seating	16	Machine Mount	40
Borderwire Assembly to Innerspring	29	Mattress Re-building	28
Borderwire Overlap Connections	28	Metal Connector/ Joist Hanger	21-22
Box Closing	36-38	Netting Assembly	40, 41, 43
Box Frame Assembly, Build-Up	27	Novelty/Crafts	40, 41, 43
Bungee Loop Forming	38-39, 44	Nursery Applications	44
Cabinet Assembly	25	Oil Absorption Socks	40, 41
Cabinet Face Frame Assembly	19	Pallet (Block) Assembly	10
Cage Assembly	40, 41, 43	Pallet (Hardwood) Assembly	10
Cargo Netting	40, 41	Pallet (Stringer) Repair	11, 23
Carton Sealing/Closing	36-38	Pallet Assembly	10
Carton to Pallet Connecting	38	Pallet Repair	10
Case Back Assembly	19, 25	Partial Overlap Carton Sealing	38
Case Goods Structural Assembly	17	Pinning, Decorative Molding	19
Concertina Wire Assembly	44	Pocket Coil to Pocket Coil	27
Concrete Pipe Re-enforcement	41, 42	Pole Barn Framing	23
Container Sealing	37, 38	Pot Assembly	40, 41, 43
Corner Block Connection,	16, 18	Pot Tagging (Nursery)	44
Corner Guards to Frame	28	Pre-Cast Concrete Re-enforcement	41, 42
Corrugated to Wood	16, 38	Propex to Frame	16, 28
Crafts Assembly	40, 41	Razor Wire Loop Assembly	44
Crate Assembly	9-11	Ring Assembly (Chain Link Crafts)	43
Crate Framing	11	Roofing	23, 24
Decorative Trim Attachment	15, 16, 18	Roofing Felt Attachment	24
	19, 32	Root Ball Tightening	44
Door Frames	18, 33	Rope Loop Forming	41, 44
Door Stile Assembly	19, 25	RV Trim Assembly	42
Double Welt Attachment	15	Sheathing Construction	22, 23, 24
Drawer Assembly	19, 25	Sheet Metal/Wood Assembly	23
Drug Store Bagging	36	Shipping Room Packaging	36, 37, 38, 39
Dry Cleaning Tagging	36, 37	Siding	23
Drywall Attachment	24	Silt Fencing Assembly	44
Drywall Exterior Attachment	24	Sinuous Spring to Stabilizing Wire	14
Duplex Nailing	22, 47	Spring Clip to Chair Rail	14
Edge Roll to Borderwire	15	Spring Up	14, 16, 27
Electrical Cable Assembly	42	Spring Up, Box Frame	27
End Cap Fabrication	37	Steel Band to Seat Rail	14
Engineered Lumber Framing	22	Tie Wire to Sinuous Spring	14
Fabric Stapling, Loop	38	Timber Framing	23
Fabric to Cardboard	28	Trap Assembly	40, 41, 43
Fabric to Wood frame	16, 28	Tray (Vegetable)	38
Fence (Panel) Assembly	10	Tree Support	40, 41, 44
Fence (Picket) Assembly	10	Trim Work	19, 25
Fence Sign Attachment	11	Truss Assembly	23
Fence tensioning Wire Attachment	11	Underlayment	25
Flange to Foam	28	Upholstery Panels	15
Flange to Innerspring / Borderwire	27	Window Frames	18, 33
Flat Assembly (Box Frame)	27	Wire to Wire	40, 41
Flooring	23		
Flower Wrapping	36, 37		
Foundation/ Box Spring Assembly	28		
Framing Construction	22		
Furniture Assembly	14-16		
Furniture Frame Knock-up	15		
Furniture Packaging	16		
Garland Applications	40-41		
Header Card Attachment	36		
House Wrap Attachment	24		

PART #	DESCRIPTION	APPLICATION
27G5	27 Gauge Gal 5lb spool	Bookbinder Wire
25G70	25 Gauge Gal 70lb spool	Bookbinder Wire
25G5	25 Gauge Gal 5lb spool	Bookbinder Wire
25G40	25 Gauge Gal 40 lb spool	Bookbinder Wire
25G250	25 Gauge Gal 250lb spool	Bookbinder Wire
24G70	24 Gauge Gal 70 lb spool	Bookbinder Wire
24G5	24 Gauge Gal 5 lb spool	Bookbinder Wire
24G40	24 Gauge Gal 40 lb spool	Bookbinder Wire
24G250	24 Gauge Gal 250 lb spool	Bookbinder Wire
24G10	24 Gauge Gal 10 lb spool	Bookbinder Wire
23G5	23 Gauge Gal 5 lb spool	Bookbinder Wire
23G40	23 Gauge Gal 40 lb spool	Bookbinder Wire
2125G5	21 x 25 Ga. Rectang. Gal, 5 lb spool	Stitcher Wire
2024G5	20 x 24 Ga. Rectang. Gal, 5 lb spool	Stitcher Wire
2024G10HT	20 x 24 Ga. Hi-Tensile, Gal, 10 lb spool	Bookbinder Wire
18G10LT	18 Gauge Gal, 10 lb spool Low Tensile	Bookbinder Wire
17G10LT	17 Gauge Gal 10 lb spool Low Tensile	Bookbinder Wire
103017G25	BOX STAY WIRE 25 lb spool, Gal	Carton Closing Wire
103017C10	BOX STAY WIRE 10 lb spool, Liquor	Carton Closing Wire
103020G10	BOX STAY WIRE 10 lb spool, Gal	Carton Closing Wire
103020C10	BOX STAY WIRE 10 lb spool, Liquor	Carton Closing Wire
103020G25	BOX STAY WIRE 25 lb spool, Gal	Carton Closing Wire
103020C25	BOX STAY WIRE 25 lb spool, Liquor	Carton Closing Wire
103023C25	BOX STAY WIRE 25 lb spool, Liquor	Carton Closing Wire
103023G25	BOX STAY WIRE 25 lb spool, Gal	Carton Closing Wire
074037C25	BOX STAY WIRE 25lb spool, Liquor	Carton Closing Wire

Washburn & Moen (W & M) Custom Wire Gauge Chart.

Consult your rep or factory.
We have the capability to draw
and package wire in the
following sizes:

Gauge	Inches	
27	.0173	•
26	.0181	•
25	.0204	•
24	.0230	•
23	.0258	•
22	.0286	•
21	.0317	•
20	.0348	•
19	.0410	•
18	.0475	•
17	.0540	•
16	.0625	•
15	.0720	•
14	.0800	•
13	.0915	•
12	.1055	•
11	.1205	•
10	.1350	•
9	.1483	•
8	.1620	•

TOOL INDEX

REGULAR TYPE: fastener and tool part number guides **BOLD:** application and specification information

TOOL NUMBER	PAGE	TOOL NUMBER	PAGE	TOOL NUMBER	PAGE
02245	39, 56	HR-88B	42, 56	TR203	15, 28, 54, 57
21671B	16, 28, 42, 56	HR-CL-36T	42	TR315	15, 28, 54, 57
21671B-A	16, 42, 56	HR-CL-38T	42	TU-225-18HP	19, 32, 57
21671B-ALM	16, 42, 56	HR-CLP-24	42	US056-1	24
21671B-LM	16, 28, 42, 56	HR-CLP-34	42	VRC Machine	29
21671B-LN	16, 42, 56	HR-CLP-4	42		
21680B	28, 56	HR-LN	15, 56		
21680B-LN	28, 56	JB600	36, 57		
438S2	18, 27, 56	LockNail System	15		
438S2R	24, 56	MCF16	19, 33, 57		
438S4	18	MCN150	22, 57		
438S5	27, 56	MCN250	22, 57		
438S5 Clip Kit	14, 56	N400C-1	10, 57		
450S2	16, 24, 33, 38, 56	N52FN	16, 18, 25, 32, 57		
538S214-1	23, 56	N58C-1	10, 23, 27, 33, 43, 57		
538S4	11, 14, 23, 33, 56	N62FN	16, 18, 25, 32, 57		
538S5	11, 14, 56	N64084-1	10, 57		
650S4	15, 18, 23, 33	N64099-1	10, 57		
650S5	15, 18, 23, 33, 56	N66BC-1	24, 57		
750S4	11, 18, 56	N70CB	10, 57		
750S5	11, 18, 24, 56	N80CB	10, 22, 57		
850S4	11, 56	N89C-1P	10, 57		
863S4	23, 56	P3-IND	36, 57		
AK/TRK Semi Automatic	14	P50-10B	38, 57		
AK/TRK Automatic	14	P50-5B	38, 57		
BCAR1B-495-92I	27, 56	P6C-6	36, 57		
BCAR-2S	27, 56	P6C-8	36, 57		
BIGBERTA160-2	23, 56	P6C-8F	39		
BT125	15, 18, 25, 32, 56	P6C-8P	36		
BT200	15, 18, 25, 32, 56	P7	39, 44, 54, 57		
BT35	15, 18, 25, 32, 56	PC3000	36		
BT50	15, 18, 25, 32, 56	PC3000-OC2	36		
CF15-2	11, 18, 33, 56	PC4000	36		
Coil Clip System	29	PC4000-OC1	36		
D16-2	37, 56	PC4000-OC2	36		
D16-2AD	37, 56	RINGER9/16	43, 44, 54, 57		
D19	37, 56	RN46	25, 57		
D61ADC	37, 56	S3297	18, 57		
D61ADCSB	38, 56	S32SL	15, 18, 25, 32, 57		
ESD-450S2P	38, 56	S32SX	15, 18, 25, 32, 57		
F21PL	22, 56	SB150SLBC-1	24, 57		
F28WW	22, 56	SC4LWH	42		
F33PT	22, 56	SC50HP	42, 43, 44, 54, 57		
F84	37, 56	SC50T	39, 42, 43, 44, 54, 57		
FC95EC	37, 56	SC7	27, 39, 42, 44, 54, 57		
FN16250	32, 56	SC73462	54, 57		
HFP9	11, 39, 43, 54, 56	SC742	43, 54, 57		
HP118K	19, 32, 56	SC743	39, 44, 54, 57		
HR-45	43, 56	SC760	39, 54, 57		
HR-45TN	43	SC760CT	54		
HR-61	43, 56	SC761	39, 44, 54, 57		
HR-65C-110	14, 56	SC77XE	42, 54, 57		
HR-65C-130	14, 42, 56	SC7C	27, 39, 42, 54, 57		
HR-66C-110	42, 56	SC7E	42, 54, 57		
HR-85C-100	42, 43, 56	SL125OC-2	28, 57		
HR-85SB	42	SL150	15, 18, 25, 57		
HR-86C-100	42, 43, 56	SX150	15, 18, 25, 57		
HR-86C-110	43, 56	TR201	15, 18, 25, 57		
HR-86C-170	43, 56				

ITEM NUMBER	ITEM DESCRIPTION	ITEM NUMBER	ITEM DESCRIPTION
02245	B8P STAPLING PLIER	851394K	1/4IN HOSE SPLICER
106427	400&500 CAP REMOVAL WRENCH	851397K	1/4IN TIRE INFLATOR
107205	WEIGHT KIT 700,800 SERIES STAPLER	851460K	3/8IN PIPE TEE
107306	WEIGHT KIT 600 SERIES STAPLER	851461K	3/8 X 1/4 LIGHT QUICK COUPLER
108072	650S4 LONG MAG. KIT	851462K	1/4IN LIGHT QUICK CONECTOR
108074	750S4 LONG MAG KIT	851683K	1/4IN QUICK CONNECTOR
108075	750S5 LONG MAG. KIT	851684K	1/4IN QUICK COUPLER
108076	850S4 LONG MAG. KIT	851754	TOUCH-UP PAINT, BOSTITCH GOLD
108077	863S4 LONG MAG. KIT	851867K	GAUGE,AIR 2IN
108212	400 & 500 S2 LONG MAG. KIT	851868K	GAUGE,AIR 1-1/2IN
108214	400 & 500S5 LONG MAG KIT	851869	3/8 NPT TEE KIT
108550	438&538S4 VINYL SIDING TRIP	851870	REGULATOR & FILTER L/1 PC. 1/4 FPT
108551	650S4 VINYL SIDING TRIP	851871	AIR COMPRESSOR OIL-QUART
112603	WEIGHT KIT 500 SERIES STAPLER	852058K	SEALANT TAPE
112604	WEIGHT KIT 400 SERIES STAPLER	852059K	3 WAY MANIFOLD 1/4" FPT
112670	KIT,PLASTIC COLLATION N63,N64	863S4-1	TACKER,S4,2-1/2IN MAX
108073	650S5 LONG MAG KIT	863S4-2	TACKER,,S4,2-1/2IN SEQ
216718-A	71 SERIES STAPLER AUTO	86503	FILTER,3/8 NPT
216718-ALM	71 SERIES STAPLER AUTO LG MAG	86504	REGULATOR & GAGE 3/8 NPT
216718-LM	71 SERIES STAPLER LG MAG	86517K	3/8IN MPT QUICK CONNECTOR
216718-LN	71 SERIES STAPLER LG NOSE	86522K	1/4IN MPT QUICK CONNECTOR
21671B	71 SERIES STAPLER	86523K	1/4IN MPT QUICK COUPLER
21680B	80 SERIES STAPLER	86546K	3/8IN FPT QUICK CONNECTOR
21680B-ALM	80 SERIES STAPLER AUTO LG MAG	86551K	3/8IN FPT QUICK COUPLER
21680B-LM	80 SERIES STAPLER LG MAG	87103K	3/8IN MPT QUICK COUPLER
21680B-LN	80 SERIES LONG NOSE	89403	1/4 NPT REGULATOR W/ GA.
21684B	84 SERIES STAPLER	89404K	1/4NPT IN-LINE LUBRICATOR KI
21697B	97 SERIES STAPLER	89654K	3/8 NPT IN-LINE LUBRICATION KIT
438S2-1	TACKER,S2,1-1/2 MAX	BA-T156	WM12-156 MINI CORR TOOL
438S2-2	TACKER,S2,1-1/2 MAX.	BA-T405	95/16-405 TACKER
438S2R-1	TACKER,ROOF,S2,1-1/2 MAX	BC601	LUBRICANT - 4 FL. OUNCE
438S2R-2	ROOFING,S2,1-1/2 MAX.	BC602	LUBRICANT (1) PINT
438S5-1	TACKER,S5,1-1/2 MAX.	BC603	LUBRICANT (1) PINT COLD WTHR
438S5CLPKIT	SPRG CLIP KT FRNT MAGNET	BC604	LUBRICANT 1 QUART
438S5CLPSKIT	SPRG CLP KT FRNT MAG STL STOP	BCAR1B-495-92L	BOX SPRING STAPLER
438S5CLPTBKIT	SPRG CLP KT TOP AND BOT MAG	BCAR-2S	BOX SPRING STPLR DOUBLE SHOT
438S5OSKCLPKIT	OSK SPRG CLP KT	BIGBERTA160	6 INCH TIMBER NAILER
450S2-1	TACKER,S2,2IN MAX	BT125-1	BRAD NAILER CONTACT 1-1/4 IN
538S214-1	TACKER,S2,14GA,1 MAX	BT125-2	BRAD NAILER SEQUENTIAL 1-1/4 IN
538S4-1	TACKER,S4,1-1/2IN MAX.	BT125-3	BRAD NAILER TRIGGER 1-1/4 IN
538S4-3	TACKER,S4,1-5/8IN MAX.	BT125K-2	BRAD NAILER KIT 1-1/4 IN
538S5-1	TACKER,S5,1-1/2IN MAX.	BT200-1	BRAD NAILER CONTACT 2 IN
538S5-2	TACKER,S5,1-1/2IN MAX	BT200-2	BRAD NAILER SEQUENTIAL 2 IN
650S5-3	TACKER,S5,2IN MAX	BT200-3	BRAD NAILER TRIGGER 2IN
750S4-1	TACKER,S4,2IN MAX.	BT200K-2	BRAD NAILER KIT 2 IN
750S4-2	MEDIUM DUTY TACKER	BT35B-1	BRAD NAILER CONTACT TRIP
750S4-3	MEDIUM DUTY TACKER	BT35B-2	BRAD NAILER SEQUENTIAL TRI
750S5-1	TACKER,S5,2IN MAX	BT35B-3	BRAD NAILER TRIGGER 2IN
850541K	1/4IN BLOW GUN	BT50B-1	BRAD NAILER CONTACT TRIP 2 IN
850S4-1	TACKER,S4,2IN MAX, C. T	BT50B-2	BRAD NAILER SEQUENTIAL TRIP 2 IN
851393K	3/8 HOSE SPLICER WITH 2 CLAMPS	BT50B-3	BRAD NAILER TRIGGER 2 IN



ITEM NUMBER	ITEM DESCRIPTION	ITEM NUMBER	ITEM DESCRIPTION
BTSXAF-125-KIT	AUTOFIRE KIT FOR BT125	HR-86C-100	Model 86 Light Clipping Tool, Square Blade
BTSXAF-200-KIT	AUTOFIRE KIT FOR BT200	HR-86C-110	Model 86C Light Clipping Tool
CAP1516	TRIM AIR COMPRESSOR	HR-86C-110	Model 86C Light Clipping Tool, Thin Anvil
CAP2060P	2HP, 6 GAL PANCAKE COMPRESSOR	HR-86C-170	Model 86C Light Clipping Tool, Thin and Narrow Blade and Anvil
CAP2080WB	2HP ELEC WBARROW 6 GAL	HR-88B	Model 88 Light Clipping Tool
CAP2560OL	2.5HP 6GAL OIL LUBE COMPRESSOR	HR-LN	LOCKNAIL MACHINE
CAP6080WB	6HP GAS 8 GAL WBARROW COMPR.	HR-VRC-48W	MODEL 48W
CAP60P-OF	6 GAL OIL FREE COMPRESSOR	HR-VRC-BONNELL	VRC MACHINE - BONNELL
CF15-2	CORRUGATED TOOL 1 IN WIDE SEQ.	JB600	P6C-8AD-STAPLER
D16-2	1-3/8 CROWN MAN. PKG STAPLER	LHF97125-2	LAMINATED FLOOR STAPLER
D16-2AD	1-3/8 CROWN AIR DRIVE PKG STPLR	MCF16	MITRE CLAMP TOOL
D19	1-1/4 CROWN 5/8IN MAN PKG STPLR	MCN150	PT METAL CONNECTOR TOOL 1.5 IN
D19AD	1-1/4 CROWN AIR DR 5/8IN PKG STPLR	MCN250	PT METAL CONNECTOR TOOL 1.5-2.5 IN
D19AD3/4	1-1/4 CROWN AIR DR 3/4IN PKG STPLR	MIIFN	FLOORING NAILER
D61ADC	1-3/8 CROWN COIL PKG STAPLER	MIIFOOT-KIT	KIT, PREFINISHED FLOORING
D61ADCSB	1-3/8 CR COIL SIDE STRIKE PKG STPLR	MIIFIS	FLOORING STAPLER
ESD-1175	BCAR KIT- ALUM BBL	MK2	KIT, MOUNTING S32
ESD-450S2P	450S2 16 GA TRIPLE WALL PLIER TOOL	MTCKA2	KIT, FT VLV & GUIDE KIT 1
ESD-450S2-WS	450S2-2 WITH WALKING STICK	MTCKA3	KIT, SC 50 AIR TOUCH TRIP
F21PL	PLASTIC COLLATED FRAMING NAILER	MTCKA4	KIT, SC7 SERIES FOOT VALVE
F28WW	WIRE COLLATED FRAMING NAILER	MTCKA7	KIT SC7 SERIES TOUCH TRIP
F33PT	PAPER COLLATED FRAMING NAILER	N100S	STICK NAILER
F33PTSM	PAPER TAPE SHORT MAG NAILER	N130C-2	ANGLE COIL NAILER
F84	FOOT OPER BOX STAPLER	N400C-1	HEAVY DUTY COIL NAILER (restricted)
FC9500EC	STITCHER HEAD,GOLDEN BELT	N52FN-2	FINISH NAILER SEQ. 16GA.
FC95EC	STAPLER,BOX	N57C-1	ANGLED COIL NAILER
FC95ECARM	STAPLER,GOLDEN BELT	N57C-2	ANGLED COIL NAILER
FN16250K-2	16 GA FINISH NAILER	N58C-1	COIL NAILER, PALLET
HFP9	9 GA RING FENCE PLIER	N62FN-1	15 GA ANGLED FINISH NAILER CT
HP118K	23 GAUGE HEADLESS PINNER KIT	N62FNK-2	15 GA ANGLED FINISH NLR SEQ. KIT
HR-45	MOD. 45 CLINCHING TOOL	N64084-1	COIL PALLET NAILER (restricted)
HR-45TN	MOD. 45T CLINCHING TOOL	N64099-1	COIL NAILER, PALLET (restricted)
HR-48CCP	MOD. 48 COIL CLIP TOOL W/FEED	N64C-1	COIL SIDING NAILER (WIRE)
HR-49CCP	MOD 49 COIL CLIP TOOL W/FEED	N66BC-1	BOSTITCH CAP NAILER
HR-55435	DISPENSER/TRACK ASSY	N66C-1	COIL SIDING NAILER CT
HR-55450	ASSEMBLY, COIL CLIP STAND	N66C-2	COIL SIDING NAILER SEQ
169601	AUTOMATIC AK CLIP MACHINE	N70CB-1	ANGLE COIL NAILER (restricted)
HR-55740	SEMI-AUTOMATIC AK MACHINE	N70CB-2	ANGLE COIL NAILER (restricted)
HR-55996	CLINCH CLIP REMOVAL PLIERS	N70CBPAL	PNEUMATIC PALLET NAILER (restricted)
HR-57129	SEMI AUTO TRK MACHINE	N75C-1	SHEATING NAILER
HR-57130	AUTO TRK MACHINE	N80CB-1ML	ANGLE COIL NAILER
HR-61	MOD. 61 CLINCHING TOOL	N80CBMLPAL	PNEUMATIC PALLET NAILER
HR-65002	3/8 HOSE ASSEMBLY C.C	N89C-1P	INDUSTRIAL PALLET NAILER
HR-65006	KING SIZE ROTATING TABLE	P3-IND	P3-INDUSTRIAL PLIER
HR-65007	FULL SIZE ROTATING TABLE	P50-10B	103020 CARTON CLOSING PLIER
HR-65C-130	65C Light Clipping Tool	P50-5B	5019 CARTON CLOSING PLIER
HR-66C-110	66C Light Clipping Tool, Angle Blade	P50K-1	P50 REMOTE FOOT VALVE KIT
HR-68C-100	68C Light Clipping Tool	P6C-6	STAPLING PLIER, 2619
HR-85C-100	85C Light Clipping Tool, Square Blade	P6C-8	STAPLING PLIER, 5019
HR-85C-110	Model 85C Light Clipping Tool, Angle Blade		
HR-85SB10	Model 85S10 Light Clipping Tool		

CT = Contact Trip

ST = Sequential Trip

TO = Trigger Operated

See Inside Front Cover for Details

ITEM NUMBER	ITEM DESCRIPTION
P7	COLLATED D-RING HAND PLIER
PC2K	POWERSLAM HAMMER TACKER
PN100	PALM IMPACT NAILER
PRO-14100	PROZHOZE 1/4IN X 100FT
PRO-1450	PROZHOZE 1/4IN X 50FT
PRO-14REPAIR	PROZHOZE 1/4IN REPAIR KIT
PRO-38100	PROZHOZE 3/8IN X 100FT
PRO-3850	PROZHOZE 3/8IN X 50FT
PRO-38REPAIR	PROZHOZE 3/8IN REPAIR KIT
RINGER9/16	PLIER, HAND 16 GA RING
RN46-1	ROOFING NAILER - C.T
RN46-2	ROOFING NAILER - S.T
RN90PLEX	RH DUPLEX NAILER
S32SL-1	SL STAPLER - CT
S32SL-2	SL STAPLER - ST
S32SL-3	SL STAPLER - TO
S32SX-1	SX STAPLER - CT
S32SX-2	SX STAPLER - ST
S32SX-3	SX STAPLER - TO
S3297-1	1/38 97 STAPLER - CT
S3297-3	1/38 97 STAPLER - TO
S97125-1	97 STAPLER CT
SB150SLBC-1	BOSTITCH CAP SL STAPLER
SB156SL-2	HI POWER SL STAPLER
SB156SX-2	HI POWER SX STAPLER
SB-1664FN	16 GA STRAIGHT FINISH NAILER KIT
SC50HP	TOOL, SC 50 HAND PLIER
SC50T	HOGGR 11G CRING W/TOOLBX
SC7	HOGGR 15G CRING 3/4
SC73462	HOGGR 16G CRING 3/8
SC742	HOGGR 16G CRING 3/4 SM
SC743	HOGGR 16G CRING 3/4
SC760	HOGGR 16G CRING 1/2 TIGH
SC761	HOGGR 16G CRING 1/2
SC77XE	HOGGR 15G W/EXTEXT NOSE
SC7C	HOGGR 15G CRING 3/4 TIGH
SC7E	HOGGR 15G CRING 3/4 ext.
SL1250C-2	OUTWARD CLINCH SL STAPLER
SL150-1	SL STAPLER CT
SL150-2	SL STAPLER ST
SL150-3	SL STAPLER TO
SL150LM-1	SL150 LONG MAG. CT
SL150LM-2	SL150 LONG MAG. ST
SL150LM-3	SL150 LONG MAG. TO
SX150-1	SX STAPLER CT
SX150-2	SX STAPLER ST
SX150-3	SX STAPLER TO
SX150-BHF-2	HARDWOOD FLOOR SX STAPLER
SX150K-1	SX STAPLER KIT

ITEM NUMBER	ITEM DESCRIPTION
SX150LM-3	SX150 LONG MAG. - T.O
TR201	HOGGR 15G DRING 3/4 sprn
TR203	HOGGR 15G DRING 3/4 long
TR315	HOGGR 15G DRING 3/4 long
TU-225-18HP	FINE TRIM PINNER 18 GAUGE
TVA2	TRIGGER VALVE KIT
TVA4	KIT-QUICK EXHAUST REMOTE (restricted)
TVA5	KIT,S32/BT TRIGGER VLV
TVA6	KIT,TRIGGER VALVE
TVA7	KIT,AUTOMATIC MODULE
TVA9	KIT,STANDARD MODULE
VSA2	VINYL SIDING ADAPTER



For ordering information check out the Part Number Selection Guides on Pages 46-55.

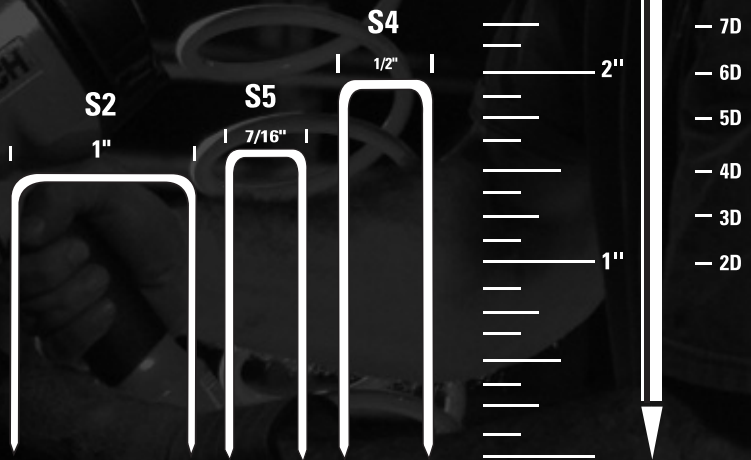

© 2008 The Stanley Works

AD4020-08

BOSTITCH[®]

STANLEY

Bostitch, East Greenwich, Rhode Island 02818

Customer Service Phone: 1-800-832-3080 Fax: 1-800-842-9360 www.BOSTITCH.com