

SCHLAGE

# B-SERIES

*Commercial Grade Auxiliary Locks*



## *Commercial Grade Auxiliary Locks*

*B600/700/800-Series are heavy duty commercial deadlocks with a wide variety of keying and security options.*

*BC100 Series is ideal for standard duty commercial and heavy duty residential applications, and also offers a wide variety of keying and security options.*

*B250-Series deadlatches are ideal as the primary lock on pool gates and doors to utility spaces.*

## *Performance Features*

**BC160 and B600/700/800-Series** locks have 1" throw deadbolts and thumbturn levers designed for easy operation.

**B250-Series** products have a 9/16" throw deadlatch for self-latching applications, with hold-back thumbturn standard.

**B600/700/800-Series** deadlocks have solid brass or bronze cylinder collars, a security shield to prevent "ice pick attacks" and hardened steel ball bearings to protect the two heavy 1/4" mounting bolts from drilling attacks.

**All B-Series** standard strikes come with wood frame reinforcer anchored with two heavy 3" screws to resist kick-in attacks and free-spinning solid or reinforced collars to resist cylinder wrenching.

See exploded views and more specific features on individual product pages 4, 6 and 8.

INDEX	
Accessories and Parts	14
BC100-Series	6, 7
B250-Series	8, 9
B600/700/800-Series	4, 5
Cylinders	10, 11
Door Preparation	4, 6, 8
Door Handling	15
Exploded Views	4, 6, 8
Finishes & Functions	5, 7, 9
How to Order	15
Interchangeable Cores	11
Latches and Bolts	12
Performance Features	4, 6, 8
Specifications	3
Strikes	13

## Specifications

### Handing:

B250-Series deadlatches are reversible. All other B-Series locksets are non-handed.

### Door Thickness:

BC100-Series, 5-pin: 1 $\frac{3}{8}$ " to 1 $\frac{3}{4}$ " thick (35mm to 44mm) standard. Available to 2 $\frac{1}{4}$ " (57mm), assembled to order.

B250-Series, 5-pin: 1 $\frac{1}{8}$ " to 1 $\frac{3}{4}$ " (35mm to 44mm) standard. Available to 2 $\frac{1}{4}$ " (57mm), assembled to order.

B600/700/800-Series: 1 $\frac{3}{4}$ " to 2" (44mm to 51mm) standard. Available for 1 $\frac{3}{8}$ " (35mm) and doors up to 2 $\frac{1}{2}$ " (63mm), assembled to order. Door ranges may vary by function.

### Backset:

BC100-Series: Adjustable for 2 $\frac{3}{8}$ " (60mm) or 2 $\frac{3}{4}$ " (70mm) standard.

B250-Series: 2 $\frac{3}{8}$ " (60mm) standard. 2 $\frac{3}{4}$ " (70mm) optional.

B600/700/800-Series: 2 $\frac{3}{4}$ " (70mm) standard, 2 $\frac{3}{8}$ " (60mm), 3 $\frac{3}{4}$ " (95mm), 5" (127mm) optional.

### Front:

Brass, bronze or stainless steel. 1 $\frac{1}{8}$ " x 2 $\frac{1}{4}$ " (29 mm x 57mm) square corner, beveled. See page 12 for options.

### Dead Bolt:

1" (25 mm) throw with saw-resistant hardened steel insert.

### Latch Bolt:

Brass,  $\frac{9}{16}$ " (14mm) throw, deadlocking on keyed and exterior functions.

### Exposed Trim:

Wrought brass, bronze or stainless steel.

Thumbturn: Pressure cast zinc, plated to match finish symbols.

### Strike:

1 $\frac{1}{4}$ " x 2 $\frac{3}{4}$ " (32mm x 70mm) with steel reinforcer and two 3" screws to resist kick-in attacks standard.

Optional strikes, lip lengths and ANSI strike box available. See page 13.

### Cylinder & Keys:

Commercial: 6-pin patented Everest C123 keyway standard with two nickel silver keys per lock.

Residential: 6-pin C keyway, keyed 5-pin.

### Keying Options:

Interchangeable core and Primus® high security cylinders. Master keying, grand master keying and construction keying.

### Warranty:

Commercial: Three-year limited.

Residential: Full mechanical lifetime.

## Certifications

### ANSI:

BC100 and B250-Series meet or exceed A156.5 Grade 2 strength and operational requirements.

B600/700/800-Series meets or exceeds A156.5 Grade 1 strength and operational requirements.

### UL / cUL:

B600/700/800-Series locks are UL10B listed *auxiliary locks* for A label single doors, 4' x 8'.

UL10B Listing optional for BC100-Series as *auxiliary locks*. Letter F and UL symbol on latch front indicate listing.

UL437 Listed locking cylinder optional: Specify Primus 20-500 Series cylinder for BC100 and B250-Series Grade 2 products, or specify B800-Series Grade 1 products.

### BC160 Deadlock 605



### B250 IC Deadlatch 626



### B660 Deadlock 625



*B600/700/800-Series Exploded View*

**B660P**

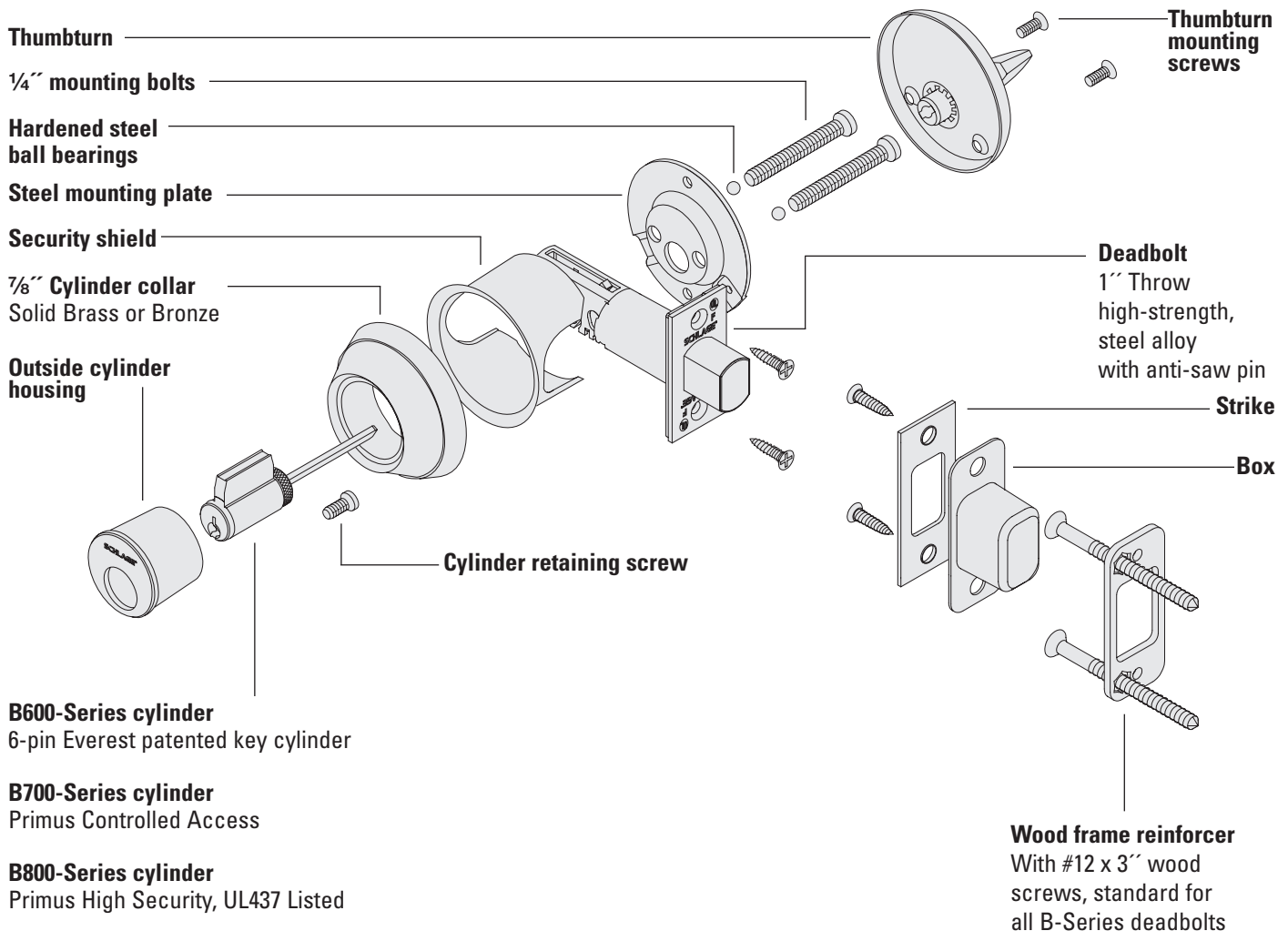

*Performance Features*

- 1" (25 mm) throw high-strength steel alloy deadbolt with hardened steel roller resists sawing and kick-in attacks.
- Precision-built solid brass 6-pin cylinders with phosphor bronze springs and nickel silver pins ensure long life and smooth operation.
- Tough nickel silver keys for smooth, long lasting operation.
- Exclusive wood frame reinforcer protects wood jamb against kick-in attacks. Reinforcer is concealed under strike and is anchored to jamb by two 3" (76 mm) screws.
- Free-spinning solid cylinder collar resists wrenching and prying.
- Large inside thumbturn makes it easy to throw and retract deadbolt.
- Metal shield protects bolt from ice-pick attack through door.
- Hardened steel balls protect mounting bolts from drill attack.

*Door Preparation*

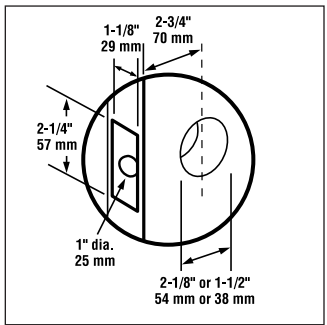

See templates.

*B600/700/800-Series Finishes & Functions*



613

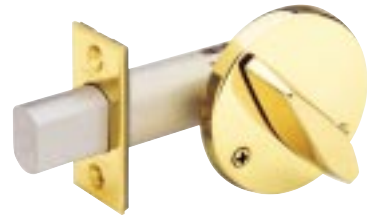

605

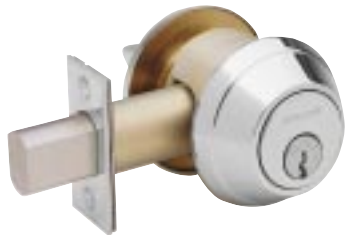

625



626

**B600-SERIES**

Schlage's toughest heavy duty Grade 1 commercial deadlock. Furnished with conventional cylinder standard. Also available with full size interchangeable core cylinder or small format interchangeable core (SFIC) cylinder.

Requires 2 1/8" (55mm) prep. UL10B listing standard for auxiliary lock on A Label fire doors.

**B700-SERIES**

Same lock as B600-Series but furnished with Primus Controlled Access cylinder for patented key control, geographical exclusivity and resistance to picking and impressioning.

Also available with Primus interchangeable core cylinder.

**B800-SERIES**

Same lock as B700-Series but Primus high security cylinder is UL437 Listed to resist drilling and other forms of physical attack.







Not available in interchangeable core.

**Finishes**

- 605 Bright Brass
- 606 Satin Brass
- 609 Antique Brass
- 612 Satin Bronze
- 613 Oil Rubbed Bronze
- 625 Bright Chromium Plated
- 626 Satin Chromium Plated

*Functions*

**ANSI A156.5 BORED DEADBOLT LOCKS**

						
	<b>Single Cylinder Deadlock</b>	<b>Double Cylinder Deadlock</b>	<b>Cylinder x Plate Deadlock</b>	<b>Classroom Deadlock</b>	<b>Cylinder Only Deadlock</b>	<b>Thumbturn Only Deadlock</b>
<b>Schlage</b>	B660P B760P B860P	B662P* B762P* B862P*	B661P B761P B861P	B663P B763P B863P	B664P B764P B864P	B680
<b>ANSI</b>	E2151 Deadbolt thrown or retracted by key outside or thumbturn inside.	E2141 Deadbolt thrown or retracted by key either side.	E2161 Deadbolt thrown or retracted by key outside. Blank plate with exposed screws inside.	E2171 Deadbolt thrown only by key outside; retracted by key outside or thumbturn inside.	E2101 Deadbolt thrown or retracted by key one side. No trim on other side.	E2191 Deadbolt thrown or retracted by thumbturn inside. No outside trim.

 B660, B661, B662, B663 available with full size or small format IC cylinders.

B760, B761, B762, B763 available with Primus full size IC cylinders.

*\*Caution: Double cylinder locks on doors that are used for exits are a safety hazard in times of emergency. Schlage does not recommend double cylinder locks in these situations. Installation should comply with local life safety codes.*

*BC100-Series Exploded View*

**BC160P**

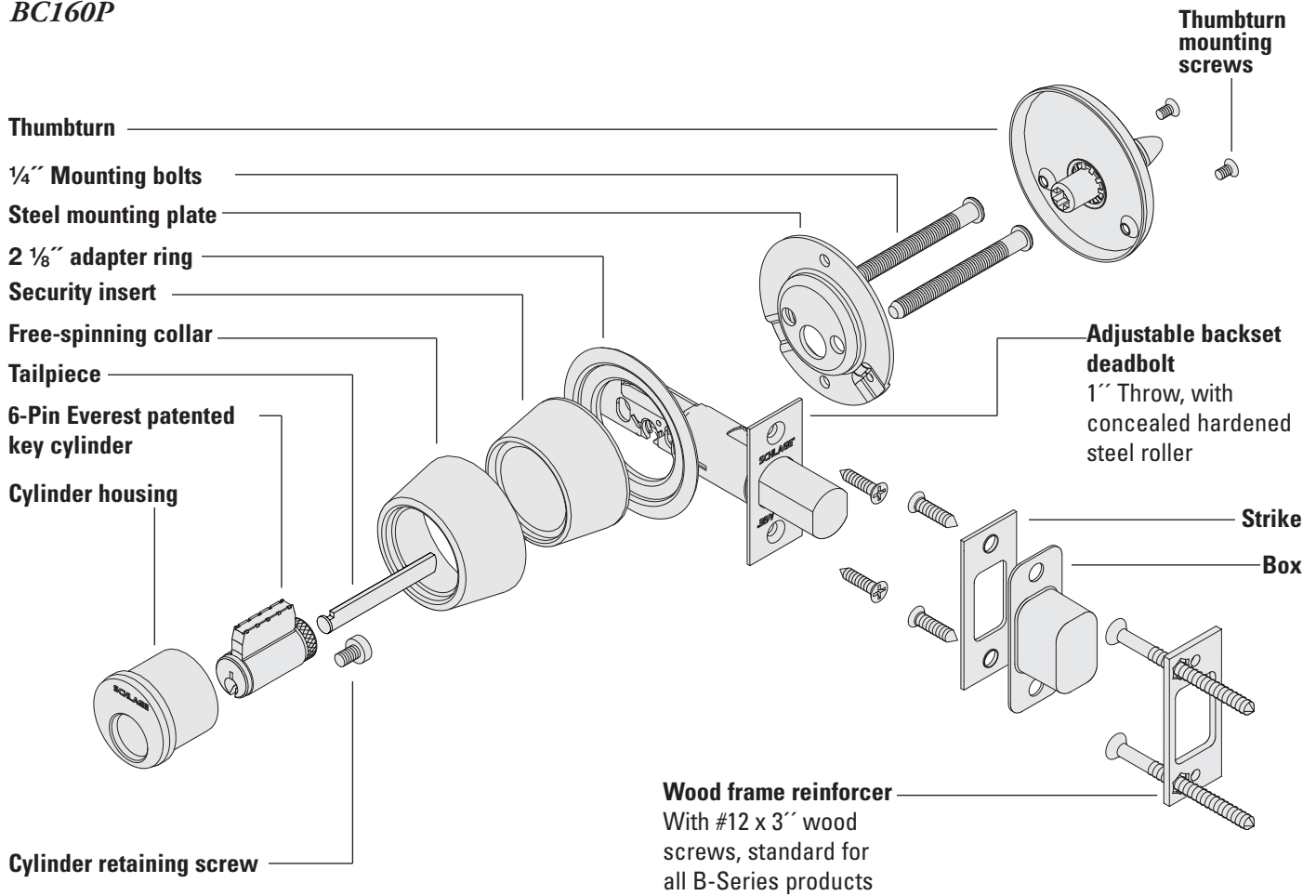

*Performance Features*

- 1" (25mm) throw bolt with hardened steel roller pin resists sawing and kick-in attacks.
- Precision-built solid brass 6-pin cylinder with phosphor bronze springs and nickel silver pins ensure long life and smooth operation.
- Tough nickel silver keys for smooth, long lasting operation
- Exclusive wood frame reinforcer protects wood jamb against kick-in attacks. Reinforcer is concealed under the strike and anchored to jamb by two 3" (76mm) screws.
- Available in three cylinder formats: standard 6-pin, Schlage interchangeable core and small format (Best and Falcon style) interchangeable core for maximum flexibility and versatility.
- Adjustable bolt fits both 2 3/8" (60mm) and 2 3/4" (70mm) backsets.
- Free-spinning cylinder collar with security insert resists crushing, wrenching and prying.

*Door Preparation*

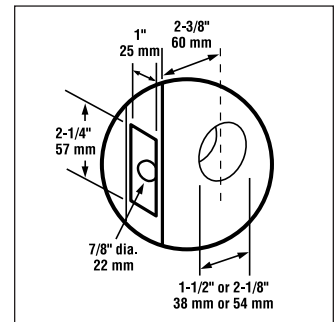

See templates.

*BC100-Series Finishes & Functions*



626

**BC100-SERIES**

A versatile and economical Grade 2 deadbolt for medium duty commercial and heavy duty residential applications. Furnished with conventional cylinder standard.

Available with Primus high security cylinder, Primus UL437 Listed high security cylinder, full size interchangeable core cylinder, Primus interchangeable core cylinder, or small format interchangeable core (SFIC) cylinder.

Designed for 1½" (38mm) prep and includes adapter(s) for 2⅞" (55mm) prep standard. UL10B listing optional for auxiliary lock on A Label fire doors.

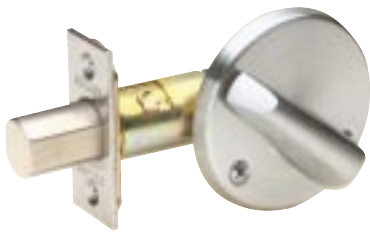





626

**Finishes**

- 605 Bright Brass
- 609 Antique Brass
- 612 Satin Bronze
- 613 Oil Rubbed Bronze
- 625 Bright Chromium Plated
- 626 Satin Chromium Plated

*Functions*

**ANSI A156.5 BORED DEADBOLT LOCKS**

	 <b>Single Cylinder Deadlock</b>	 <b>Double Cylinder Deadlock</b>	 <b>Thumbturn Only Deadlock</b>	 <b>Dummy Trim</b>
<b>Schlage</b>	BC160P	BC162P*	BC180	22-073
<b>ANSI</b>	E2152	E2142	E2192	----
<b>Description</b>	Deadbolt thrown or retracted by key outside or thumbturn inside.	Deadbolt thrown or retracted by key either side.	Deadbolt thrown or retracted by thumbturn inside. No outside trim.	Dummy cylinder outside, blank plate inside.

 All keyed functions are available for full size and small format interchangeable cores.

*\*Caution: Double cylinder locks on doors that are used for exits are a safety hazard in times of emergency. Schlage does not recommend double cylinder locks in these situations. Installation should comply with local life safety codes.*

*B250-Series Exploded View*

**B250PD**

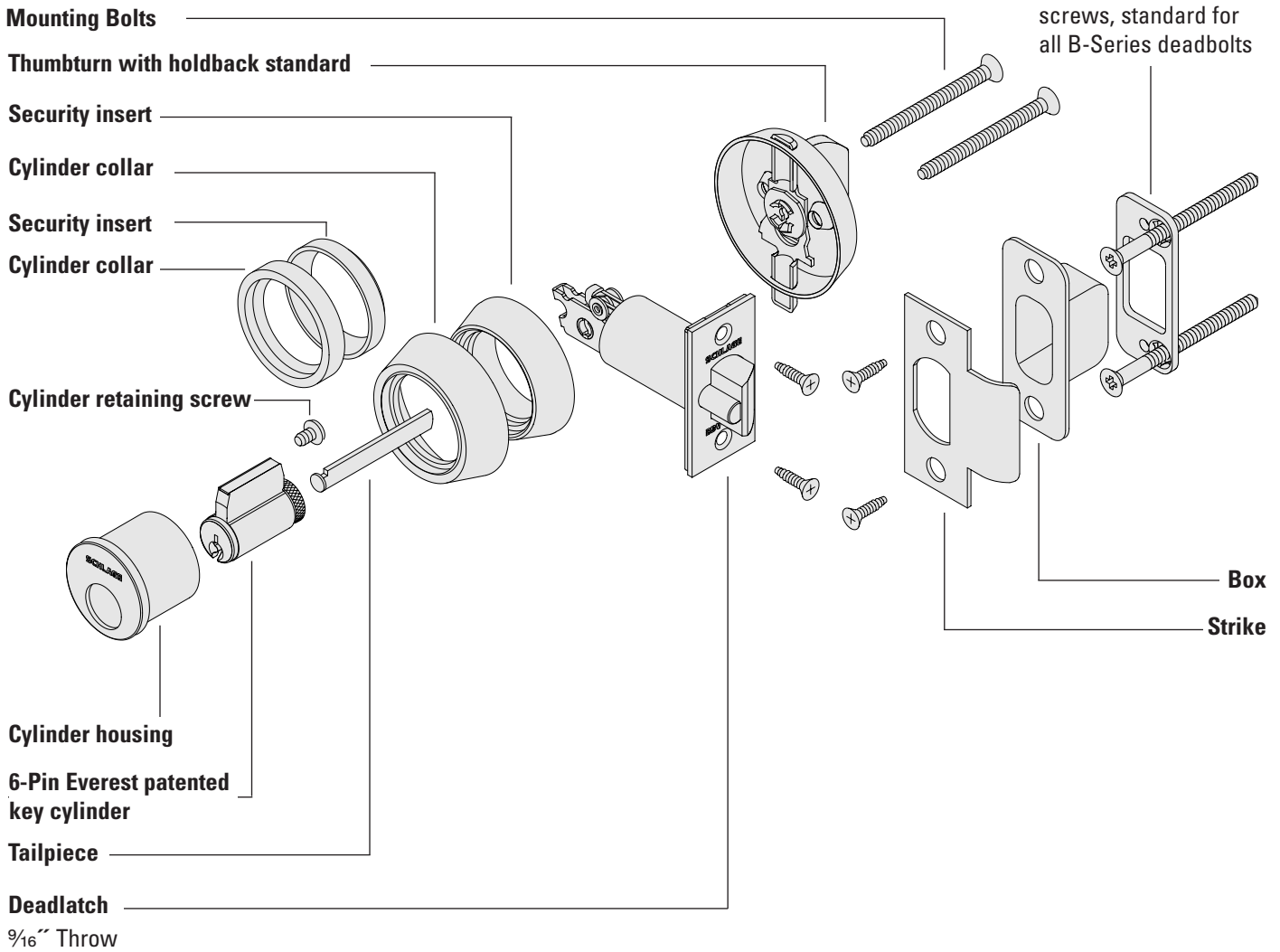

*Performance Features*

$\frac{1}{16}$ " (14mm) throw deadlatch resists pry-in attacks and "shimming" of the latch.

Precision-built solid brass 6-pin cylinders with phosphor bronze springs and nickel silver pins ensure long life and smooth operation.

Tough nickel silver keys for smooth, long lasting operation

Exclusive wood frame reinforcer protects wood jamb against kick-in attacks. The reinforcer is concealed under the strike and is anchored to the jamb by two 3" (76mm) screws.

Cylinder collar reinforced with security inserts to resist wrenching and prying.

Thumbturn "holdback" feature retains the deadlatch in a retracted position when desired.

*Door Preparation*

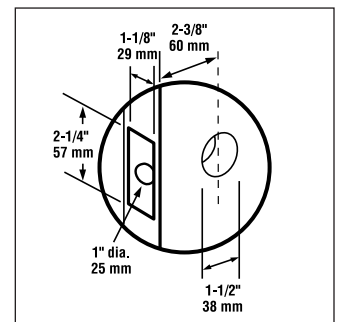

See templates.



*Finishes & Functions*

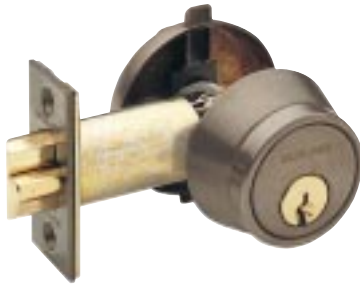

613

**B250-SERIES**

For decades considered the industry standard for tubular deadlatches, the B250-Series is ideal for pool, apartment and condominium gates, utility panels and pipe chases. Furnished with conventional cylinder standard.

Available with Primus high security cylinder, Primus UL437 Listed high security cylinder, full size interchangeable core cylinder and Primus interchangeable core cylinder.

Designed for 1½" (38mm) prep. Optional adapter plates allow easy installation in 2¼" (55mm) prep.

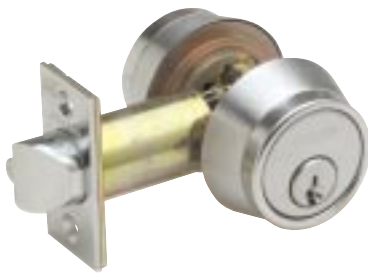



626

**Finishes**

- 605 Bright Brass
- 613 Oil Rubbed Bronze
- 626 Satin Chromium Plated

*Functions*

**ANSI A156.5 BORED DEADLOCKS**

	 <b>Single Cylinder Deadlatch</b>	 <b>Double Cylinder Deadlatch</b>	 <b>Dummy Trim</b>
<b>Schlage</b>	B250PD	B252PD*	22-015
<b>ANSI</b>	E2122	E2112	-----
<b>Description</b>	Deadlatch retracted by key outside or thumbturn inside. Holdback feature standard.	Deadlatch retracted by key either side. No holdback.	Dummy cylinder outside, blank plate inside.

 All keyed functions are available with Schlage full size IC cylinders.

*\*Caution: Double cylinder locks on doors that are used for exits are a safety hazard in times of emergency. Schlage does not recommend double cylinder locks in these situations. Installation should comply with local life safety codes.*

### Conventional Cylinders

Schlage® locks are provided with cylinders precision built to extremely close tolerances and the highest standards of accuracy. Using only solid brass plugs, extruded brass shells, phosphor bronze springs, and nickel silver keys and bottom pins, ensures long life and ease of operation.

Conventional cylinders are available in Classic keyways or in the newly patented Everest® keyways. Specify keyway to differentiate between Everest and Classic. Example: C (Classic) vs. C123 (Everest).

### Primus® Cylinders

Primus high security cylinders are available to add patented key control and varying degrees of geographical exclusivity to either Everest or Classic Schlage 6-pin key systems.

In addition to a conventional pin tumbler mechanism, Primus cylinders incorporate a patented finger pin and sidebar design providing a “dual-locking” cylinder that is virtually pick-proof. Resistance to drilling and other physical attack is optional by specifying 20-500 Series UL437 Listed cylinders.

Classic Primus cylinders are recommended for upgrading existing Classic key systems. Due to its extended patent life, the newly designed Everest Primus is recommended for new key systems and for upgrading existing Everest® key systems. Specify keyway to differentiate between Everest and Classic. Example: CP (Classic) vs. C123 (Everest).

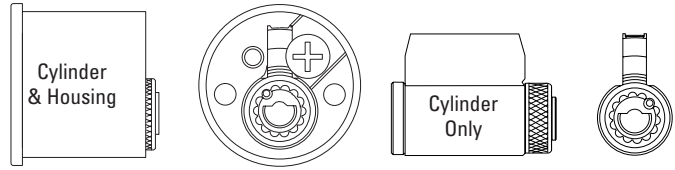

**Cylinders for B250-Series** (Order tailpieces separately.)  
This table also applies to discontinued B100, B200 and B400-Series deadlocks.

Number	Description
22-002	6-Pin conventional cylinder only
20-729	Primus cylinder only
20-529	Primus UL437 Listed high security cylinder only
22-019	6-Pin conventional cylinder in outside housing
20-730	Primus cylinder in outside housing
20-530	Primus UL437 Listed high security cylinder in outside housing
22-020	6-Pin conventional cylinder in inside housing
20-731	Primus cylinder in inside housing
20-531	Primus UL437 Listed high security cylinder in inside housing

Cylinder itself available 606 and 626 finish only. Housing is available in all B250-Series finishes.  
Everest C123 keyway standard.

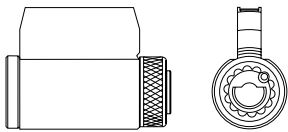

**Cylinders for BC100-Series** (Order tailpiece and housing separately.)  
This table also applies to discontinued B100, B200 and B400-Series deadlocks.

Number	Description
22-002	Conventional cylinder only
20-729	Primus cylinder only
20-529	Primus UL437 Listed high security cylinder only

Available 606 and 626 finish only. Everest C123 keyway standard.

### Dummy Cylinder (simulates cylinder in housing)

Number	Description
B610-024	B600/700/800-Series

Specify finish.  
To order BC100 and B250-Series dummy trim, see Function pages.

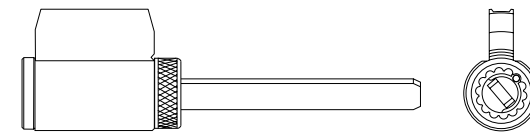

**Cylinders for B600/700/800-Series Deadlocks** (Housing not included)

Lockset Function	Cylinder Number	Door Thickness	Cylinder Mechanism		
B660, B663	22-644	1 3/8" - 2 1/2"	Conventional		
		B661, B664		22-642	1 3/8" - 2"
				22-643	2" - 2 1/2"
		B662		22-645	1 3/8" - 2"
22-646	2" - 2 1/2"				
B760, B763	20-744	1 3/8" - 2 1/2"	Primus		
		B761, B764		20-742	1 3/8" - 2"
B762	20-743			2" - 2 1/2"	
	20-745	1 3/8" - 2"			
20-746	2" - 2 1/2"				
B860, B863	20-544	1 3/8" - 2 1/2"	Primus UL437 Listed		
		B861, B864		20-542	1 3/8" - 2"
B862	20-543			2" - 2 1/2"	
	20-545	1 3/8" - 2"			
20-546	2" - 2 1/2"				

Available 606 and 626 finish only. Everest C123 keyway standard.

### Full Size Interchangeable Core

Schlage® figure-8 interchangeable core (IC) locksets allow immediate rekeying at the door simply by using the special *control key* to replace the core in seconds.

#### B600/700-SERIES

Finishes: 605, 606, 609, 612, 613, 625, 626



#### B250-SERIES

Finishes: 605, 613, 626

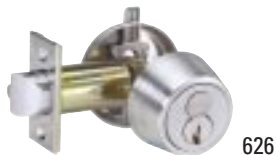

#### BC100-SERIES

Finishes: 605, 609, 612, 613, 625, 626



Available in BC100, B250, B600 and B700-Series, full size interchangeable cores can be integrated into any 5 or 6-pin Schlage key with no adverse affects on keying capacity.

To order complete locks with full size cores, change suffix from **P** to **R**. Example: BC160R, B250RD, B662R. To order locks *less core*, change suffix to **J**. To order with full size *construction core*, change suffix to **T**.

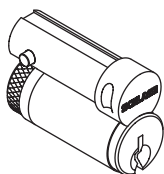

#### Full Size Interchangeable Cores and Housings

Number	Description
23-030	Conventional core
20-740	Primus core
B220-203	BC100-Series outside housing less core
B220-201*	BC162 inside housing less core
22-061	B250-Series outside housing less core
22-062	B252 inside housing less core
B610-027	B600/700-Series outside housing less core
B610-028*	B662/762 inside housing less core

\* Inside housing has no finish. Order finished faceplate B610-031 separately.

Cores available 606 and 626 finish only. Housings available in the same finishes as corresponding complete locks.

Everest C123 keyway standard.

### Small Format Interchangeable Core (SFIC)

Available in BC100 and B600-Series, the small format IC option is designed for Schlage Everest B Family restricted keyway cores and is also completely compatible with Best®, Falcon, etc. small format cores.

To order complete locks with Everest B Family *restricted keyway cores*, change product suffix from **P** to **GD** and provide letter of authorization from end user. Example: B660GD. To order locks *less core*, change suffix to **BD**.

To order with *keyed brass construction cores*, change suffix to **HD**. To order with *disposable plastic construction cores*, change suffix to **BDC**.

#### Small Format Core

#### Disposable Construction Core

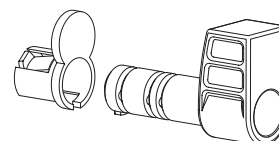
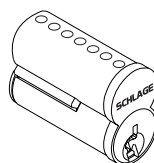

Number	Description
80-036	7-Pin uncombined Everest B Family restricted keyways
80-037	7-Pin combined Everest B Family restricted keyways
80-043	6-pin uncombined Falcon / Best keyways
80-033	7-pin uncombined Falcon / Best keyways
M204-152	Disposable plastic construction core
B610-282	BC100, B600/700-Series outside housing less core
B610-281*	BC162, B662/772 inside housing less core and faceplate

\* Inside housing has no finish. Order finished faceplate B610-014 separately.

Cores available 606 and 626 finish only. Housings available in the same finishes as corresponding complete locks.

80-033 and 80-043 cores are available in Best A, D, E, F, G, H, J, K, L, and M keyways. Specify keyway by suffixing "B" to keyway letter, e.g. "AB".

80-036 and 80-037 restricted keyway cores require a letter of authorization from the end user. Schlage assigns the keyway when establishing new Everest restricted key systems.

## Latches and Bolts

B-Series bolt and latch fronts are adjustable for flt or beveled edge doors and furnished in brass, bronze or chrome finishes compatible with the lock finish. When ordering separately, specify quantity, part number and finish.

### BC100-Series Bolts

**Square Corner Bolt    Radius Corner Bolt    Circular / Drive in Bolt**

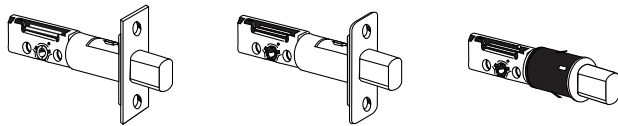

### Triple Action Bolt

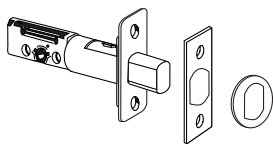

Backset	Description	Housing	Number
Adjustable: 2 <sup>3</sup> / <sub>8</sub> " or 2 <sup>3</sup> / <sub>4</sub> "	1" x 2 <sup>1</sup> / <sub>4</sub> " - square corner	7/8"	12-274
	1" x 2 <sup>1</sup> / <sub>4</sub> " - 1/4" radius corner	7/8"	12-269
	Triple option*	7/8"	12-270
	Circular / drive-in (626 only)	1"	12-268
	1 <sup>1</sup> / <sub>8</sub> " x 2 <sup>1</sup> / <sub>4</sub> " - square corner	1"	12-280**
	1" x 2 <sup>1</sup> / <sub>4</sub> " - square corner UL	7/8"	12-255

\* Includes: square corner, 1/4" radius and drive-in faceplates

\*\* Includes A501-878 faceplate adapter and G506-815 sleeve.

### B250-Series Deadlatches

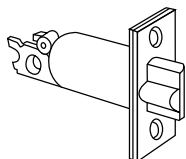

Backset	Description	Housing	Number
2 <sup>3</sup> / <sub>8</sub> "	1 <sup>1</sup> / <sub>8</sub> " x 2 <sup>1</sup> / <sub>4</sub> " - square corner standard	1"	12-100
2 <sup>3</sup> / <sub>4</sub> "	1 <sup>1</sup> / <sub>8</sub> " x 2 <sup>1</sup> / <sub>4</sub> " - square corner	1"	12-103

### B600-Series Bolts

**Square Corner Bolt**

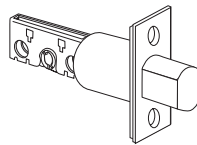

**Circular / Drive-in Bolt**

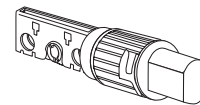

Backset	Description	Housing	Number
2 <sup>3</sup> / <sub>8</sub> "	1 <sup>1</sup> / <sub>8</sub> " x 2 <sup>1</sup> / <sub>4</sub> " - square corner	1"	12-630
	Circular / drive-in (626 only)	1 <sup>1</sup> / <sub>16</sub> "	12-640
2 <sup>3</sup> / <sub>4</sub> "	1 <sup>1</sup> / <sub>8</sub> " x 2 <sup>1</sup> / <sub>4</sub> " - square corner	1"	12-631
	Circular / drive-in (626 only)	1 <sup>1</sup> / <sub>16</sub> "	12-641
3 <sup>3</sup> / <sub>4</sub> "	1 <sup>1</sup> / <sub>8</sub> " x 2 <sup>1</sup> / <sub>4</sub> " - square corner	1"	12-632
	Circular / drive-in (626 only)	1 <sup>1</sup> / <sub>16</sub> "	12-642
5"	1 <sup>1</sup> / <sub>8</sub> " x 2 <sup>1</sup> / <sub>4</sub> " - square corner	1"	12-633
	Circular / drive-in (626 only)	1 <sup>1</sup> / <sub>16</sub> "	12-643

### Latch Front Adapter A501-878

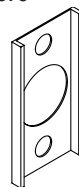

Used to convert 1" wide square front faceplates for 1<sup>1</sup>/<sub>8</sub>" wide door preparations. Furnished in black plastic. Order in units of 100 each.

### Door Reinforcement

Schlage 37-001 reinforcing unit is used to reinforce and help prevent the collapse of hollow metal doors when locksets are tightly mounted.

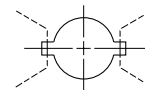

This kit should be used with long backsets in hollow metal doors to prevent lateral movement of the latchbolt.

Specify door thickness, 1<sup>3</sup>/<sub>8</sub>" or 1<sup>3</sup>/<sub>4</sub>", when ordering reinforcement kits.

### Reinforcement Kit 37-001

**Sleeve**  
A501-567

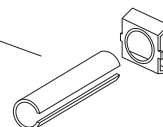

**Reinforcement**

A501-566 for 1<sup>3</sup>/<sub>4</sub>" doors  
or  
A501-565 for 1<sup>3</sup>/<sub>8</sub>" doors

## Strikes

All B-Series strikes are fully reversible for right handed and left handed doors and are furnished complete with screws. Strike boxes are also included with all standard strikes. B-Series deadbolt strikes are also packed with our exclusive wood frame reinforcer for added protection against "kick-in" attack.

### Standard Strike

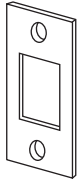

### Strike Box



### Drive-In Strike

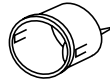

### Strikes for Deadbolts

Number	Lip Length	Description
10-055	—	1 1/8" x 2 3/4" x 3/32" Square Corner, B600/700/800
10-064	—	1 3/16" Circular drive-in
10-087	1 3/16"	1 1/4" x 4 7/8" ANSI
10-092	1 1/8"	1 5/8" x 2 1/4" Radius round corner
10-094	—	1 1/8" x 2 3/4" x 3/32" Square Corner, BC100
10-095	1 1/8"	1 5/8" x 2 1/4" Full lip, no box
B250-283	—	Box for standard strike

### Strikes for Deadlatches

Number	Lip Length	Description
10-001	1", 1 1/8", 1 1/4", 1 1/2" 1 3/16", 1 3/4"	1 1/8" x 2 3/4" Square Corner
10-004	1 1/8"	1 1/8" x 2 3/4" Radius round corner
10-025	1 3/16", 1 3/8"	1 1/4" x 4 7/8" ANSI
C603-623	—	Box for T-strike
K510-066	—	Box for ANSI strike

### Rabbeted Latch and Strike Kit

39-030

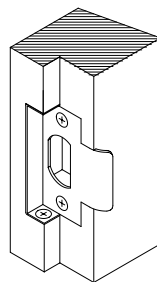
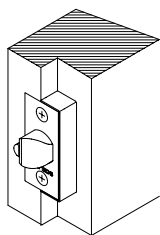

The rabbeted latch and strike kit adapts square corner latches and strikes for 1/8" rabbeted door and frame preparations.

Finishes: 605 and 626 only.

### Wood Frame Reinforcer

37-016

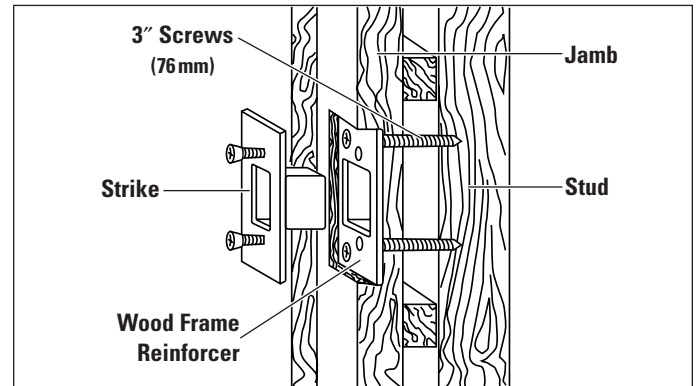

Furnished with standard and round corner deadbolt strikes, this reinforcer significantly strengthens a jamb against "kick-in" attack and greatly increases the security of the lock. The reinforcer is concealed under the strike and is anchored to the jamb with two 3" long screws.

## Thumbturn Assemblies and Inside Plate



**B220-004**  
BC160



**B202-672**  
B250 with holdback  
(standard)

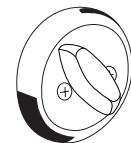

**B202-671**  
B250 without holdback



**12-617** for B660/760/860  
**12-618** for B663/763/863



**12-626**  
B661/761/861

*Accessories and Other Parts*

**Adapters for BC100 and B250-Series in 2 1/8" Prep** (Specify finish.)



**38-031**  
For cylinder

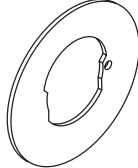

**38-032**  
For B250 thumbturn



**38-018**  
Thin door spacer fits under 38-031 adapter for BC100 and B250-Series.

**38-016** Kit for BC162 and B252 contains two 38-031 adapters

**38-017** Kit for B250 contains one 38-031 and one 38-032 adapter



**Inside Cylinder Faceplates for BC162 and B662/762/862** (Specify finish.)

Number	Cylinder Type
B600-092	Non-IC
B610-031	Full size IC
B610-014	Small format IC

**Cylinder Collars and Security Inserts**

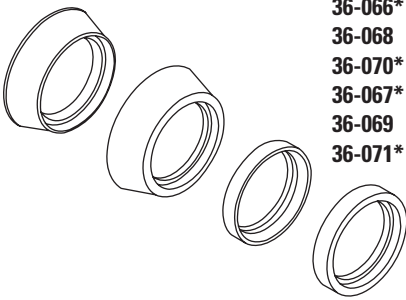

**B100, B200, B400-Series**

- 36-066\*** 1/8" collar
- 36-068** 1/8" security insert
- 36-070\*** 1/8" collar with insert
- 36-067\*** 7/16" collar
- 36-069** 7/16" security insert
- 36-071\*** 7/16" collar with insert

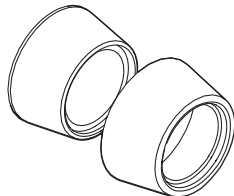

**B250-Series IC and all BC160-Series**

- 36-086\*** 1" collar
- 36-084** 1" security insert
- 36-085\*** 1" collar with insert

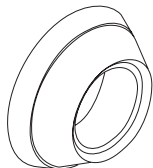

**B600/700/800-Series**

- B600-015\*** 7/8" for non-IC cylinders on doors 1 5/8" and thicker
- B600-016\*** 1 1/8" for all other applications

\* Specify finish.

*Tailpieces*

**BC100-Series Tailpieces (Non-IC Models)**

Function	Door Range	Tailpiece
BC160P	1 3/8" – 1 3/4" (35 mm – 44 mm)	B202-557
	>2" – 2 1/4" (>51 mm – 58 mm)	B502-999
BC162P	1 3/8" – 1 3/4" (35 mm – 44 mm)	B202-269
	>2" – 2 1/4" (>51 mm – 58 mm)	B220-036

Two each required for BC162P.

**B250-Series Tailpieces (Non-IC Models)**

Function	Pins	Door Range	Tailpiece
B250	5 or 6	1 3/8" – 2 3/4" (35 mm – 70 mm)	B202-558
B252	5 or 6	1 3/8" – 1 3/4" (35 mm – 44 mm)	B202-370
	6	2", 2 3/4" (51 mm, 70 mm)	
	6	2 1/4", 2 1/2" (58 mm, 64 mm)	B202-269
	5	2 1/2" (64 mm)	B202-453

Two each required for B252

**B600/700/800-Series Tailpiece & Retainer Packs (Non-IC)**

Function	Door Range	Classic Convent'l	All Others
B660/760/860, B663/763/863	1 3/8" – 2 1/2" (35 mm – 64 mm)	B610-044	B610-084
B662/762/862 (dbl. cylinder)	1 3/8" – 2" (35 mm – 51 mm)	B610-045	B610-085
	>2" – 2 1/2" (>51 mm – 64 mm)	B610-046	B610-086
B661/761/861, B664/764/864	1 3/8" – 2" (35 mm – 51 mm)	B610-042	B610-082
	>2" – 2 1/2" (>51 mm – 64 mm)	B610-043	B610-083

Two each required for double cylinder locks

**B-Series Interchangeable Core Tailpieces**

Function	Tailpiece
BC160BD	B202-957
BC160J, B660J, B661J, B663J	B600-041
BC162BD	B202-453
BC162J, B662J (two tailpieces required)	B600-040
B660BD, B663BD	B202-557
B661BD	B220-032
B662BD (two tailpieces required)	B202-370
B662BD thick door (two tailpieces required)	B202-453

B600R and B700R-Series use the same tailpieces as listed for B600J-Series.

## Door Handing

Schlage BC160 and B600/700/800-Series locks are non-handed. B250-Series deadlatches are reversible. Hand information is only necessary to ensure proper finish of latchbolt and strike for split-finish locks. Follow the diagram to correctly determine the hand of the door.

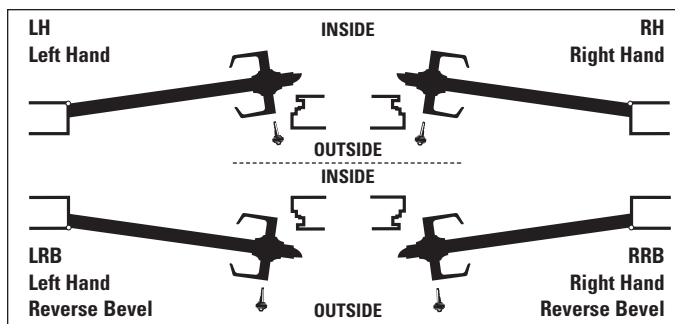





## How to Order

To order Schlage products, descriptive data should be in the same sequence as shown.

Line Item	Qty	Product	Outside	Inside	Hand	Latch	Strike	Door Thickness	Dim	Additional Details
			Finish	Finish						
1	2	3	4	5	6	7	8	9	10	11

- 1 Line item number
- 2 Quantity
- 3 Complete model number with function and cylinder type

To order cylinder options, change “P” at the end of the model number as follows:

	BC160P	Standard
	BC160L	Less standard cylinder (For BC100 and B250-Series with Primus cylinder, specify this option and order Primus cylinder separately.)
	B250JD	Prepared for full size interchangeable core, less core (For BC100 and B250-Series with Primus core, specify this option and order Primus core separately.)
	B250RD	With full size conventional interchangeable core installed. Order control keys separately.
	B250TD	With full size (temporary) construction core installed. Order all keys separately.
	B660BD	Prepared for small format (Falcon, Best, etc.) interchangeable core (SFIC), less core.
	B660GD	With Everest B Family restricted keyway small format core installed. Order control keys separately.
	B660HD	With small format keyed brass (temporary) construction core installed. Order all keys separately.
	B660BDC	With small format disposable plastic construction core installed.

- 4 Outside finish.
- 5 Inside finish. Leave blank if same as outside.
- 6 Hand (Required only for split-finish locks)
- 7 Latch or bolt. Leave blank for standard or specify part number for optional latch or bolt. LLL=Less Latch.
- 8 Strike. Leave blank for standard or specify part number for optional strike. LLL=Less Strike.
- 9 Door thickness. For B-Series thick door applications, door must be extended equally.
- 10 Dimension for strike lip lengths. See strike page for availability of specific dimensions with specific strikes.
 

100 = 1"	138 = 1 3/8"	134 = 1 3/4"
118 = 1 1/8"	112 = 1 1/2"	200 = 2"
114 = 1 1/4"		
- 11 Additional details (e.g. key symbol, keyway, bitting) and other special requirements.

### Example

Line Item	Qty	Product	Outside	Inside	Hand	Latch	Strike	Door Thickness	Dim	Additional Details
			Finish	Finish						
1	100	B660P	626			12-630		2"		KA4

**Note:** Schlage order forms are available at no charge by contacting your IR Security & Safety Consultant or Customer Service.

  
**Administrative Offices**

1915 Jamboree Drive, Suite 165  
Colorado Springs, CO 80920  
(719) 264-5300  
FAX (719) 264-5382

**Commercial Customer Service**

2315 Briargate Parkway, Suite 700  
Colorado Springs, CO 80920  
(800) 847-1864  
FAX (800) 452-0663  
Order Entry  
FAX (800) 452-0665

**Residential Customer Service**

1010 West Santa Fe  
Olathe, KS 66061  
(888) 805-9837

**International Division**

Ingersoll-Rand Architectural Hardware  
1076 Lakeshore Road East  
Mississauga, Ontario, L5E 1E4, Canada  
(905) 278-6128  
FAX (905) 278-1413

**Internet**

<http://www.schlage.com>

**Fax-On-Demand**

(888) 321-3228

**IR Security & Safety Americas**

111 Congressional Boulevard  
STE 200  
Carmel, IN 46032  
800-847-1864  
800-452-0663 Fax  
[www.irsecurityandsafety.com](http://www.irsecurityandsafety.com)

An  **Ingersoll-Rand** business

 **Security & Safety**  
Proven Source. Proven Solutions.™